

OPERATING MANUAL

XPT800

Sound Level Meter and
Spectrum Analyzer



EN
V1.5



Contents

| | | |
|----------|--|-----------|
| 1 | Information | 8 |
| 1.1 | General information | 8 |
| 1.2 | Safety information | 9 |
| 2 | Compliance and directives | 11 |
| 3 | Identification | 13 |
| 3.1 | Product identification | 13 |
| 3.2 | Part numbers of main components and accessories | 13 |
| 3.3 | Explanation of product code | 13 |
| 4 | Description of the instrument | 15 |
| 4.1 | Basic features | 15 |
| 4.2 | Possible applications | 16 |
| 4.3 | Main features | 16 |
| 4.4 | Performance characteristics | 17 |
| 4.5 | Instrument hardware overview | 18 |
| 4.6 | Description of main components | 19 |
| 4.6.1 | Microphone | 19 |
| 4.6.2 | Preamplifier | 20 |
| 4.6.3 | Instrument | 20 |
| 4.6.4 | Outdoor microphone unit (optional) | 22 |
| 4.7 | Display | 23 |
| 4.7.1 | Icon menu | 24 |
| 4.7.2 | Status Bar | 25 |
| 4.7.3 | Control Bar | 27 |
| 4.7.4 | Context menu | 28 |
| 4.8 | Navigation and selection | 28 |
| 4.9 | Keyboard | 29 |
| 4.10 | Entering text and numbers | 29 |
| 5 | Pre-use checks and operations | 30 |
| 5.1 | Unpacking and inspection | 30 |
| 5.2 | Standard configuration | 30 |
| 5.3 | Options and accessories | 32 |
| 5.3.1 | Hardware accessories | 32 |
| 5.3.2 | Hardware options | 32 |
| 5.3.3 | Firmware options | 34 |
| 5.3.4 | Software options | 35 |
| 5.3.5 | Hardware Upgrades | 36 |
| 5.4 | Assembling and disassembling components | 37 |
| 5.4.1 | Microphone and preamplifier | 37 |
| 5.4.2 | Windscreen | 38 |
| 5.4.3 | Outdoor microphone unit | 38 |
| 5.4.4 | Connect the outdoor microphone unit to the sound level meter | 39 |
| 5.4.5 | Mounting on a tripod | 40 |
| 5.5 | Battery power supply | 40 |
| 5.5.1 | Battery power use | 40 |
| 5.5.2 | Charging the battery | 41 |
| 5.5.3 | Battery insertion and replacement | 43 |
| 5.6 | External power supply | 44 |
| 6 | Switching on and off | 45 |
| 6.1 | Switching on | 45 |
| 6.1.1 | Automatic power-up and scheduled logging start | 45 |
| 6.2 | Display auto-off function | 46 |

| | | |
|-----------|---|-----------|
| 6.3 | Switching off..... | 47 |
| 6.3.1 | Auto Power-OFF..... | 47 |
| 7 | Settings and Adjustments..... | 48 |
| 7.1 | Set current date and time..... | 48 |
| 7.2 | Using NTP server to synchronize date and time..... | 49 |
| 7.3 | Setting the language..... | 49 |
| 7.4 | Display adjustments..... | 50 |
| 7.4.1 | Adjusting the brightness..... | 50 |
| 7.4.2 | Setting the display auto power off..... | 51 |
| 7.4.3 | Selecting the display theme..... | 51 |
| 7.4.4 | Turning the TOUCH display on and off..... | 52 |
| 8 | Viewing modes..... | 53 |
| 8.1 | SLM view..... | 55 |
| 8.2 | TABLE view..... | 56 |
| 8.3 | Octave and Third Octave..... | 58 |
| 8.4 | Time History..... | 60 |
| 8.5 | Spectrogram..... | 61 |
| 8.6 | FFT..... | 62 |
| 8.7 | Statistics..... | 64 |
| 8.8 | Activating or deactivating views..... | 65 |
| 9 | Getting started: Main Functions..... | 66 |
| 9.1 | Calibration..... | 66 |
| 9.2 | Setting the duration of a measurement..... | 67 |
| 9.3 | Select acoustic parameters to be displayed..... | 68 |
| 9.4 | Set acoustic parameters to be stored..... | 69 |
| 9.5 | Subtraction of two acoustic parameters..... | 72 |
| 9.6 | Load a custom configuration..... | 73 |
| 9.7 | Set alarms on exceedances..... | 74 |
| 9.8 | Starting and stopping a measurement..... | 76 |
| 9.9 | Starting and stopping a measurement with datalogging..... | 77 |
| 9.10 | Recording audio manually..... | 78 |
| 9.11 | Manually add markers to the measurement..... | 79 |
| 10 | Advanced functions..... | 80 |
| 10.1 | Setting the calibration parameters..... | 80 |
| 10.1.1 | Setup..... | 80 |
| 10.1.2 | Calibrations History..... | 81 |
| 10.2 | Setting triggers..... | 82 |
| 10.3 | Setting audio recording parameters..... | 83 |
| 10.3.1 | Audio recording mode..... | 83 |
| 10.3.2 | Audio recording resolution..... | 84 |
| 10.3.3 | Audio recording sampling frequency..... | 84 |
| 10.3.4 | Setting a duration limit to audio recordings..... | 84 |
| 10.4 | Custom measurement setups..... | 85 |
| 10.4.1 | “Current” Configuration..... | 85 |
| 10.4.2 | Load, Edit, Save as, Delete functions..... | 85 |
| 10.4.3 | “Lock” and “Auto-Load” attributes..... | 87 |
| 10.5 | Customizing markers..... | 87 |
| 10.6 | Continuous measurements datalogging..... | 88 |
| 10.6.1 | Recording Configuration..... | 88 |
| 10.6.2 | Continuous datalogging of <i>Time History</i> group..... | 89 |
| 10.6.3 | Continuous datalogging of <i>Reports</i> group..... | 90 |
| 10.6.4 | Datalogging of <i>Events</i> group..... | 90 |
| 10.6.5 | Recording <i>Globals</i> group..... | 90 |
| 10.7 | Playback and Generator..... | 91 |

| | | |
|-----------|--|------------|
| 10.7.1 | Playback management..... | 91 |
| 10.7.2 | Generator management..... | 91 |
| 10.8 | Activating the preamplifier heater..... | 93 |
| 10.9 | Monitor..... | 94 |
| 10.10 | Automatic Detectors..... | 95 |
| 10.10.1 | Tones detector according to D.M. 16 marzo 1998..... | 96 |
| 10.10.2 | Tones detector according to ISO1996..... | 97 |
| 10.10.3 | Impulses detector according to D.M. 16 marzo 1998..... | 99 |
| 10.10.4 | Impulses detector according to ISO1996..... | 100 |
| 10.11 | Spectral Analysis with Bandpass filter..... | 103 |
| 10.11.1 | Settings..... | 104 |
| 10.11.2 | Graphic Output..... | 104 |
| 10.11.3 | Storage of results..... | 104 |
| 10.12 | Statistics and Percentile Levels..... | 105 |
| 10.13 | FFT Spectral Analysis..... | 106 |
| 10.13.1 | Settings..... | 106 |
| 10.13.2 | Graphic Output..... | 106 |
| 10.13.3 | Storage of results..... | 106 |
| 10.14 | Reverberation Time..... | 109 |
| 10.14.1 | RT60 settings..... | 113 |
| 10.14.2 | RT60 measurement..... | 115 |
| 10.14.3 | Graphic Output..... | 116 |
| 10.14.4 | Storage of Results..... | 117 |
| 10.15 | Room Criteria..... | 119 |
| 10.15.1 | NC (Noise Criteria)..... | 119 |
| 10.15.2 | NR (Noise Rating)..... | 119 |
| 10.15.3 | RNC (Room Noise Criteria)..... | 120 |
| 10.15.4 | RC (Room Criteria)..... | 120 |
| 10.15.5 | Measurement..... | 121 |
| 10.16 | STI/STIPA..... | 122 |
| 10.16.1 | Settings..... | 123 |
| 10.16.2 | Measurement and Graphic Output..... | 124 |
| 10.16.3 | Storage of results..... | 126 |
| 10.17 | Screenshots..... | 127 |
| 10.18 | Notifications and automatic updates..... | 128 |
| 11 | Managing measurement data files..... | 130 |
| 11.1 | Setting the data file storage unit..... | 130 |
| 11.1.1 | Saving data to an external USB-C drive..... | 130 |
| 11.2 | Information on data file naming..... | 131 |
| 11.2.1 | Parameter Log_sequence = OFF..... | 131 |
| 11.2.2 | Parameter Log_sequence = ON*..... | 131 |
| 11.3 | Using the data file Archive..... | 132 |
| 11.3.1 | Selecting measurements to display..... | 132 |
| 11.3.2 | Displaying Globals measurements..... | 133 |
| 11.3.3 | Displaying History and Reports measurements..... | 133 |
| 11.3.4 | Manual cloud synchronisation of data files..... | 135 |
| 11.3.5 | Entering a voice note to the measurement..... | 135 |
| 11.3.6 | Renaming and deleting a data file..... | 135 |
| 11.4 | Saving of data files..... | 136 |
| 11.4.1 | Saving on PC..... | 136 |
| 11.4.2 | Data storage on Cloud..... | 136 |
| 11.4.3 | Automatic cloud synchronisation of data files via Push option..... | 137 |
| 12 | Network and connections..... | 140 |
| 12.1 | Network Settings..... | 140 |

| | | |
|-----------|---|------------|
| 12.2 | Connecting to a WiFi network | 140 |
| 12.3 | Connecting to an Ethernet port | 142 |
| 12.4 | Connecting through GSM network | 143 |
| 12.4.1 | Installing a SIM card | 143 |
| 12.4.2 | Network Settings | 144 |
| 12.5 | Connecting to a PC with USB interface | 144 |
| 13 | Firmware update and options..... | 146 |
| 13.1 | Firmware version | 146 |
| 13.2 | Firmware update | 147 |
| 13.2.1 | Wi-Fi firmware update..... | 148 |
| 13.3 | Instrument recovery via recovery firmware | 149 |
| 13.4 | Enabling or disabling instrument software options | 149 |
| 13.4.1 | Verifying the options installed in your device..... | 149 |
| 13.4.2 | Enabling new purchased options | 150 |
| 14 | Maintenance Operations..... | 151 |
| 14.1 | Cleaning the Instrument | 151 |
| 14.2 | Microphone cleaning (microphone diaphragm)..... | 151 |
| 14.3 | Accredited periodical calibration | 151 |
| 15 | Troubleshooting Guide | 152 |
| 15.1 | Formatting eMMC memory (FORMAT) | 152 |
| 15.2 | Restoring Parameters to Default Settings (Reset)..... | 153 |
| 15.3 | Malfunctions, causes and possible solutions | 153 |
| 16 | Long-term storage..... | 155 |
| 17 | Spare parts..... | 156 |
| 18 | Appendix A – Technical Specifications | 157 |
| 19 | Appendix B – Parameters..... | 160 |
| 19.1 | Measure Parameters | 160 |
| 19.1.1 | Parameters Classes | 160 |
| 19.1.2 | Composition of Acoustic parameters Labels..... | 161 |
| 19.1.3 | Classes of measurement parameters available for visualisation | 162 |
| 19.1.4 | Classes of measurement parameters available for storage..... | 163 |
| 19.1.5 | Types of parameters available for screens (views) | 163 |
| 19.1.6 | Types of parameters available for storage..... | 164 |
| 19.2 | Setup Parameters | 164 |
| 20 | Appendix C – Trigger..... | 167 |
| 20.1 | Exceedances settings..... | 168 |
| 20.1.1 | Exceedance of SLM parameters | 168 |
| 20.1.2 | Exceedance SLM mode (Exc_slm_mode) | 169 |
| 20.1.3 | Exceedance SLM thresholds (Exc_slm_threshold) | 171 |
| 20.1.4 | SLM exceedance duration filter (Exc_slm_duration) | 171 |
| 20.1.5 | Enabling SLM exceedances (Exc_slm_enable) | 171 |
| 20.2 | Setup trigger | 171 |
| 20.2.1 | Pre-trigger | 171 |
| 20.2.2 | Post-trigger duration..... | 171 |
| 20.2.3 | Retrigger | 171 |
| 20.3 | INPUT 172 | |
| 20.3.1 | SLM 172 | |
| 20.3.2 | MRK172 | |
| 20.3.3 | MIX 172 | |
| 20.4 | Setting exceedances of a spectrum in octave or third octave bands | 173 |
| 20.4.1 | Enabling Spectrum exceedances | 174 |
| 20.5 | Trigger I/O Input..... | 174 |
| 20.5.1 | TRGOUT polarity..... | 174 |

| | | |
|-----------|---|------------|
| 20.5.2 | TRIGIN polarity | 174 |
| 20.5.3 | TRGOUT Mode | 174 |
| 21 | Appendix D - File system information | 175 |
| 21.1 | XPT80X_SLM_Config..... | 175 |
| 22 | Appendix E – Serial Interface | 176 |
| 22.1 | COM commands..... | 176 |
| 23 | Declaration of Conformity | 178 |

1 Information

1.1 General information

Properties of information

- Copyright © 2023, Senseca Italy Srl
- All rights reserved in all countries.
- Any distribution, modification, translation, or reproduction of parts or all of the document is prohibited unless authorized in writing by Senseca Italy Srl.
- Senseca Italy Srl reserves the right to make changes or corrections to the relevant documentation without prior notice.
- Data, figures and descriptions contained in the manual cannot be legally enforced.
- Requests for permissions, copies, or technical information regarding this manual should be addressed to:

Senseca Italy Srl - Via Marconi 5 - 35030 Selvazzano Dentro (PD) - ITALY
Phone +39 049 8977150 / email: info@senseca.com

Version info

Firmware

Fw: 0525V167

Fw metr.: 2.4_1.2

Fw GUI: V138

Fw WiFi: 25_25

Use of the manual

Please read this manual carefully before using the instrument and keep all safety directions and instructions for future use.

- This instruction manual is an integral part of the instrument and should be kept throughout its life.
- It must be stored so that it is accessible to operators, in a clean place, and maintained in good condition.
- If the manual is lost or damaged, you can download the PDF version from www.senseca.com, on the model page in the product section.
- When transferring the instrument, always attach the instruction manual.

Symbols in the manual

To call the attention of users for the purpose of correct and safe use of the instrument, the following graphic symbols are adopted in this manual:



Info

To indicate particularly useful and important information in reading and understanding the manual.



Notice!

To signal a situation or practice that requires caution but does not directly cause personal injury or harm if ignored.



Warning!

To warn of dangerous situations that, if ignored, could cause injury or damage to the instrument.



Forbidden!

To signal the prohibition of an operation.



Observe the instructions!

To indicate that the instructions for use must be observed.

1.2 Safety information



Observe the instructions!

Read all safety instructions and directions.

- Failure to follow safety instructions and instructions may result in electric shock, fire and/or serious injury.
- Keep all safety directions and instructions for future use.



Notice!

- Upon receipt of the instrument, ensure the integrity of the delivery and, in case of non-conformity with what was ordered or damage to the instrument, promptly report the inconvenience to the carrier and the instrument supplier.
- Any adjustment, maintenance and repair of the equipment should be carried out only by trained service.
- Any contractual and extra-contractual liability of the Manufacturer for damage caused to persons, animals or property, from adjustment, maintenance errors and improper use is excluded.
- If you have any doubts regarding the condition and/or functionality of the instrument and attached parts, please contact Senseca Italy Srl.



Warning!

- During the first use of the instrument report, to the instrument supplier, any anomalies or malfunctions found.
- Use only original or Manufacturer-approved spare parts to avoid possible damage to the instrument.
- Do not remove any safety signs, stickers or labels from the instrument. Keep safety signs, stickers, or labels in good condition so that they can be read well.



Warning!

Explosion Hazard:

The device is not designed for use in potentially explosive environments. It should not be operated in the presence of flammable liquids or gases.

**Forbidden!**

It is forbidden to use the instrument improperly. In particular:

- Do not use the instrument in explosive environments or areas and in aggressive, corrosive atmospheres with oil-containing vapors.
- Do not use the instrument in the presence of flammable liquids or gases.
- Do not allow liquids to penetrate inside the instrument.
- Avoid condensation on the membrane, as it substantially alters its acoustic response, leads to corrosive phenomena and contributes to the formation of residues that are difficult to remove. In case of exposure of the microphone chain to weather, use outdoor protection systems.
- Avoid even minor impacts to the microphone capsule.
- Do not expose the instrument to strong vibration.

**Forbidden!**

It is forbidden to make changes and/or attempts to repair the instrument. In particular:

- Making changes, causes the instrument's Declaration of Conformity to lapse.
- For damage resulting from improper use, the user is solely responsible. Any repairs must be carried out by a qualified technician.

**Forbidden!**

- Children and persons with reduced abilities or lack of specific experience and knowledge are prohibited from using the instrument unless they are assisted by qualified personnel responsible for their safety.
- It is forbidden for children to play with the instrument.
- It is forbidden to disperse packaging material into the environment and leave it within the reach of children as it can be a potential source of danger. It must therefore be disposed of in accordance with current legislation.

2 Compliance and directives

Acoustic Directives

The product meets the following class 1 specifications.

Sound Level Meter:

- IEC 61672-1 (2013) class 1
- IEC 60651 (1979) plus amendment 1 (1993-02) and amendment 2 (2000-10), type 1
- IEC 60804 (2000-10) type 1
- ANSI S1.4-1983 plus ANSI S1.4A-1985 amendment type 1 (sound level meter)
- ANSI/ASA S1.4-2014 class 1
- ANSI S1.43-1997 type 1

Octave band and fractional octave filters:

- IEC 61260-1 (2014)
- ANSI/ASA S1.11-2014 Part 1

Homologation in accordance with IEC 61672-1 (2013) and IEC 61260 (2014) is pending.

IEEE 802.11 (Wi-Fi) certifications:

XPT80X sound level meters contain IEEE 802.11b/g/n certified RF module.

FCC ID: QQQWGM160P IC
ID: 5123A-
WGM160P
KC: R-C-BGT-
WGM160P TELEC: [R] 005-
102265



FCC and IC notices

Notice: This device complies with Part 15 -15.247(a2) and 15.247(b) and 15.249 of the FCC Rules and with Industry Canada (IC) licence-exempt RSS standard(s). Operation is subject to the following two conditions: (1) this device may not cause harmful interference, and (2) this device must accept any interference received, including interference that may cause undesired operation.

Notice: This equipment has been tested and found to comply with the limits for Class B digital device, pursuant to part 15 of the FCC Rules. These limits are designed to provide reasonable protection against harmful interference in a residential installation. This equipment generates, uses and radiates radio frequency energy, and, if not installed and used in accordance with the instructions, may cause harmful interference to radio communications. However, there is no guarantee that interference will not occur in a particular installation. If this equipment does cause harmful interference to radio or television reception, which can be determined by turning the equipment off and on, the user is encouraged to try to correct the interference by one or more of the following measures:

- Reorient or relocate the receiving antenna.
- Increase the separation between the equipment and receiver.
- Connect the equipment into an outlet on a circuit different from that to which the receiver is connected.
- Consult the dealer or an experienced radio/TV technician for help.

Notice: To satisfy FCC/IC RF exposure requirements for mobile and base station transmission devices, a separation distance of 20 cm or more should be maintained between the antenna of this device and persons during operation. To ensure compliance, operation at closer than this distance is not recommended. The antenna(s) used for this transmitter must not be co-located or operating in conjunction with any other antenna or transmitter.

Notice: Under Industry Canada regulations, this radio transmitter may only operate using an antenna of a type and maximum (or lesser) gain approved for the transmitter by Industry Canada. To reduce potential radio interference to other users, the antenna type and its gain should be so chosen that the equivalent isotropically radiated power (e.i.r.p.) is not more than that necessary for successful communication.

3 Identification

3.1 Product identification

- The serial number is printed on the label on the back panel.
- The microphone model and serial numbers are engraved on the outside of the microphone.
- The preamplifier model and serial numbers are engraved on the outside surface of the preamplifier.

Information regarding product identification can be found by accessing the page **SETTINGS > INSTRUMENT > IDENTIFICATION**.

3.2 Part numbers of main components and accessories

The following are the codes of the main components and accessories mentioned in the manual and related to the use of the XPT800 model.

| Code | Description |
|----------|--|
| XPT800 | Sound Level Meter |
| MP800 | Single range microphone preamplifier |
| MC800 | Precision microphone |
| WS90 | 90 mm Windscreen |
| WSO | Outdoor microphone protection |
| WSO-C | Outdoor microphone protection with built-in acoustic calibration system controlled by XPT800 |
| NS-ENS | Data processing software module |
| NS-SIS | Data processing software module |
| NS1 | Data processing software module |
| CPL-4.5 | 5 m microphone extension cable |
| CPL-4.10 | 10 m microphone extension cable |
| HD2020 | Class 1 acoustic calibrator, 94-114 dB. Frequency 1 kHz |

Firmware and hardware options are covered in the section “**5.3 Options and accessories**” on page 32.

3.3 Explanation of product code

| Code | Description |
|--------|--|
| XPT800 | <ul style="list-style-type: none"> • XPT: indicates the product line • 1st number: Leading Group (8=Sound & Vibration) • 2nd number: Subunit (0=Sound Pressure Levels) • 3rd number: level of functionality (0= higher level) <p>Any other numbers separated by a space may be present and follow the three-number code to indicate additional product features (e.g., number of channels or other information)</p> |

As for option codes these are preceded by a letter F if it is a firmware option or letter H if it is a Hardware option. They are always preceded by the code for the instrument to which they refer e.g. **XPT800-OF1E** refers to an option of the **XPT800** model, Firmware Option.

4 Description of the instrument

XPT800 is a class 1 sound level meter-spectrum analyzer.

It is based on a scalable platform that can be adapted to the growing needs of acoustic professionals. The needs for accuracy, high performance, and ease of use have been met through the use of the latest technology and careful consideration of suggestions from experts in the field. Top quality and performance to provide the acoustics specialist with a comprehensive and reliable tool for all major applications in the field, from environmental noise and building acoustics to risk assessment in work environments and laboratory and industrial product analysis.

4.1 Basic features

XPT800 performs the following basic operations:

- Sound measurement: stop, pause and resume measurement of instantaneous and integrated parameters.
- Fine-tune the measurement using a precision acoustic calibrator and archive the calibration history.
- Back-erase: upon operator command, backwards erases for a selectable time interval, data of unwanted sound events, excluding them from calculations of integrated values shown on display.
- Reset: resets, upon operator command, the integrated values shown on the display.
- Time recorder for single event metrics Lmax, Lmin, Lpeak-(max).
- Displays broadband and spectral sound values on a color screen.
- Displays real-time and stored data while a measurement is in progress.
- Allows you to freely select and change, even with measurement in progress, the displayed measurement parameters independently of the stored measurement parameters.
- Displays data in numerical and graphical form.
- Record audio signal with manual control or by automatic level trigger.
- Simultaneously records the time instant of measurement samples and sound events.
- Perform statistical analysis of broadband or spectral parameters.
- Use of manual or automatic markers to annotate portions of time tracks referable to specific sound events.
- Enter voice annotations related to the measurement.
- Continuous data storage on both internal and external high-capacity storage media.
- Connecting to a network through Wi-Fi, Ethernet, GSM devices.
- Diagnosis of proper hardware operation.
- Firmware update.
- Synchronizes the watch with PC, or Network Time Protocol (NTP).
- Create multiple custom configurations using APPLICATIONS.
- View data in the measurement archive.
- Mass storage to be used eMMC, USB stick.
- Recharges internal high-capacity batteries.
- Allows the use of alternative microphone chains to the standard chain and is compatible with both 200V-polarized and pre-polarized microphones.
- Handles preamplifiers equipped with internal heater for outdoor uses.
- Allows outdoor measurements using specific outdoor protection accessories.

Note: features may be related to specific firmware and hardware functions.



Info

For the complete list of operations that XPT800 can perform, see the section “**10 Advanced functions**” on page 80.

4.2 Possible applications

XPT800 is suitable for the following applications:

- Assessment of environmental noise levels (DM 16/03/98, ISO1996).
- Noise monitoring with sound event capture and analysis function.
- Spectral analysis for octave bands and third octave bands.
- Complete statistical analysis with calculation of all percentiles from L0.1 to L99.9.
- Measurements in workplace environment (ISO9612).
- Soundproofing and noise remediation.
- Manufacturing quality control.
- Measurement of machine noise.
- Building Acoustics (ISO16283).
- Speech intelligibility.
- Noise criteria

Note: Some features are expected but may not be available immediately but only successively after the product is released to the market. Please contact the Senseca Italy Srl sales office for more information.

XPT800 can be supplemented with additional options to extend its scope when needed; firmware can be upgraded directly by the user.



Info

For the complete list of available additional options, see the chapter “**5.3 Options and accessories**” on page 32.

4.3 Main features

- Large 4.3" color touch screen display.
- Memory: internal 4GB on eMMC and external USB-C stick.
- Ergonomic design for one-hand operation.
- Rugged body design for use in harsh environments.
- User interface: intuitive user interaction using smartphone-like gestures; ability to manage functionality even using the 3-button keyboard.
- Wireless connectivity: data transfer and remote control of the instrument.
- Internal interfaces: Wi-Fi, 4G, LAN, USB-C, RS232/485.
- Long-lasting battery life: internal rechargeable battery allows more than 30h of measurement time.
- “**Noise Studio Web storage**” (<https://noise-studio.senseca.com/>) web application: recorded data storage functions.
- **NS-ENS “Environmental Noise Studio”** desktop application: analysis of noise measurements and intelligent reporting tools for increased productivity.
- **NS-SIS “Sound Insulation Studio”** desktop application: analysis of passive acoustic requirements of buildings.

**Info**

For the complete list of features of the XPT800 instrument, please refer to the section **“18 Appendix A – Technical Specifications”** on page 157.

4.4 Performance characteristics

- Interchangeable microphone chains with automatic identification (digital sensor interface).
- Accuracy: class 1 according to IEC61672:2013.
- Single measurement interval: 20-140.
- Dynamic range: higher than 125 dB.
- Frequency weightings A, B, C, Z.
- Linear, exponential and moving averages.
- Simultaneous time constants Fast, Slow, Pulse, Peak.
- Audio recording: manual or automatic up to 32bit - 48KHz.
- Spectral analysis: real time 1/1 - 1/3 oct.; interval 6.3 Hz-20 kHz (IEC 61260).
- Statistical analysis: Ln broadband and 1/3 oct. band levels.
- Automatic detectors of tonal and impulsive characteristics of sound.

4.5 Instrument hardware overview

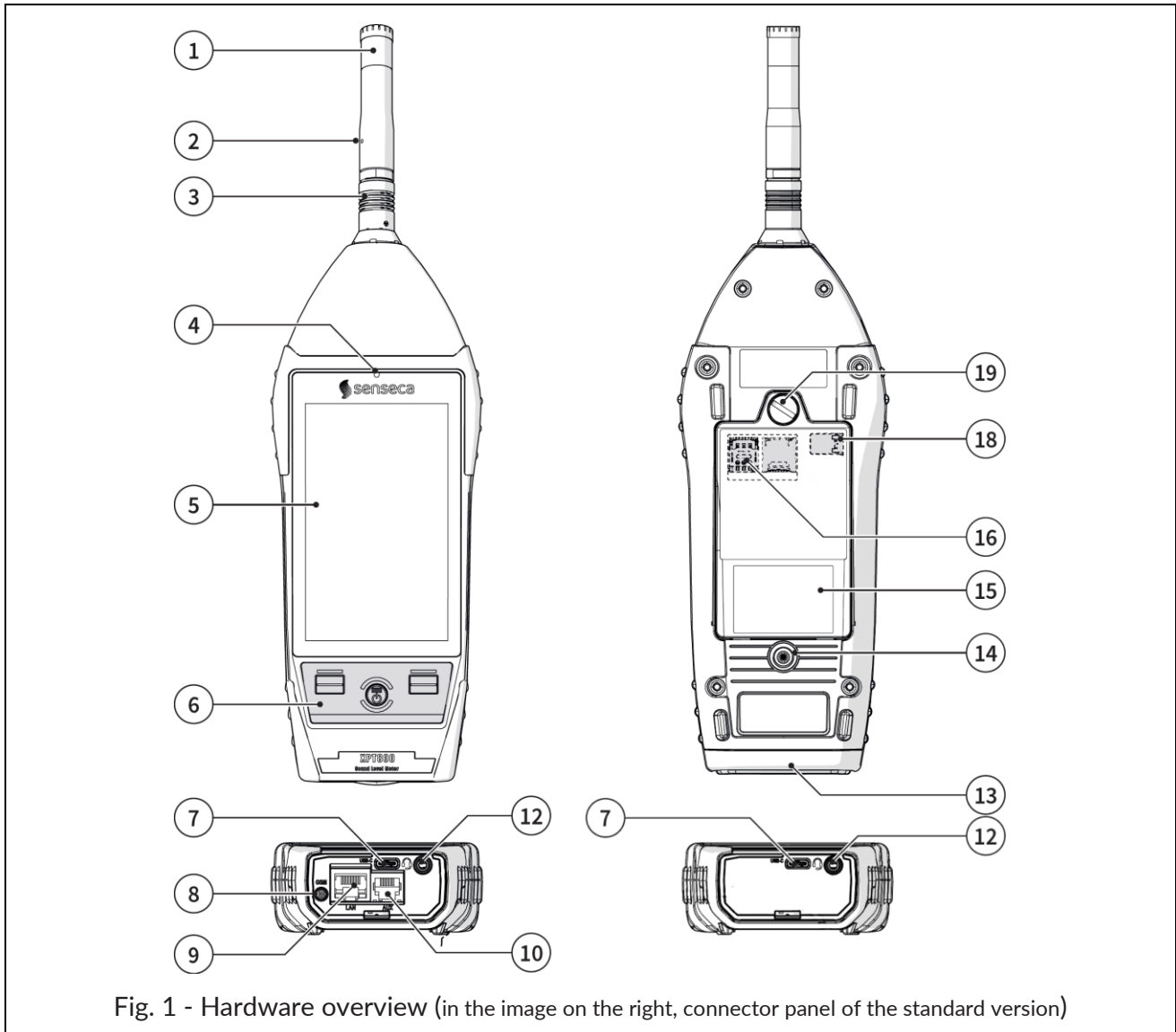

Fig. 1 - Hardware overview (in the image on the right, connector panel of the standard version)

- | | |
|---|---|
| <ul style="list-style-type: none"> 1 Microphone capsule 2 Preamplifier 3 Push & pull connector 4 Light sensor 5 Display 6 Keyboard 7 USB-C 8 GSM antenna connector (opt. OH3M) 9 LAN socket (opt. OH3A): RJ45 type connector 10 AUX connector (opt.OH3A): RJ12-type connector, for connection to external devices, e.g., a weather controller | <ul style="list-style-type: none"> 12 Connector for audio output / filtered AC output / trigger I/O: Ø 3.5 mm jack socket 13 Rubber protection for connectors 14 1/4" threaded hole for fixing stand 15 Battery compartment 16 SIM slot 18 Battery connection 19 Battery compartment opening/closing screw |
|---|---|

4.6 Description of main components

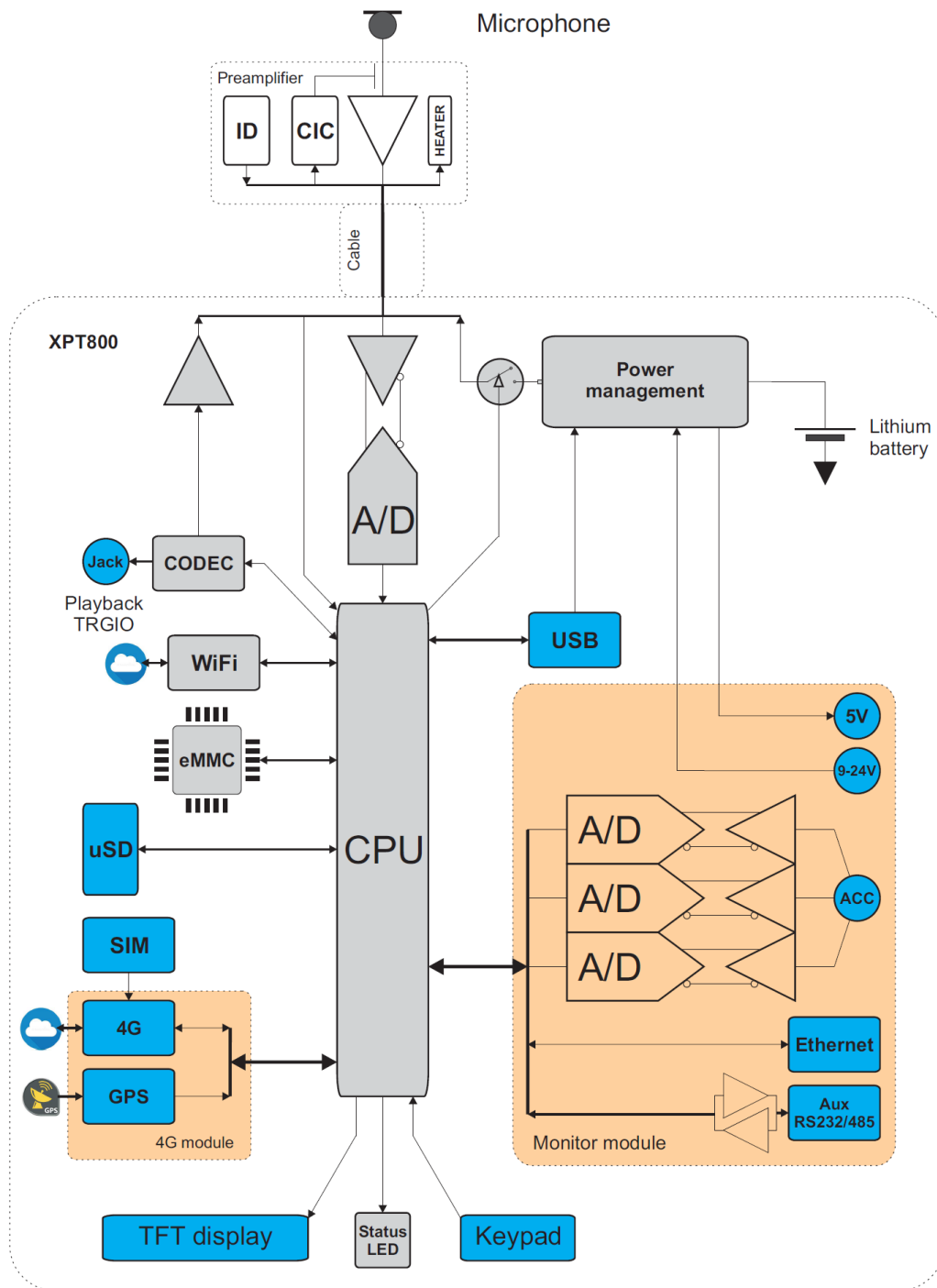

Fig. 2 - Block diagram

4.6.1 Microphone

The MC800 microphone supplied is of the pre-polarized condenser type, with 1/2" standard diameter and has a nominal sensitivity of 50 mV/Pa. With this microphone, the free-field frequency response is flat over the entire audio range, and the maximum measurable sound level of the XPT800 is 140 dB. The MC800 microphone meets the requirements of the international standard IEC 61094-4 for type WS2F. Optionally, other microphone types can be mounted.

For more details regarding the technical specifications of the microphones that can be combined with the **XPT800** sound level meter, please consult the relevant manuals or contact the Manufacturer.

4.6.2 Preamplifier

The **MP800** preamplifier performs the task of amplifying the weak signal provided by the microphone. The peculiar dynamic performance combined with low noise enables the detection of both very low and high level sound signals using a single measurement range. The **MP800** preamplifier is also equipped with a CTC (Capacitive Transducer Calibration) calibration device, which allows the drifts of the entire measurement chain, including the microphone, to be kept under control by means of a charge-sharing scheme.

Available models are listed in chapters “**5.2 Standard configuration**” on page **30** and “**5.3 Options and accessories**” on page **32**.

Heater

The **MP800** preamplifier is equipped with an internal heater, which can be activated from the GUI. Use of the heater is recommended to reduce condensation on transduction chain components in outdoor uses with high humidity levels and low temperatures.

Automatic detection

A chip inside the preamplifier stores certain information about the transduction chain (e.g., the preamplifier serial number) that is automatically detected by the **XPT800** sound level meter, allowing the user to use different transduction chains without the need for setting operations. Automatic identification is at startup.

4.6.3 Instrument

The signal from the preamplifier reaches the input of the A/D converter. The analog signal is converted into numerical form by the A/D. The exceptional resolution of the converter, which extends over a range of more than 140 dB, allows high accuracy to be maintained over a single measurement range of about 125 dB where digitization error is negligible. In the DSP, levels with broadband frequency weightings (A, B, C, and Z) and levels with both octave and third-octave constant percentage bandwidth weightings are calculated in parallel. Peak levels are also calculated. The levels calculated by the DSP are transmitted to the microprocessor for further processing, display and storage.

The microprocessor supervises all instrument processes: management of the electrical calibrator, memory, TFT touch display, keyboard, network and communication devices (LAN, Wi-Fi, 4G), codec, and interfaces (RS232C and USB).

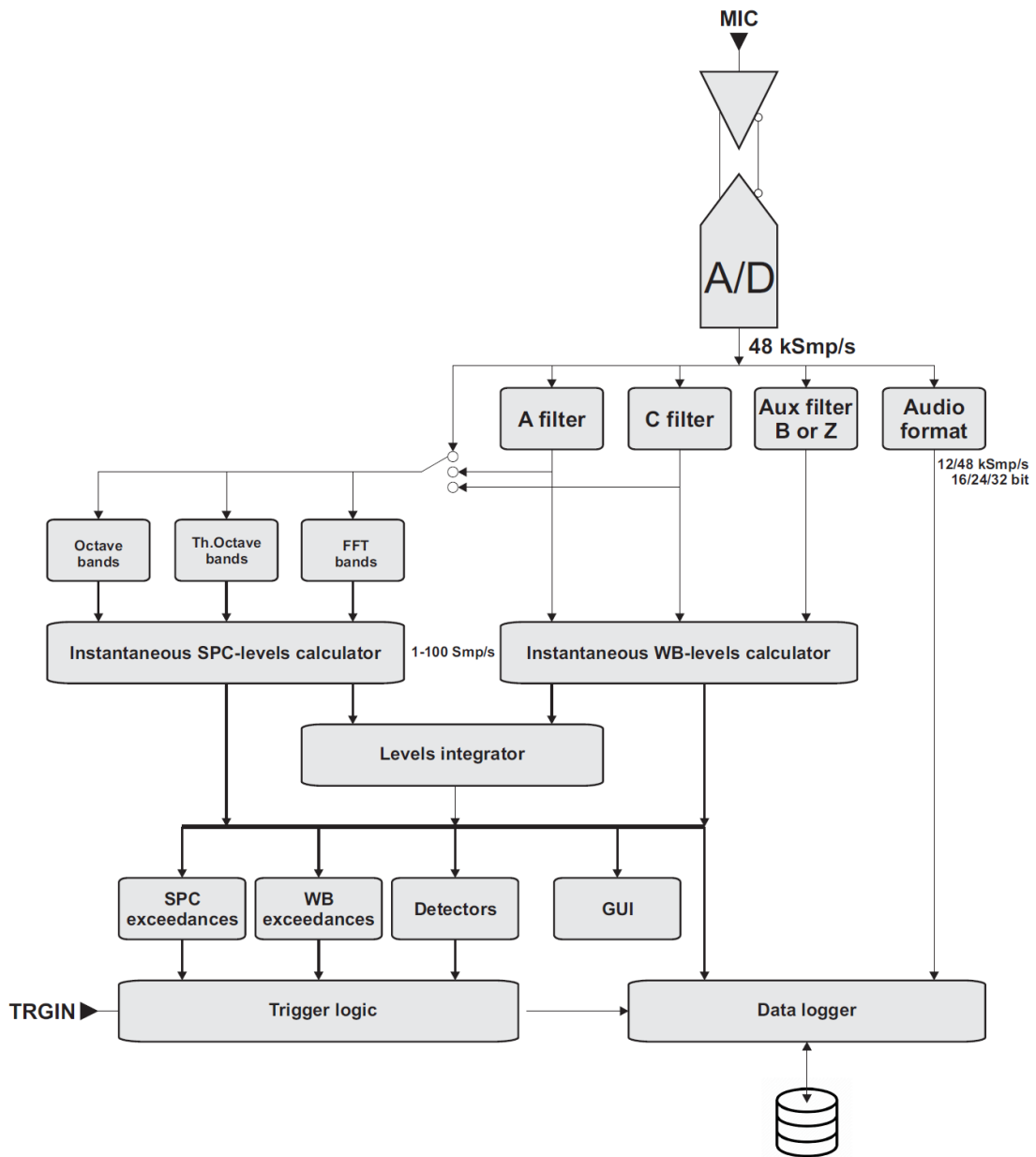

Fig. 3 - Analysis process

4.6.4 Outdoor microphone unit (optional)



Info

For more information, see the outdoor microphone unit manual provided with the unit.

The **WSO** microphone unit is suitable for prolonged time surveys in outdoor environments, including unattended fixed locations. The unit is adequately protected from rain and wind, and the heated pre-amplifier provides stability of acoustic parameters over time and allows surveys in a wide range of environmental conditions.

The preamplifier of **Senseca** sound level meters, coupled with the outdoor microphone unit, is equipped with a circuit for electrical calibration of the preamplifier-microphone capsule chain, which uses a charge-sharing technique.

The unit free-field frequency response meets class 1 specifications according to IEC 61672 (and IEC60651).

The **WSO** microphone unit must always be placed vertically to allow the rain shield to perform its function and can be used to detect both airborne and ground-borne noise. **Senseca** sound level meters make spectral corrections to measurements to ensure class 1 tolerances according to IEC61672 in every situation.

The easy disassembly and reassembly of the unit allow periodic verification of electroacoustic characteristics to be carried out in the same way as with a standard measuring microphone, using a standard ½" microphone calibrator.

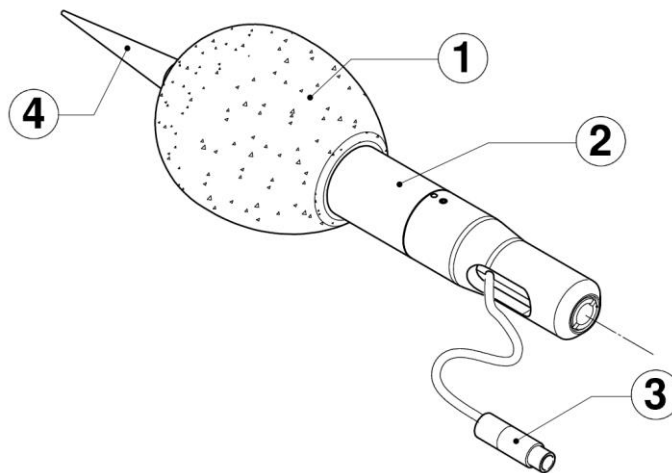

Fig. 4 - WSO outdoor microphone unit

- | | | | |
|---|-------------------------|---|----------------------|
| 1 | Windscreen | 3 | Microphone connector |
| 2 | Stainless steel support | 4 | Bird spike |

Note: For more details on using the outdoor unit, see chapters “[5.4.3 Outdoor microphone unit](#)” on page 38, “[5.4.4 Connect the outdoor microphone unit to the sound level meter](#)” on page 39 and “[9.1 Calibration](#)” on page 66.

4.7 Display

XPT800 is equipped with a color backlit TFT touchscreen with sunlight adaptability. For the full list of display features, see the section “[18 Appendix A – Appendix A – Technical Specifications](#)” on page 157.

The interface of the XPT800 is organized into status and control bars, and menus, the latter further organized into panels that can be accessed using navigation icons/keys.

When XPT800 is turned on, the instrument displays the Home page, containing elements common to most screens.

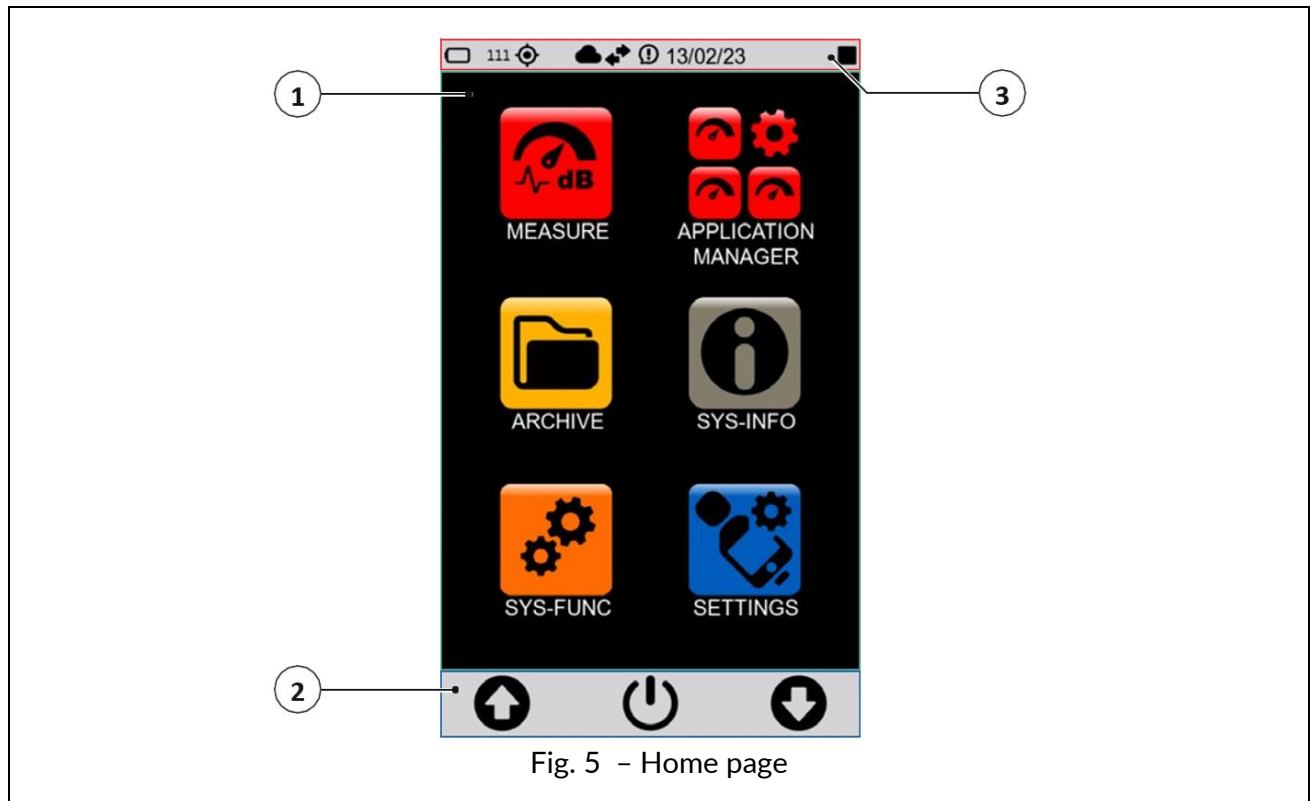

- 1 Home Page (Icon Menu)
- 2 Control bar
- 3 Status bar



Info

You can adjust some display settings, such as brightness and auto power off: see the section “[7 Settings and Adjustments](#)” on page 48.

4.7.1 Icon menu

The main screen of the instrument is called ICON MENU and is the access screen for the main features of the instrument represented by icons.

The icon has 2 states:

- inactive: the application is currently unavailable and is represented in shaded color; touch or keyboard have no effect.
- active: the application is available for execution and is represented normally; touch or keyboard runs the application.







The icon menu can be accessed, even during measurements, by holding down the center icon (MENU) on the control bar for a few seconds.



Fig. 6 – Icon menu

The basic applications of the instrument are described in the following table.

Table 1 – Icon menu

| Action | Icon | Description |
|---------------------|---|--|
| MEASUREMENT |  | Allows direct access to the measurement panel based on the settings of a setup of the user's choice |
| APPLICATION MANAGER |  | Allows access to panel for selection and management of custom measurement apps |
| ARCHIVE |  | Allows access to the panel for managing stored measurements |
| SYS-INFO |  | Allows access to the system information and monitor menus |
| SYS-FUNC |  | Allows access to system app menus |
| SETTINGS |  | Allows setting the working parameters of the instrument. Allows setting of all measurement parameters and control of all hardware and computational functions of the instrument. Frequently used parameters can also be accessed directly from the measurement screen. |

4.7.2 Status Bar

The status bar describes through icons the status of the instrument, power, connectivity and measurement status. It also provides access to the activation keys.

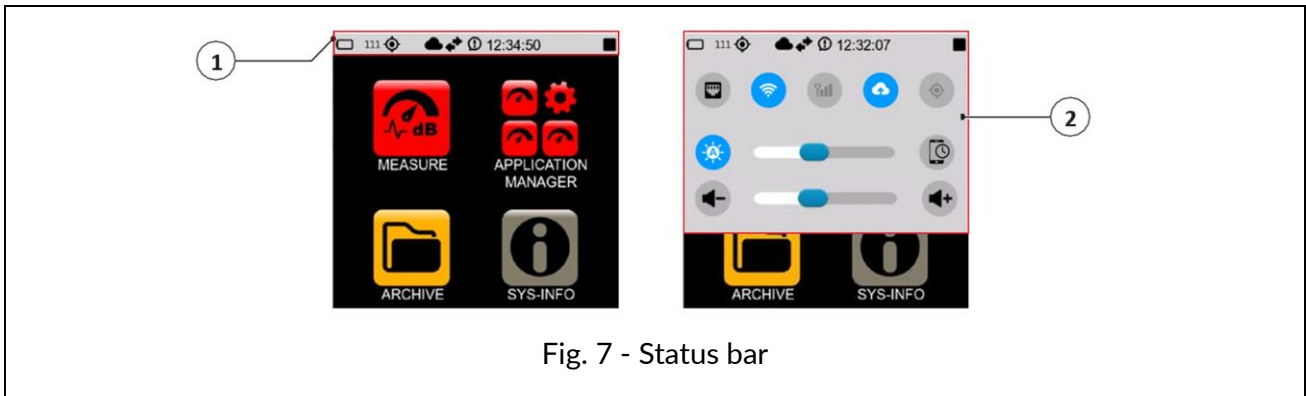

Fig. 7 - Status bar

- 1 **Status icons:** indicate the mode and operation status of the instrument
- 2 **Activation icons:** activated with blue colour, deactivated with gray colour



Status icons











| Icon | Description | Icon | Description | Icon | Description |
|------|--|------|---|------|---|
| | Writing to eMMC | | Writing to USB key | | |
| | Access to "Cloud Storage service" occurred | | Cloud active but access to "Cloud storage service" not occurred | | Access to "Cloud Manager service" occurred |
| | Access to "Cloud Monitor service" occurred | | Synchronization queue (black arrows) | | Synchronization active (green arrows) |
| | Measurement with recording | | Pause | | Stop |
| | Measurement | | Audio recording | | Notification |
| | Indication of overload in progress | | Overload memory | | Under range |
| | LAN | | Wi-Fi | | Modem |
| | | | Battery | 99% | % available memory of the memory support used |
| | Voice comment | | Scheduled log start | | |

Activation keys

With functionality available, the activation buttons appear in gray color with the symbol in white color. At the time the functionality is activated, the icon appears in blue color. In case the functionality is not available (e.g. 4G hardware not present), the corresponding icon appears present but inactive, with the symbol in gray color.

Example of activating/deactivating modem functionality:

-  Functionality available
-  Functionality NOT available
-  Functionality activated

| Icon | Description | Icon | Description | Icon | Description |
|---|------------------------|---|---|---|---------------------------------|
|  | Wi-Fi activated |  | Cloud transfer activated ⁽¹⁾ | | |
|  | Display shut-off timer |  | Modem activated |  | Automatic brightness adjustment |
|  | Ethernet activated |  | Increase volume |  | Decrease volume |
|  | Adjusting slider |  | Screenshot |  | Energy Saving mode |

(1) The key turns on/off the parameter Log synchronization. If active and if there are files available to synchronize, the status icon  will indicate synchronization.







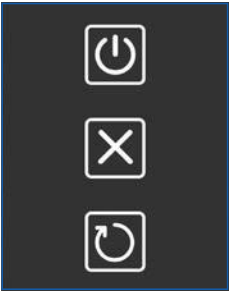

4.7.3 Control Bar

It allows the user context control and access to related menus. The bar contains three symbols possibly accompanied or replaced by text to indicate three possible actions that the user can perform either by the corresponding key or by touch. A long press of the ENTER key takes the user back to the icon menu.

The content of the bar depends on the context, level, and related status:

- **CONTEXT:** refers to the running application, e.g., Measure, Archive, Sys-info, etc.
- **LEVEL:** in the specific context refers to a specific action.
- **STATUS:** follows the progress of a specific action.

Table 2 - Control bar icons

| Icon | Description |
|---|--|
|  | Icon menu control <ul style="list-style-type: none"> • Up/down arrows: icon selection • ON/OFF icon: access to the OFF panel (press 3 seconds) |
|  | OFF panel Press the ON/OFF button for 3 seconds to activate it. <ul style="list-style-type: none"> • Upper icon: turns off the instrument • Middle icon: cancels the operation and closes the panel OFF • Lower icon: restarts the instrument |
|  | Measurement control <ul style="list-style-type: none"> • Left icon: start measurement without recording • Right icon: start measurement with recording (Log) • Central icon (MENU): access to the context menu |
|  | With measurement started: <ul style="list-style-type: none"> • Left icon: pause • Right icon: stop • Central icon (MENU): access to the context menu |
|  | With measurement started and pause button pressed: <ul style="list-style-type: none"> • Left icon: pause release • Right icon: reset (held values and overload indication) • Central icon: back-erase |
|  | With recording (Log) started: <ul style="list-style-type: none"> • Left icon: manual audio recording • Right icon: stop recording • Central icon (MENU): access to the context menu |
|  | Navigation/function management <ul style="list-style-type: none"> • Arrows (UP/DOWN): allow you to navigate through the available functions • Central icon (OK): enter the menu |
|  | <ul style="list-style-type: none"> • Middle icon (EXIT): exit the menu |
|  | <ul style="list-style-type: none"> • Central icon (FILTER): allows you to set search filters |

4.7.4 Context menu

Once the measurement panel (MEASURE) has been accessed, the context menu is available in the control bar. The various functions also available during measurement and recording are shown below.

Table 3 - Context menu

| Icon | Description |
|---|---|
|  | <p>CLOSE Closes the context menu</p> <p>EDIT APP Set the recording parameters, see “9.4 Set acoustic parameters to be stored” on page 69.</p> <p>EDIT VIEW Select the parameters visible during the measurement, see “9.3 Select acoustic parameters to be displayed” on page 68.</p> <p>SEL. VIEW Change the display mode, see “8 Viewing modes” on page 53.</p> <p>MARKERS (active only during a measurement) Set markers, see “9.11 Manually add markers to the measurement” on page 79.</p> <p>SAVE APP Stores current settings</p> |

4.8 Navigation and selection

To navigate within the functions of the instrument, press on the desired item or icon on the touchscreen display or press on the navigation icons on the control bar.

See the chapter “[4.7 Display](#)” on page [23](#) for the complete list of icons in the display and their function.



Info

To quickly exit any screen and return directly to the home page, simply press and hold down for as long as necessary the center icon of the control bar, whatever it is.

4.9 Keyboard

The keyboard has a waterproof backlit membrane. There are two function keys with white LED backlighting and an ON/OFF/ENTER key with custom-shaped RGB backlighting.

The keys on the keypad have the same functions as the corresponding icon on the control bar, for a detailed explanation of the functions see the section “4.7.3 Control Bar” on page 27.

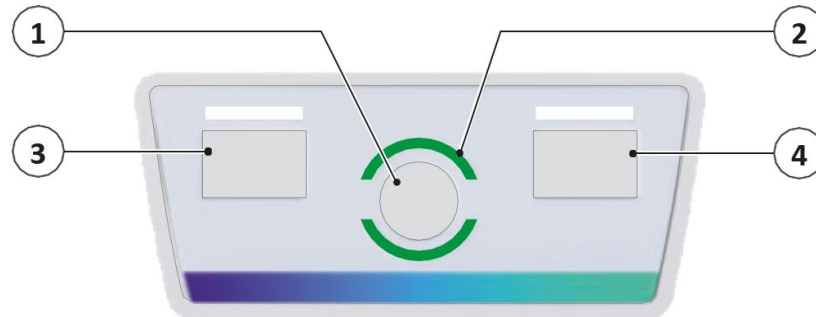

Fig. 8 - Keyboard overview

- | | |
|---|--|
| <p>1 ON/OFF/ENTER key emulates the central icon of the control bar ENTER function ON/OFF function: pressed briefly turns the instrument on</p> | <p>2 RGB status LED 3 LEFT key (White LED): emulates the left icon of the control bar 4 RIGHT key (White LED): emulates the right icon of the control bar</p> |
|---|--|



4.10 Entering text and numbers

XPT800 has a virtual keyboard that is displayed when selecting a field in which text is to be entered.

The virtual keyboard allows entry of character strings such as letters and numbers.

The instrument also has a numeric keypad for entering both integer and floating-point numeric values.

The following is an example of text input.

- 1 Press in the text input field.
- 2 The virtual keyboard is displayed.
- 3 Press on the keys to enter the desired text.
- 4 Press  to confirm, press  to cancel the operation.



5 Pre-use checks and operations

5.1 Unpacking and inspection

- XPT800 is shipped in protective packaging.
- Immediately report any damage to the instrument packaging to the transporter and instrument supplier.
- Verify that the shipment contains all parts and accessories for the selected configuration, see chapter “**5.2 Standard configuration**” on page 30.
- Verify that all purchased options are active in SYS-INFO/ FIRMWARE/OPTIONS.
- Save the packaging for possible safe shipment to the service department.







Info

The quality level of our instruments is the result of continuous development of the instrument. This can lead to differences in the parts and accessories listed in the standard configuration and the parts that make up the instrument you have purchased. We recommend that you check with what you have ordered.

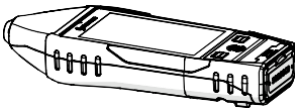
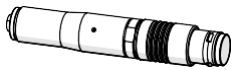
5.2 Standard configuration

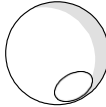
XPT800 is available as part of an integrated system or in a standard configuration. The following components are supplied with the standard configuration:

| Component | |
|--|---|
| XPT800 Sound Level Meter |  |
| MP800 preamplifier |  |
| MC800 microphone |  |
| WS90 windscreen |  |
| Standard semi-rigid transport case BAG-XPT <ul style="list-style-type: none"> • Document pocket • Preformed sponge for positioning sound level meter, wind shield, calibrator and accessories |  |
| Certificate of Conformity | |
| Free access to cloud storage space | |

The following hardware and firmware options are included with the standard configuration:

| Hardware options | Description | Code |
|------------------|--|------------|
| Basic | Sound level meter, carrying case, WS90 windscreen, USB-C cable, conformity certificate | XPT800 |
| OH1 | MC800 microphone (50mV/Pa) + MP800 preamplifier set | XPT800-OH1 |
| OH4 | Outdoor measurements: CIC management, preamplifier heater power supply | XPT800-OH4 |
| OH5 | Measurements with sound source controlled by the instrument (STI, Reverberation, etc.) | XPT800-OH5 |

| Firmware options | Description | Code |
|------------------|--|--------------|
| OF3 | Statistic Analyzer: <ul style="list-style-type: none"> • user Ln (wideband level) • Probability and cumulative probability distribution (wideband levels) | XPT800-OF3 |
| OF5S | Measurement data synchronization on NS-Storage cloud service (Push) <ul style="list-style-type: none"> • Manual • Automatic | XPT800-OF5S |
| OF8A | Event detector: <ul style="list-style-type: none"> • User programmable exceedances • User programmable third octave spectrum window acceptance (with OF1E options) • EVENT profile recording trigger logic • AUDIO recording trigger logic (with OF4 option) | XPT800-OF8A |
| OF8B | Fast data logging: <ul style="list-style-type: none"> • History profiles down to 10ms sampling interval | XPT800-OF8B |
| OF8C | Moving average calculations: <ul style="list-style-type: none"> • wideband levels • octave band levels (with OF1AE options) • third-octave band levels (with OF1E options) • wideband percentile levels | XPT800-OF8C |
| OF8D | Noise Assessment Period Levels: <ul style="list-style-type: none"> • Ldn, Lden, Lday, Levening, Lnight | XPT800-OF8D |
| OF13A | Datalogger: <ul style="list-style-type: none"> • HISTORY profiles from 100 ms to 1 s step • GLOBALS recording | XPT800-OF13A |
| OF13B | Advanced datalogger: <ul style="list-style-type: none"> • HISTORY profiles from 100 ms to 1 s step • REPORTS profiles from 10 s to 1 h step • EVENTS profiles • GLOBALS recording | XPT800-OF13B |
| OF15 | Extended dynamic range: <ul style="list-style-type: none"> • >35-bit measurement resolution • 0.01 dB resolution on 143 dB measurement range • 120 dB linearity range according to IEC 61672 | XPT800-OF15 |





5.3 Options and accessories

5.3.1 Hardware accessories

The table below contains only a few examples of the available hardware accessories. Additional components include, but are not limited to, microphones, preamplifiers, software, power supplies, tripods, calibrators, sensors, protective cases, adapters, and cables.

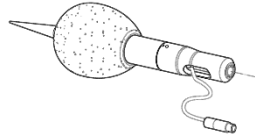
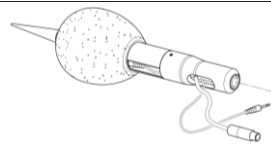
For a complete list of standard and system accessories, see website www.senseca.com.

The following components can be supplied in addition to the standard configuration:

| Component | |
|---|---|
| HD2020 acoustic calibrator cl.1 IEC 60942, 94/114 dB @1 kHz |  |
| WSO Outdoor microphone unit |  |
| WSO-C Outdoor microphone unit with built-in sound source |  |
| CPL-4.5 / CPL-4.10 Microphone extension cable (standard length 5m or 10m, other lengths available on request) |  |
| XPT800/SA Support to fix the preamplifier to the tripod (to be used with CPL-4xx cables) |  |
| Large rugged carrying case BAG8K <ul style="list-style-type: none"> • airtight seal • automatic pressurization valve • safety locks with push button • padlock predisposition • shoulder belt predisposition • lightweight and impact-resistant body • preformed sponge for positioning sound level meter, calibrator, windscreen and accessories |  465 x 355 x 145 mm |

5.3.2 Hardware options

| Hardware options | Description | Code |
|------------------|--|-------------|
| OH3A | Monitor module: <ul style="list-style-type: none"> • RS232/485 interface • external power supply 9 V-24 V • 9 V-24 V battery charging • 5 V 500 mA output for external accessories power supply • Ethernet connection | XPT800-OH3A |
| OH3H | Network module with 4G modem (needs OH3A) | XPT800-OH3H |

**Info**

Installation of hardware options is the responsibility of the Manufacturer, so you must return the instrument to perform the installation.

5.3.3 Firmware options

| Firmware options | Description | Code |
|------------------|---|--------------|
| OF1E | Spectrum analyzer: <ul style="list-style-type: none"> • IEC 61260 octave bands from 8 Hz to 16 kHz • IEC 61260 third-octave bands from 6.3 Hz to 20 kHz • Real time operation from 6.3 Hz to 20 kHz according to IEC 61260 • Latency equalized filters for transient analysis | XPT800-OF1E |
| OF1AE | Spectrum analyzer: <ul style="list-style-type: none"> • IEC 61260 octave bands from 8 Hz to 16 kHz • Real time operation from 8 Hz to 16 kHz according to IEC 61260 • Latency equalized filters for transient analysis | XPT800-OF1AE |
| OF2 | FFT Spectrum analyzer | XPT800-OF2 |
| OF3S | Advanced Statistic Analyzer (needs OF1E): <ul style="list-style-type: none"> • calculation of sliding percentile levels • measurement of 7 user selectable percentiles of third-octave band levels • probability and cumulative probability distribution of third octave band levels | XPT800-OF3S |
| OF4 | Audio recording (Manual, Automatic): <ul style="list-style-type: none"> • 16-bit, 24-bit or 32-bit resolution • 12 kSmp/s or 48 kSmp/s sampling rate • WAVE or ADPCM format | XPT800-OF4 |
| OF6 | STI calculation with STIPA method (needs OF1AE or OF1E options) | XPT800-OF6 |
| OF9 | Noise Ratings NC, RNC, NR, RC (needs OF1E or OF1AE) | XPT800-OF9 |
| OF11A | Automatic Detectors <ul style="list-style-type: none"> - Tonality detector ISO1996 (with OF1E option) - Impulsivity detector ISO1996 | XPT800-OF11A |
| OF11B | Automatic Detectors (DM16/03/98) <ul style="list-style-type: none"> - Tonality detector (with OF1E option) - Impulse detector | XPT800-OF11B |
| OF12 | Reverberation time calculation (T60) <ul style="list-style-type: none"> - Interrupted noise source - integrated impulse response | XPT800-OF12 |



Info

Firmware options are installable by activation code after purchase. Refer to the chapter [“13.4 Enabling or disabling instrument software options”](#) on page 149.

5.3.4 Software options

| Software options | Description | Code |
|------------------|--|----------|
| NS-Storage | NS-Storage cloud service: - Measurement data archive - Measurement data view: graphics, tables - Synchronization API - Limited storage space | Included |
| NS-ENS | Environmental Noise Studio: desktop software module for advanced environmental noise analysis. Compatible with Windows OS (min. Windows10) | NS-ENS |
| NS-SIS | Sound Insulation Studio: desktop software module for advanced building acoustics analysis. Compatible with Windows OS (min. Windows10) | NS-SIS |
| NS1 | Workers Protection Module: Analysis of the noise and vibrations exposure in the workplace (CH20 hardware key required) | NS1 |



Info

Software options are installable by activation code after purchase.

5.3.5 Hardware Upgrades

| Hardware options | Description | Code |
|------------------|--|---------------|
| U-OH3A | Monitor module: <ul style="list-style-type: none">• RS232/485 interface• external power supply 9 V-24 V• 9 V-24 V battery charging• 5 V 500 mA output for external accessories power supply• Ethernet connection | XPT800-U-OH3A |
| U-OH3H | Network module with 4G modem (needs OH3A) | XPT800-U-OH3H |

Note: The instrument has to be delivered to Senseca

5.4 Assembling and disassembling components

5.4.1 Microphone and preamplifier



Warning!

Observe the following instructions when assembling and disassembling the microphone and preamplifier:

- Connect to ground so that the device is not exposed to static shock.
- Clean from any dust or debris.



Forbidden!

During the assembly and disassembly of the microphone and preamplifier:

- Avoid even minor shocks: the microphone may be damaged.
- Never use excessive force or screw too hard.
- Do not remove the microphone grid cap and expose the diaphragm.
- Do not unscrew the microphone unless strictly necessary.
- Do not use glue to screw in the microphone.

To connect the microphone and preamplifier.:

The body of the preamplifier houses a single gold-plated stud with threading on the top edge, designed to fit the ½" microphone and a "push & pull" coupling for connection to the sound level meter.

- 1 Carefully place the bottom of the microphone over the top of the preamplifier and gently screw the assembly on. The body of the microphone should fit snugly against the body of the preamplifier.
- 2 Place the preamplifier in line with the sound level meter pins and with the red mark toward the front of the sound level meter. Insert the preamplifier firmly into the sound level meter until you hear a small click.

To disconnect the microphone and preamplifier.:

- 1 Gently grasp the microphone on the two etched lines and unscrew it.
- 2 Grasp the preamplifier firmly with one hand, with two fingers pull the ferrule outward until the preamplifier disconnects.

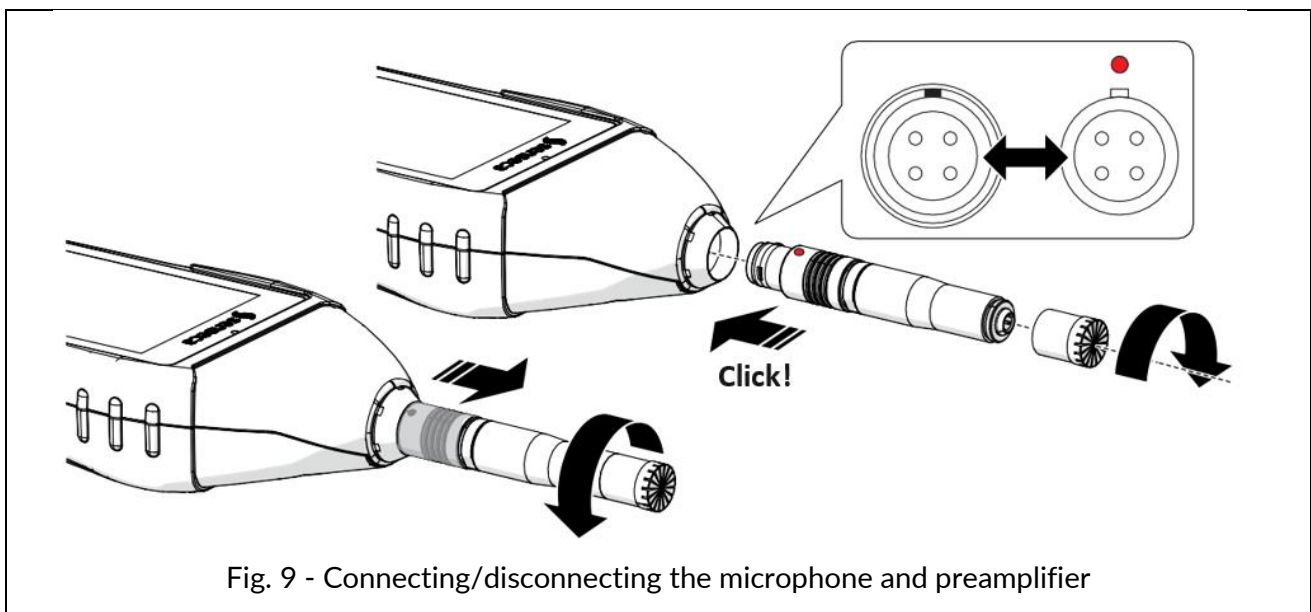

Fig. 9 - Connecting/disconnecting the microphone and preamplifier

5.4.2 Windscreen

When making outdoor measurements in windy weather or when making measurements on air conditioning equipment, wind noise or air movement against the microphone can generate measurement errors. Such effects can be reduced by using a wind protection bonnet.

To avoid possible measurement errors, use the windscreen on the microphone, especially when there is strong wind or substantial airflow generated by equipment.



Info

Since the wind shield can protect the microphone from accidental shocks, it is recommended to use it even during indoor measurements.

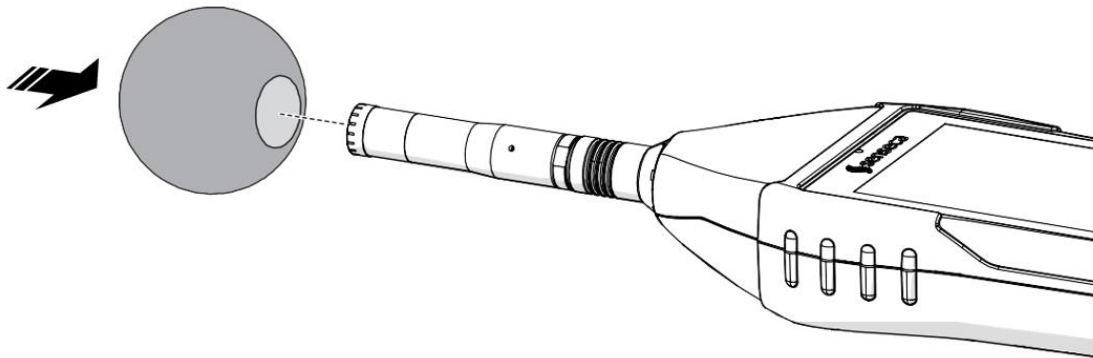

Fig. 10 - Assembly and disassembly of windscreen

5.4.3 Outdoor microphone unit

Disassembly of the Unit is necessary to perform, for example, calibration (partial disassembly only) or cleaning.



Info

- To pull out the top of the unit and perform calibration, follow steps 2 and 3.
- See the outdoor microphone unit manual for more information.

To completely disassemble the unit, you need to have a 2 mm hexagonal Allen wrench.

- 1 Unscrew the unit from the holder 1/2W or 1/4W, if any.
- 2 Using the Allen wrench, loosen the grub screw securing the top (A) of the protection.
- 3 Disconnect the upper part (A) of the guard from the lower part (B) by pulling it off the sensor (D); be careful not to damage the sensor.
- 4 To completely remove the sensor (D), disconnect it, via push-pull connector, from the extension cable (E) and pull the cable out by passing the connector through the hole (F).

To perform the assembly, proceed in the reverse way.

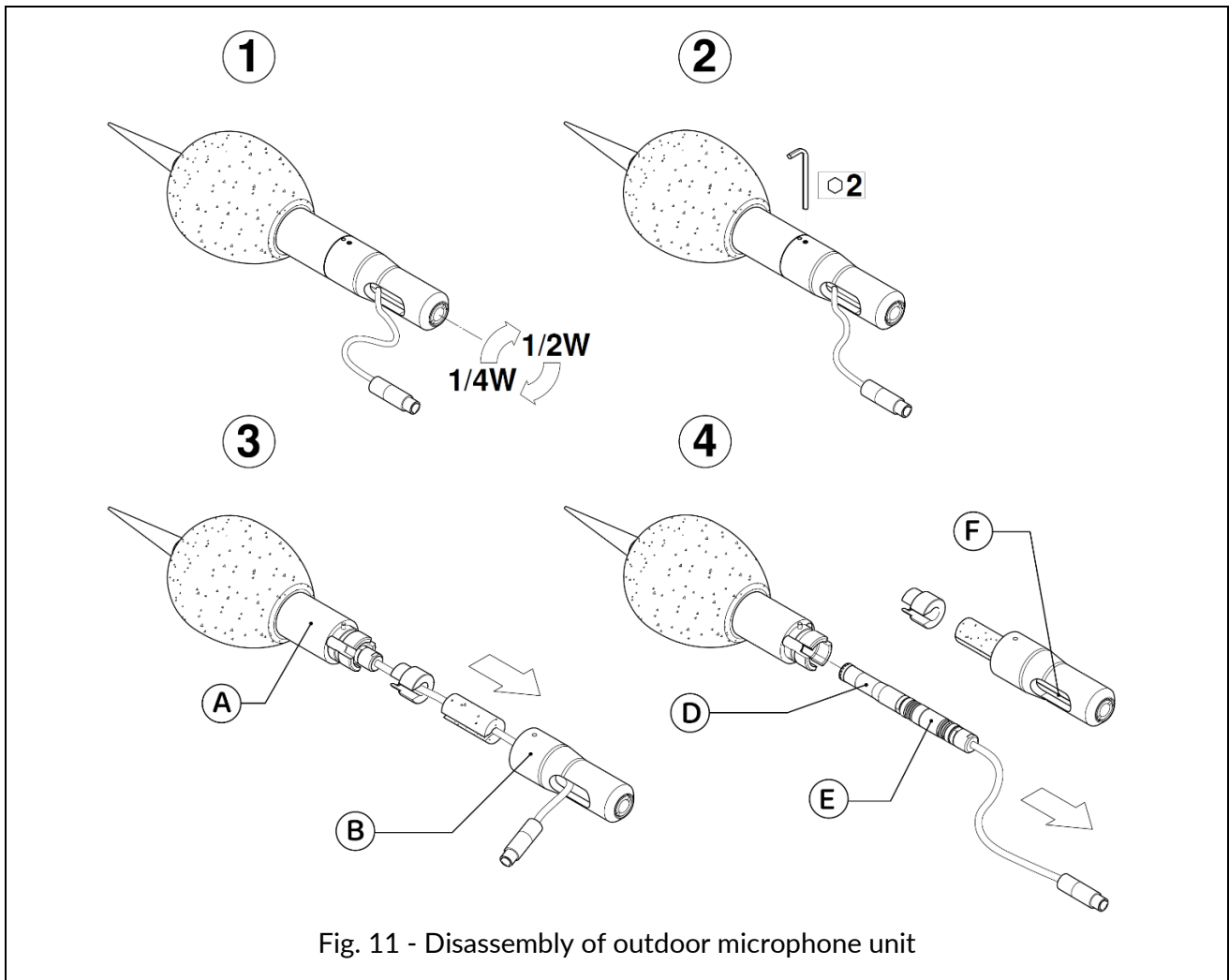

5.4.4 Connect the outdoor microphone unit to the sound level meter

After placing the outdoor microphone unit at the measurement site, it can be connected to the sound level meter.

- 1 Remove the microphone from the sound level meter, see section “5.4.1 Microphone and preamplifier” on page 37”.
- 2 Insert the connector of the outdoor microphone unit into the sound level meter until you hear a small click, pay attention to the orientation of the red pin.
- 3 If necessary, use the extension cable provided.

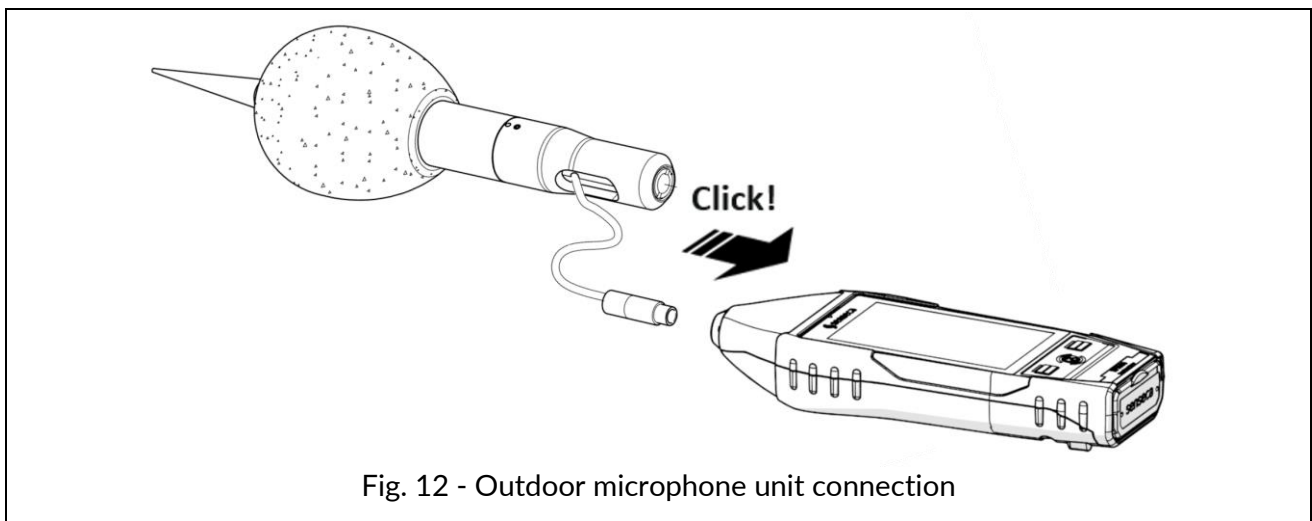

5.4.5 Mounting on a tripod

To minimize operator influence on measurements, or in the case of measurements taken over long periods, the instrument can be mounted on a standard camera tripod using the 1/4" threaded hole on the back of the instrument, see "[Fig. 1 - Hardware overview](#)" on page 18.

5.5 Battery power supply



Info

The XPT80X is delivered with the battery approximately 50% charged. Before use, fully charge the battery



Warning!

Safety Information

- To avoid electrostatic discharge, switch OFF the instrument to remove the battery
- Operating temperature: 0-45°C
- Avoid short-circuiting the battery contacts
- Avoid heating battery above +60°C
- Do not solder on battery
- Do not open the battery pack
- Dispose of the used battery according to regulations

5.5.1 Battery power use

The instrument is supplied with the battery, already inserted in the battery compartment and with unplugged connector. Please refer to the [5.5.3](#) on page 42 to make the correct connector connection.

The current battery voltage is displayed in the status bar, where there is a status icon with a battery symbol. Battery discharge is displayed as a progressive emptying of the symbol.

- When the remaining energy is less than about 15%, the battery status icon is empty (no notch).
- A protection system prevents the instrument from making measurements with insufficient charge levels and, if it is in measurement, performs the measurement stop automatically. If the battery level drops further to the minimum level necessary to ensure functionality, the instrument automatically shuts down.
- When the battery voltage drops below 3.1 V, the sound level meter is unable to take measurements. However, it is still possible to access the data in memory and perform data downloading. Stored data and configuration and calibration parameters are retained even when the power supply fails.

Battery charge indicator

The battery icon, found in the status bar, displays the charging status of the battery. When the instrument is charging or external power is being used, the background of the icon is orange.

| Icon | Description | Icon | Description |
|------|-------------|------|------------------|
| | 85% ÷ 100% | | 15% ÷ 35% |
| | 60% ÷ 85% | | 0% ÷ 15% |
| | 35% ÷ 60% | | Battery charging |

5.5.2 Charging the battery



Notice!

Use only a USB-C type cable paired with a standard cell phone power supply with the features listed below and suitable for mains power supply.

| Characteristics of the battery (supplied) | |
|---|--|
| Type | Rechargeable battery pack Li-Ion polymer |
| Protection | PCM circuit for battery cell protection, temperature protection |
| Capacity | 9000 mA (3.7 V) |
| Operating time | > 30h (wifi OFF) > 24h (wifi ON) |
| Charge time | 8-12 h depending on the charger used |
| Operating temperature | Charging 0...+45 °C, discharging -20...+60 °C |
| Battery life cycles | > 500 complete discharge and recharge cycles with 80% initial capacity remaining |
| Power supply (not supplied) | |
| Output | 5 Vdc / 2.1 Ah / 10.5 W |

When the instrument is connected to the charger and charging is in progress, the battery charge indicator on the status bar has **orange** icon background and the keypad status **LED is orange**. If connected to PC via USB, the **charging current is limited to max 500 mA**. If connected to battery charger, with instrument on and low power mode, charging current exceeds **1 Ah** recharging the batteries in less time; charging completion is indicated by led in the center key (led in **white color**).

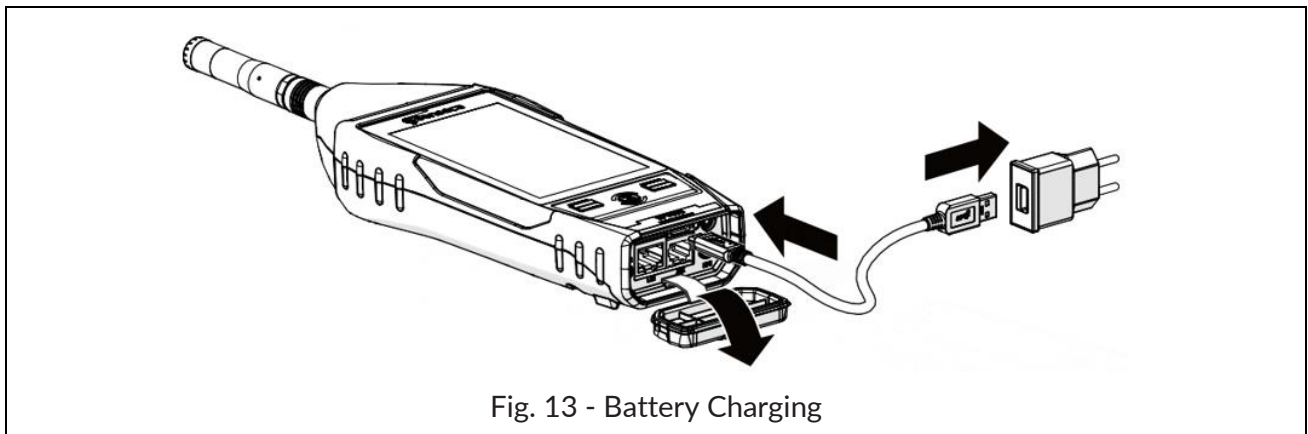

Fig. 13 - Battery Charging

- 1 Connect the USB-C cable to the power supply and USB-C connector on the instrument.
- 2 Plug the power supply into a compatible electrical outlet.
- 3 When 100% charge is reached (**white colored** keyboard status LED) remove the power supply and USB-C cable from the instrument.



Warning!

Do not leave the instrument on charge for longer than necessary, as soon as 100% charge is reached remove the power supply, this is to avoid overheating the battery and compromising battery life.

Management of charging when the instrument is switched off

To ensure faster and more effective charging, we recommend connecting the charger with the instrument switched off. In this mode, power consumption is minimised, allowing the battery to recharge faster and more efficiently.

In addition, charging with the instrument switched off contributes to:

- **Reduce charging time**, avoiding simultaneous power consumption.
- **Preserve battery life** by limiting partial charge cycles and overheating.
- **Improving charge stability**, enabling optimal energy distribution.

It is recommended, whenever possible, to switch off the device during charging for optimal battery performance.





Battery Charge Indicator

The battery charge indicator is only activated when the device is switched off and the charger is connected.

The charge level is indicated through four colour states:

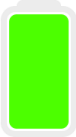
- **Red (<10%): Battery low.** Immediate recharging recommended.
- **Orange (>10%): Low battery level.** A recharge should be planned.
- **Yellow (>30%): Battery at medium level.** The device can function, but it is recommended to monitor the charge.
- **Green (>80%): Battery almost fully charged** and ready for optimal use.

The indicator provides a clear visual reference of the battery status only during the charging phase with the device switched off. To activate the indicator with the display off, press the centre key on the keypad.

| Battery charge status indicator when the instrument is switched off | | | |
|---|---|---|---|
|  |  |  |  |
| >80% | >30% | >10% | <10% |



Notice!

With a new battery, perform a few cycles of 100% charge and full discharge of the battery to enable proper charge management.

5.5.3 Battery insertion and replacement



Warning!

Before proceeding with battery insertion and/or replacement, make sure the instrument surface is dry and the instrument is turned off.

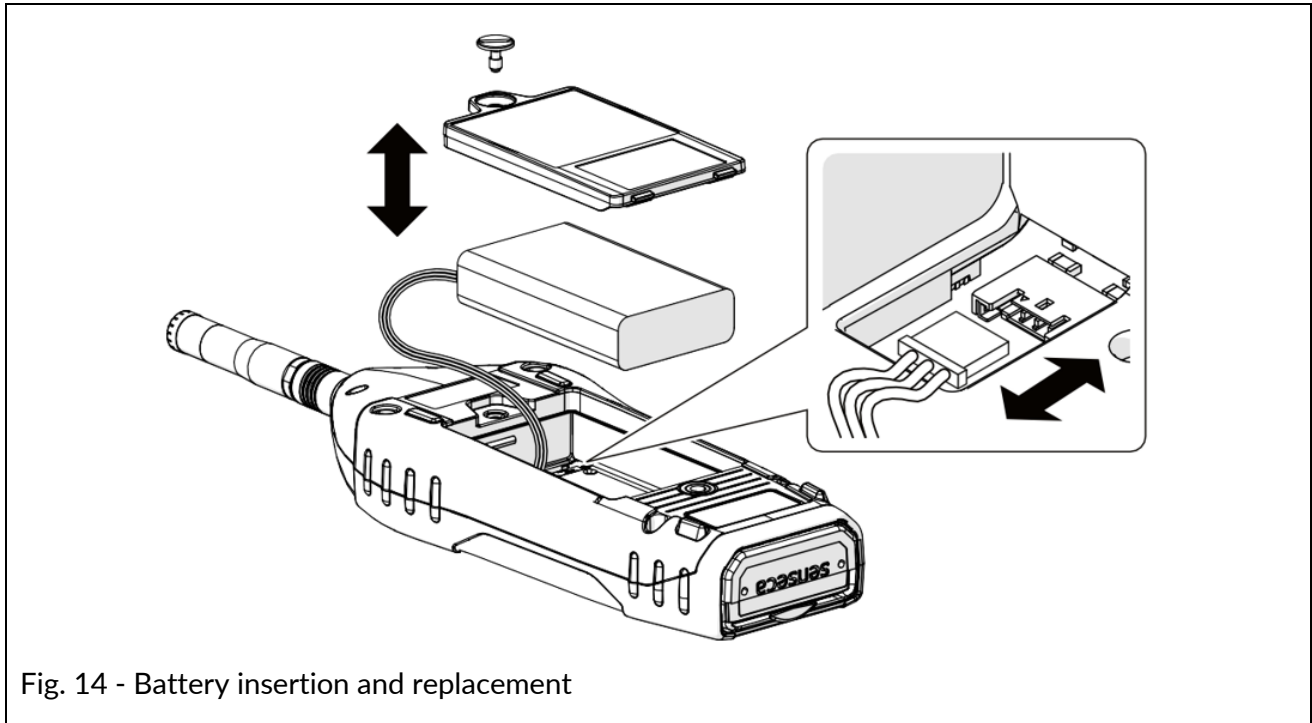

Fig. 14 - Battery insertion and replacement

- 1 Open the battery compartment at the back of the instrument by unscrewing the battery compartment screw.

Battery replacement

- 2 Remove the battery from the battery compartment.
- 3 Unplug the battery connector.

Inserting the battery

- 4 Connect the battery connector, the instrument will turn on automatically.
- 5 Insert the battery into the battery compartment.



Notice!

Make sure that the battery and its cables are fully inserted inside the compartment before closing the cover to avoid possible damage to them.

- 6 Replace the cover on the battery compartment.
- 7 Tighten the screw on the battery compartment.



Warning!

- In case of replacement use only original batteries to be ordered from Senseca Italy Srl. Use of non-original batteries will void the warranty.
- If you have any doubts regarding the type of battery to be used or its purchase, please contact your local distributor for further information.

5.6 External power supply

The instrument can be used with the power cord connected to one of the following external power sources:

- computer
- power-bank
- with power supply to the mains.

Using power supply via USB port

When the instrument is connected to the external power supply, it can operate properly with or without batteries installed.



Notice!

If you use XPT800 without batteries and the power supply is interrupted, you may lose data.



Warning!

In case the instrument is externally powered or is charging, do not remove the power cord before turning off the instrument. Removing the power cord with the instrument still on could result in the loss of unsaved data.





Info

The instrument can also be powered with the optional RJ12 connector (12- 24 V/1 A), OH3A hardware option.

6 Switching on and off

6.1 Switching on

| | |
|--|--|
| <p>1 Press the ON key briefly:</p> <ul style="list-style-type: none"> • the white LEDs of the LEFT/RIGHT buttons light up • the green LED of the ON button blinks |  |
| <ul style="list-style-type: none"> • the screen turns on • the splash screen is briefly displayed • the main screen appears (ICON MENU) <p>Note: If Auto-Load setting (10.4.3) is active, the SLM measurement screen appears directly</p> |  |

6.1.1 Automatic power-up and scheduled logging start

XPT80X has a function that allows the instrument to be programmed to switch on and start measuring automatically. If a measurement time is set with automatic stop (see also [9.2 “Setting the duration of a measurement”](#) on page 67), it is possible to set the device to automatically switch off at the end of the measurement (see [6.3.1 “Auto Power-OFF”](#) on page 47).

Scheduled logging

Set the scheduled recording in:



SETTINGS > DATALOGGER > SETUP

| Parameter | Value | Description | |
|-------------------|--------|-------------|-------------------------------------|
| Scheduled logging | Weekly | MO | Switch-on every Monday |
| | | TU | Switch-on every Tuesday |
| | | WE | Switch-on every Wednesday |
| | | TH | Switch-on every Thursday |
| | | FR | Switch-on every Friday |
| | | SA | Switch-on every Saturday |
| | | SU | Switch-on every Sunday |
| Daily | Abs | hh:mm | Switch-on time in hours and minutes |
| | | hh:mm | Switch-on time in hours and minutes |
| | | gg/mm/yyyy | Date of switch-on |

| | | |
|-----|-------|-------------------------------------|
| | hh:mm | Switch-on time in hours and minutes |
| Off | | Switch-on disabled |

Start the procedure

Manual switch-off: after the configuration of the scheduled logging, if the instrument is switched off manually and the scheduled switch-on enabled and set, the switch-off icon shows an hourglass indicating that the instrument is scheduled to switch on automatically at the programmed time.



Automatic switch-off: after the configuration of the programmed logging, if the automatic switch-off of the instrument is set (see [6.3.1 “Auto Power-OFF”](#) on page 47), the instrument automatically switches off and waits for the switch-on time. When waiting for automatic switch-on, the white LEDs above the keyboard function keys flash every 15s.

The automatic switch-on takes place approximately 30s before start-up to allow for proper sensor power supply. When restarting, a pop-up is offered (closes automatically after a few seconds) allowing the operator, if necessary, to cancel the start of automatic recording.

If a measurement duration is set and the *Auto power-off* parameter is active (the parameter must be saved in the setup otherwise it is lost on restart) the instrument automatically switches off at the end of the programmed measurement.



Notice!

Set the restart with an appropriate time lag of at least several minutes to allow the automatic procedure to be correctly activated.

6.2 Display auto-off function

The function, if activated, turns off the display after a predetermined time. Refer to chapter [“7.4.2 Setting the display auto power off”](#) on page 51 to enable, disable or set this function.

With Timer display function active ( icon present in the drop-down menu):

- successively access the pages SETTINGS > INTERFACES > DISPLAY and set a time between 1' and 1h;
- if the instrument is not used, the display will turn off after the set time;
- press any key or the display to exit the stand-by mode.

With display timer function NOT active ( icon present in the drop-down menu):

- the display never turns off even if the instrument is not used for a long time.



Notice!

Using the instrument with stand-by function NOT active significantly reduces battery life, it is highly recommended to use this function.

6.3 Switching off

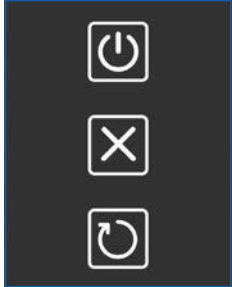
| | |
|---|---|
| <p>1 Access the ICON MENU (see “Fig. 5 – Home page” on page 23) to display the menu control bar.</p> |  |
| <p>2 Press the ON/OFF icon on the control bar for 3 seconds to access the OFF panel.</p> <p>3 Press the desired icon:</p> <ul style="list-style-type: none"> • Upper icon to switch off the instrument • Central icon to cancel the operation and close the OFF panel • Lower icon to restart the instrument. |  |



Warning!

In case the instrument is externally powered or is charging, do not remove the power cord before turning off the instrument. Removing the power cord with the instrument still on could result in the loss of unsaved data.

6.3.1 Auto Power-OFF

The Auto Power-OFF function allows the instrument to be programmed to switch off automatically. Automatic power-off is possible when the measurement is stopped and if there is no user activity on the GUI.

Set the automatic power-off in:



SETTINGS > INSTRUMENT > SYSTEM

| Parameter | Value | Description |
|----------------|-------|---|
| | 1m | |
| | 2m | |
| | 5m | |
| Auto power-off | 10m | After the set time has elapsed, the instrument switches off automatically |
| | 20m | |
| | 30m | |
| | 1h | |

7 Settings and Adjustments

7.1 Set current date and time



Info

If the instrument is connected to the NTP server, you do not need to set the date and time. If you want to manually set the time and ignore any synchronization, you need to change the NTP server connection setting, see the chapter “7.2 Using NTP server to synchronize date and time” on page 49.



Notice!

Stop the measurement before setting the date and time, otherwise the new setting will take effect only at the next recording stop.

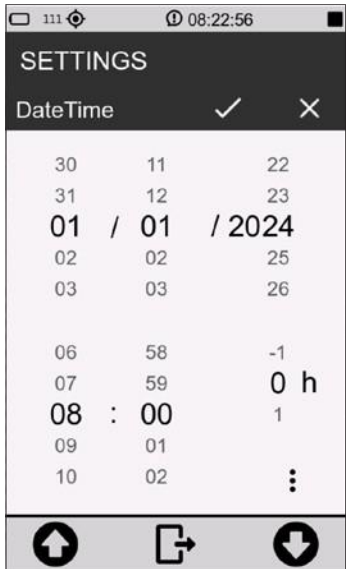
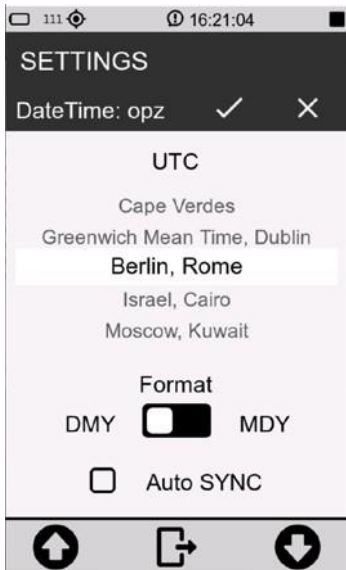
| | |
|--|---|
| <ol style="list-style-type: none"> 1 In the ICON MENU, press the SETTINGS icon to access the system and measurement configuration menus. 1 Successively access the pages INSTRUMENT, SYSTEM and Date & time. 2 Set the date, time and possible daylight-saving time correction. 3 Press ✓ to confirm, press ✗ to cancel the operation. |  |
| <ol style="list-style-type: none"> 4 Press on the three dots ⋮ to access the panel for selecting UTC and date format: <ul style="list-style-type: none"> • DMY = day/month/year • MDY = month/day/year 5 Press ✓ to confirm, press ✗ to cancel the operation. |  |

7.2 Using NTP server to synchronize date and time

XPT800 communicates with NTP servers to synchronize the internal clock with the most accurate time. This requires a valid Internet connection via Ethernet, GSM, or Wi-Fi; to make a connection to a network, see the section “[12 Network and connections](#)” on page [138](#).

For synchronization via NTP server to be possible, it is necessary that the parameter **SETTINGS > INTERFACES > NETS > NTP service** is set to ON.

- 1 Access the panel for setting the current date and time.
- 2 Activate the item Auto SYNC.
- 3 Press ✓ to confirm, press ✕ to cancel the operation.

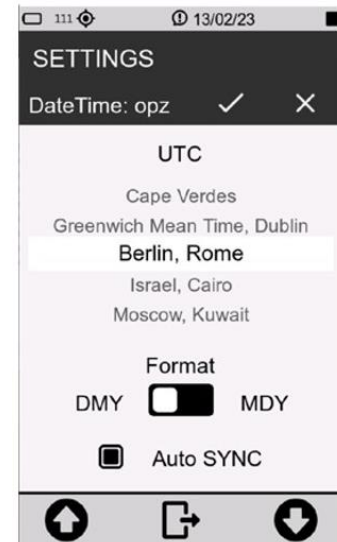

Notice!

The time required for updating the date and time by NTP server depends on the network access speed.

7.3 Setting the language

XPT800 has a built-in language translation function, and language preference can be set. For information on available languages, please refer to the sales department.

- 1 In the **ICON MENU**, press the **SETTINGS** icon to access the system and measurement configuration menus.
- 2 Successively access the pages **INSTRUMENT**, **SYSTEM** and
- 3 **Language**.
- 4 Set the desired language.
- 5 Press ✓ to confirm, press ✕ to cancel the operation.

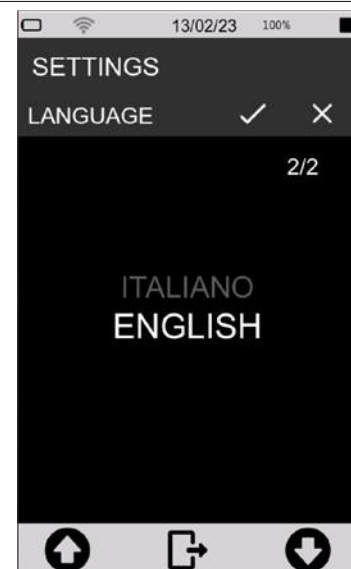

**Notice!**

Some languages may not be available with the firmware installed. Therefore, it is recommended to update the firmware periodically to have any new languages available.

7.4 Display adjustments

7.4.1 Adjusting the brightness

The brightness level is displayed in the status bar through the brightness adjustment slider. There is, in addition, an icon for activating automatic brightness adjustment.

To adjust the brightness of the display:

- 1 Access the status bar.
- 2 Scroll the slider, left to decrease and right to increase the brightness.
- 3 If you are working in an environment with significant lighting variations, it is recommended that you turn on automatic dimming using the appropriate icon



7.4.2 Setting the display auto power off

To set the display auto-off time.

- 1 In the ICON MENU, press the **SETTINGS** icon to access the system and measurement configuration menus.
- 2 Successively access the pages **INTERFACES**, **DISPLAY** and **Display timer**.
- 3 Select the desired auto-off time.
- 4 Press ✓ to confirm, press ✕ to cancel the operation.

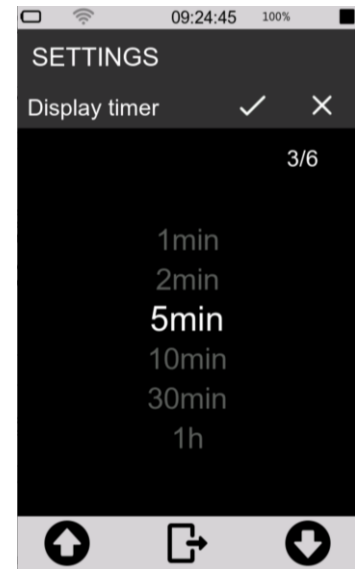

7.4.3 Selecting the display theme

- 1 In the ICON MENU, press the **SETTINGS** icon to access the system and measurement configuration menus.
- 2 Successively access the pages **INTERFACES**, **DISPLAY** and **Colors theme**.
- 3 Set the desired mode.
- 4 Press ✓ to confirm, press ✕ to cancel the operation.

Changing the selected theme is visible only by returning to the ICON MENU.

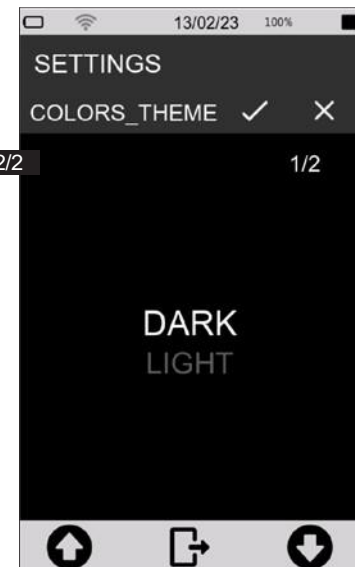

7.4.4 Turning the TOUCH display on and off

With touch display activated, it is possible to operate directly on the display; if deactivated, it is possible to operate the device only through the keyboard. To reactivate the touch display it is necessary to operate through the keyboard. When the instrument is restarted, the parameter is reset and touch functionality re-enabled.

To turn the touch display on and off:

- 1 In the **ICON MENU**, press the **SETTINGS** icon to access the system and measurement configuration menus.
- 2 Successively access the pages **INTERFACES**, **DISPLAY** and **Display touch**.
- 3 Select the desired option (**OFF** to deactivate; **ON** to activate the touch display).
- 4 Press ✓ to confirm, press ✕ to cancel the operation.

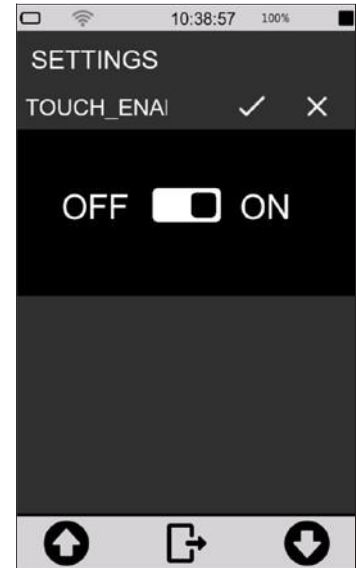

8 Viewing modes



Info

Display modes are available by accessing the MEASURE menu from the ICON MENU.

XPT800 calculates all broadband acoustic parameters in parallel with all available weighting filters. It allows parameter calculations with linear, exponential and moving averages. It also allows real-time and parallel calculations of broadband parameters with spectra in octave or third-octave bands. Functions for statistical analysis allow 7 percentile levels of broadband parameters and frequency spectra to be calculated in octave or third-octave bands; in addition, level distribution and cumulative functions are calculated.

The set of acoustic parameters selectable for display in the various graphical screens is completely independent of the set of parameters or groups of parameters selected for storage and datalogging. The parameters available for display are the full set while the parameters subject to storage are user-selectable through specific panels (see datalogging setup section).

The screens available for displaying data in numerical or graphical format are described below:

SLM (Sound Level Meter)

- 6 user-selectable parameters;
- Difference of levels (selectable);
- Bar graph of 3 broadband levels;
- Display by colored icons of alarms triggered by exceeding settable thresholds;
- Display date and time of occurrence of integrated parameters (e.g., Max-Min).

TABLE

- All broadband parameters, weightings and time constant in parallel: Instantaneous, Average, Max-Min;
- 7 x Ln broadband percentiles, Ln moving, 7 x Ln for 1/1 or 1/3 octave frequency bands;
- Spectrum: Instantaneous, Min, Max, Average, Mov, Ln;
- Exceedances: current exceedances;
- No. of occurrences (SLM, Marker, Audio).

FREQUENCY SPECTRUM (Histogram)

- 1/1 or 1/3 octave histograms: up to 4 selectable with activatable/deactivatable traces. Numerical values @cursor position, Avg, Max, Min, Inst. Three broadband values histograms A, C, Z, U dependent on user setting;
- Selectable linear or weighted spectrum;
- Time constants: Lin, Fast or Slow;
- Type: Inst, Mov, Avg, Max, Min, Rep-Avg, Rep-Max, Rep-Min, Evn-Avg, Evn-Max, Evn-Min.

TIME HISTORY

- 4 time traces of user-selectable parameters;
- Three broadband values histograms A, C, Z, U dependent on user setting;
- Display by colored icons of alarms triggered by exceeding settable thresholds;
- 5 horizontal bar indicators representing eventualities such as audio recordings or sound events;
- Positionable graphic cursor with time and level indication.

FFT

- FFT spectrum navigation graph for frequency range selection to be displayed in the main graph;
- Main FFT spectrum. Numerical values @cursor position;
- Frequency scale Lin or Log selectable;
- Frequency scale zoom function;
- Zoom scale function
- Inst or Medium spectrum display.

SPECTROGRAM

- 1/1 or 1/3 octave histogram navigation chart.
- Spectrogram main graph in colour map with level/frequency/time representation;
- Table with numerical values Avg, Max, Min, Inst @ cursor position;
- Spectrum type selection displayed;
- Frequency scale zoom function;
- Zoom scale function

STATISTICS

- Combined graph of the percentage distribution of levels and cumulative percentage.
- Graphic cursor for selecting and displaying numerical values represented in graphs
- Table with 7 settable percentiles in the system properties

8.1 SLM view

All displayed parameters can be freely chosen from those available. There are no constraints in the choice of frequency weightings. Measurement parameters are displayed with an abbreviated label, followed by the numerical value and the unit of measurement, possibly followed by the frequency weighting. The correspondence between the label and the actual parameter is provided in the appendix.

To display in SLM mode:

- from the home page select MEASURE menu;
- Use the icons < > to access the SLM screen.

Table 4 - SLM mode

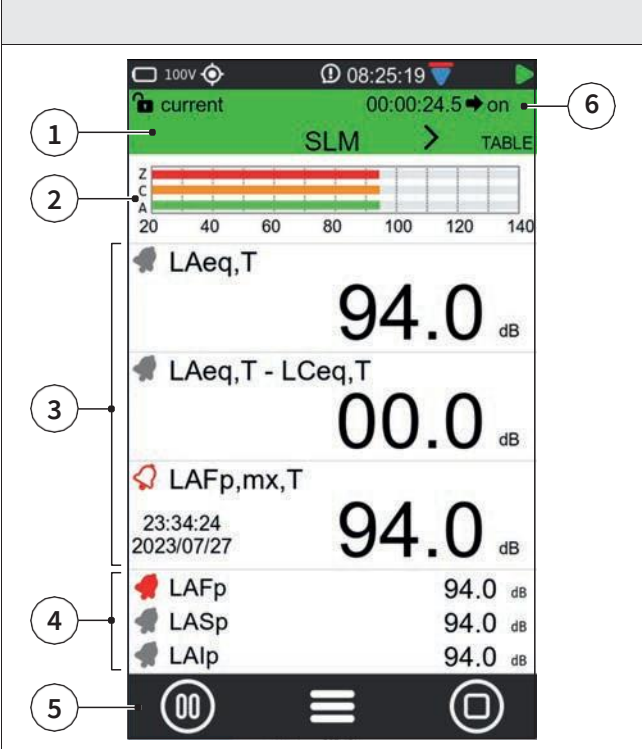
| | |
|---|---|
|  <p>The screenshot shows the SLM mode interface. At the top, there is a measurement status bar (1) with a green background and 'SLM' text. Below it is a pseudo-analog bar (2) showing three levels (Z, C, A) with a scale from 20 to 140 dB. The primary parameter (3) is 'LAeq,T' with a large font value of '94.0 dB'. Below it is the secondary parameter (4) 'LAeq,T - LCEq,T' with a value of '00.0 dB'. Further down is another secondary parameter 'LAFp,mx,T' with a value of '94.0 dB' and a timestamp '23:34:24 2023/07/27'. At the bottom, there are three secondary parameters: 'LAFp', 'LASp', and 'LAIp', all with a value of '94.0 dB'. The bottom navigation bar (5) contains a stop button, a menu icon, and a square button. The acquisition time (6) is '00:00:24.5' with a 'on' indicator.</p> | <ol style="list-style-type: none"> 1 Measurement status bar: <ul style="list-style-type: none"> • white when stopped; • green when measurement is in progress; • yellow when paused. 2 Pseudo-analog bar (dB): graphically shows 3 broadband levels 3 Primary parameters: with large font 4 Secondary parameters: with small font 5 Measurement control bar and context menu 6 Acquisition time: in hours: minutes: seconds |
|---|---|

In this mode it is possible to:

- **Enable subtraction between two parameters:** the obtained numerical value will be displayed in real time. Subtraction is possible only for the three primary parameters and not for the three secondary parameters.
- **Selection of parameters to be displayed.**
- **Set Exceedances on/off.**
- **Perform a measurement with or without recording.**

8.2 TABLE view

Table mode provides numerical values of significant groups of preset parameters, the display of which cannot be changed, in the Instantaneous, Averages, Maximum-Minimum and SLM Exceedances screens. Spectrum screen provides numerical values in octave bands or third of octave of acoustic parameter groups selectable by touch from % (7 user-parameterizable percentile levels), Inst (instantaneous or moving-average spectra), GLB (integrated max, min, equivalent, moving spectra), REP (max, min, equivalent, moving spectra, calculated at Report time intervals), EVN (max, min, equivalent, moving event spectra).

To access the TABLE mode:

- 1 from the home page select MEASURE menu;
- 2 Use the icons < > to access the TABLE screen;
- 3 Use the arrows on the navigation bar to display the desired items.

Table 5 - TABLE mode

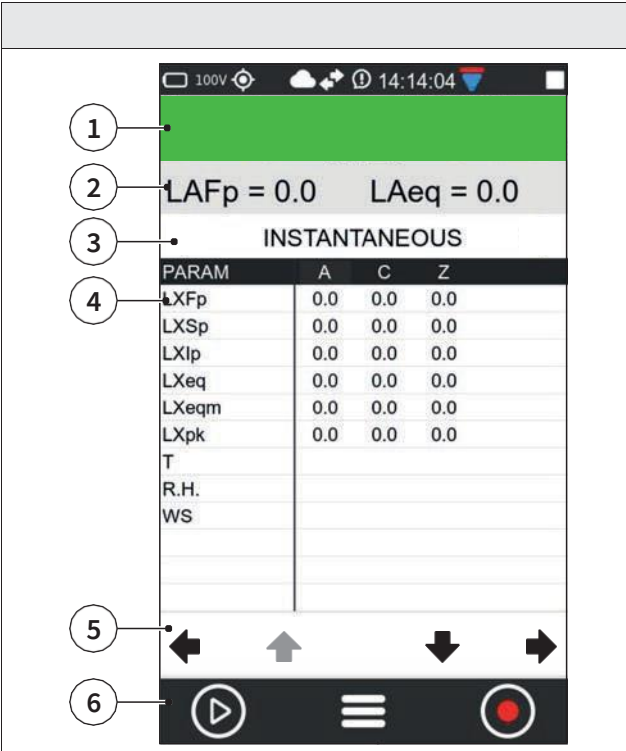
| | |
|--|--|
|  | <ol style="list-style-type: none"> 1 Measurement status bar: <ul style="list-style-type: none"> • white when stopped; • green when measurement is in progress; • yellow when paused. 2 Measurement instantaneous reference parameters 3 Page with instantaneous values 4 Display of measured values 5 Item navigation bar 6 Measurement control bar and context menu |
|--|--|

In this mode the following items can be displayed.

INSTANTANEOUS

Shows instantaneous total values (broadband).

AVERAGES

Shows time-integrated measurement values of significant broadband parameter groups.

PERCENTILE AVERAGES

Shows the integrated values of the 7 percentile levels (values of the 7 percentiles that can be set in the menu SETTINGS > SOUND MEASURE > STATISTICS).

The four columns display respectively:

- LN broadband values integrated with linear average;

- LN broadband values integrated with moving average (the number in seconds indicates the duration of the integration moving window);
- LN values referring to # 1 frequency band (selectable); only if spectrum statistics activated (Reports, Events, Globals) and spectrum order=3 (1/3 oct)
- LN values referring to # 2 frequency band (selectable); only if spectrum statistics activated (Reports, Events, Globals) and spectrum order=3 (1/3 oct)

MAXIMUMS - MINIMUMS

Shows maximum and minimum integrated values of significant broadband parameter groups.

SPECTRUM

Shows instantaneous, minimum, maximum and average values in third-octave or octave (depending on instrument settings) or frequency band values of other selectable parameters (LN percentile levels, events, ratios).

The parameter displayed on the column is user selectable.

SLM EXCEEDANCES

Shows the following exceedances:

- parameter exceeded;
- input/output thresholds;
- exceedance status (bell); light grey (detection not active), dark grey (detection active), red (ongoing exceedance)
- exceedances count.





MARKERS

Provides a count of the number of sound events (divided by name) identified by automatic or manual marker that occurred during a measurement. A symbol representing a bell indicates whether the trigger condition of the marker or event is active or inactive.

DETECTORS

Shows:

- Cnt: counting the number of activations of automatic detectors verified during a measurement.
- Status (bell): light grey (detection inactive), dark grey (detection active), red (detection in progress)

| DETECTORS | | |
|-----------|---|-----|
| Parameter | | Cnt |
| TONALI |  | 0 |
| DM 160398 |  | 0 |
| ISO 1996 |  | 3 |
| DET4 |  | 0 |

REVERBERATION

Provides the values in octave band or third octave band (depending on the setting) of the following parameters:

- **T60** calculated on (selectable) dynamics
 - T-best: on maximum possible dynamics
 - T20: on 20dB dynamics
 - EDT: dynamic Early Decay Time
- **Correlation R** of the regression line (selectable)
 - R-best: on maximum possible dynamics
 - R-T20: on 20dB dynamics
 - R-EDT: on dynamics Early Decay Time
- **Linearity L** of the decay curve calculated on (selectable) dynamic
 - L-best: on maximum possible dynamics
 - L-T20: on 20dB dynamics
 - L-EDT: on dynamics Early Decay Time

SLM < TABLES > OCTAVE

LAFp = 52.0 LAeq = 50.8

REVERBERATION 1/3

| Freq. | Best-T | T20-R | Best-L |
|-------|--------|-------|--------|
| 800 | 0.55 | 0.955 | 6.0 |
| 1k | 0.57 | 0.985 | 4.9 |
| 1.25k | 0.61 | 0.996 | 4.1 |
| 1.6k | 0.62 | 0.993 | 7.2 |
| 2k | 0.60 | 0.992 | 3.9 |
| 2.5k | 0.64 | 0.996 | 2.0 |
| 3.15k | 0.63 | 0.997 | 2.4 |
| 4k | 0.63 | 0.999 | 2.2 |
| 5k | 0.65 | 0.998 | 2.1 |

8.3 Octave and Third Octave

The frequencies and amplitudes of the sound signal analyzed through IEC61260-compliant constant percentage band digital filters are displayed in real time through a bar graph called a histogram. The graph allows superimposition and activation or deactivation of 4 different color curves related to user-selectable parameters and calculation modes even during measurement.

To access the OCTAVE mode:

- 1 from the home page select MEASURE menu;
- 2 Use the icons < > to access the OCTAVE screen;
- 3 Use the icons in the display.

Table 6 – OCTAVE mode

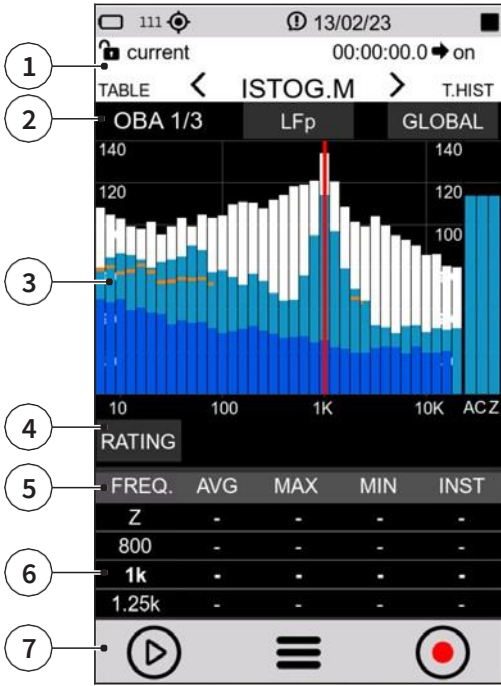
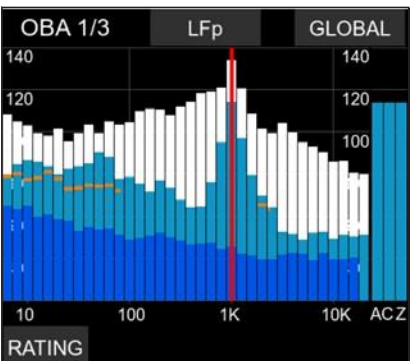
| | |
|---|---|
|  | <p>1 Measurement status bar:</p> <ul style="list-style-type: none"> • white when stopped; • green when measurement is in progress; • yellow when paused. <p>2 Viewing options:</p> <ul style="list-style-type: none"> • the resolution (octaves or third octave) is displayed on the left. • in the center the spectrum calculation parameter is selectable (LFp - LFeq - LFeqm) • on the right is selectable the type of analysis for the spectrum between (Global - Report - Event) <p>3 1/3 or 1/1 octave spectra (depending on the settings):</p> <ul style="list-style-type: none"> • White (black with LIGHT theme): maximum • Blue: minimum • Light blue: instant • Orange: medium (dependent on parameter setting) <p>4 RATING: allows, if enabled by menu (SETTINGS > SOUND MEASURE > SPECTRA: Sp.rating type), the selection among the rating indices NC, RNC, NR, RC</p> <p>5 Show/hide spectrum, use the keys:</p> <ul style="list-style-type: none"> • AVG • MAX • MIN • INST <p>6 Numerical values of the spectrum:</p> <ul style="list-style-type: none"> • bold value line: selected cursor position • adjacent lines: previous and next frequency <p>7 Measurement control bar and context menu</p> |
|  | <p>Cursor activation: touch the touch screen</p> <ul style="list-style-type: none"> • Left/right arrows: frequency selection • Up/down arrows: change full scale • Zoom icons: change interval |

In this mode it is possible to:

- **Evaluate acoustic Ratings;** tap RATING.
 - **Show or hide a spectrum;** tap the spectrum label to display the desired plot. Label unselected is highlighted in black, for example:
- | | | | | |
|-------|-----|-----|-----|------|
| FREQ. | AVG | MAX | MIN | INST |
|-------|-----|-----|-----|------|
- Avg OFF (Max, Min, Inst ON)
 - Avg + Min OFF (Max, Inst ON)
- | | | | | |
|-------|-----|-----|-----|------|
| FREQ. | AVG | MAX | MIN | INST |
|-------|-----|-----|-----|------|
- **Navigate within the histogram;** tap the histogram to display the cursor (red vertical line), use the display icons to move frequency and increase/decrease scale.



Info

For the complete list of values that the parameter "Spc_analysis_type" can take, see the section ["19 Appendix B - Parameters"](#) on page 160.

8.4 Time History

The Time History graph represents the time profile of several user-selectable acoustic parameters within a time window of defined width. The graph allows visual appreciation and numerical evaluation of the levels of sound events and their amplitude changes as a function of time. In parallel, it allows visual evaluation of the occurrence of sound events automatically detected by the sound level meter or manually highlighted by the operator during measurement for later analysis using post processing software NS-ENS.

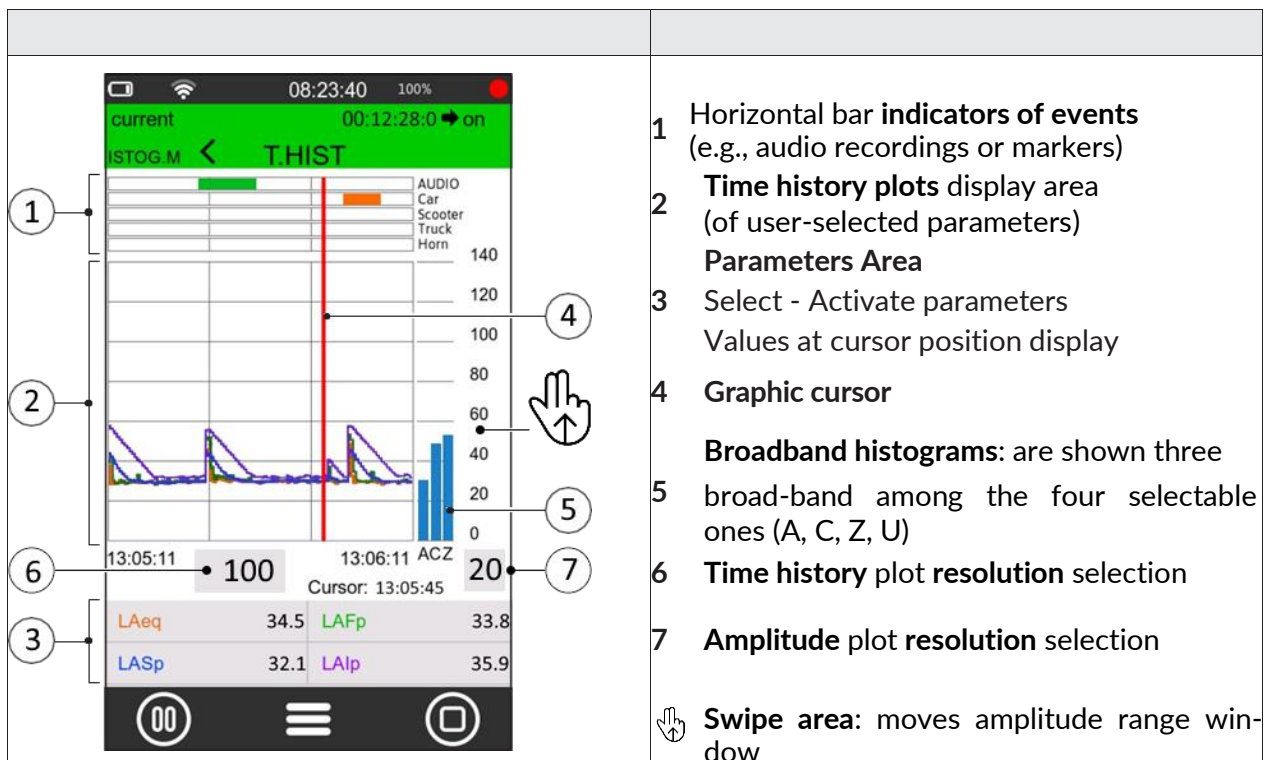

Info

The selection of parameters to be associated with the 4 curves available for the time history graph, can be made through selection wheels. Tap on the parameter to display selection wheels

8.5 Spectrogram

The spectrogram graph is a visual representation of the frequency and level variation of a signal over time. It is commonly used to analyse audio signals, vibrations and other phenomena involving varying frequencies.

Graph axes

- **X-axis (horizontal):** represents absolute time.
- **Y-axis (vertical):** represents the frequency in 1/1 or 1/3 octave bands (the resolution of the bands represented depends on the user setting).

Colour or Intensity

- The colour of the points in the graph represents the amplitude of the signal in dB at a given frequency at a given time.
- In the graduated colour palette, brighter colours (e.g. fuchsia, red) indicate higher signal energy at that frequency, while darker colours (blue) indicate lower energy.

Note: the spectrogram graph is only available if the octave or third octave band analysis option is activated.

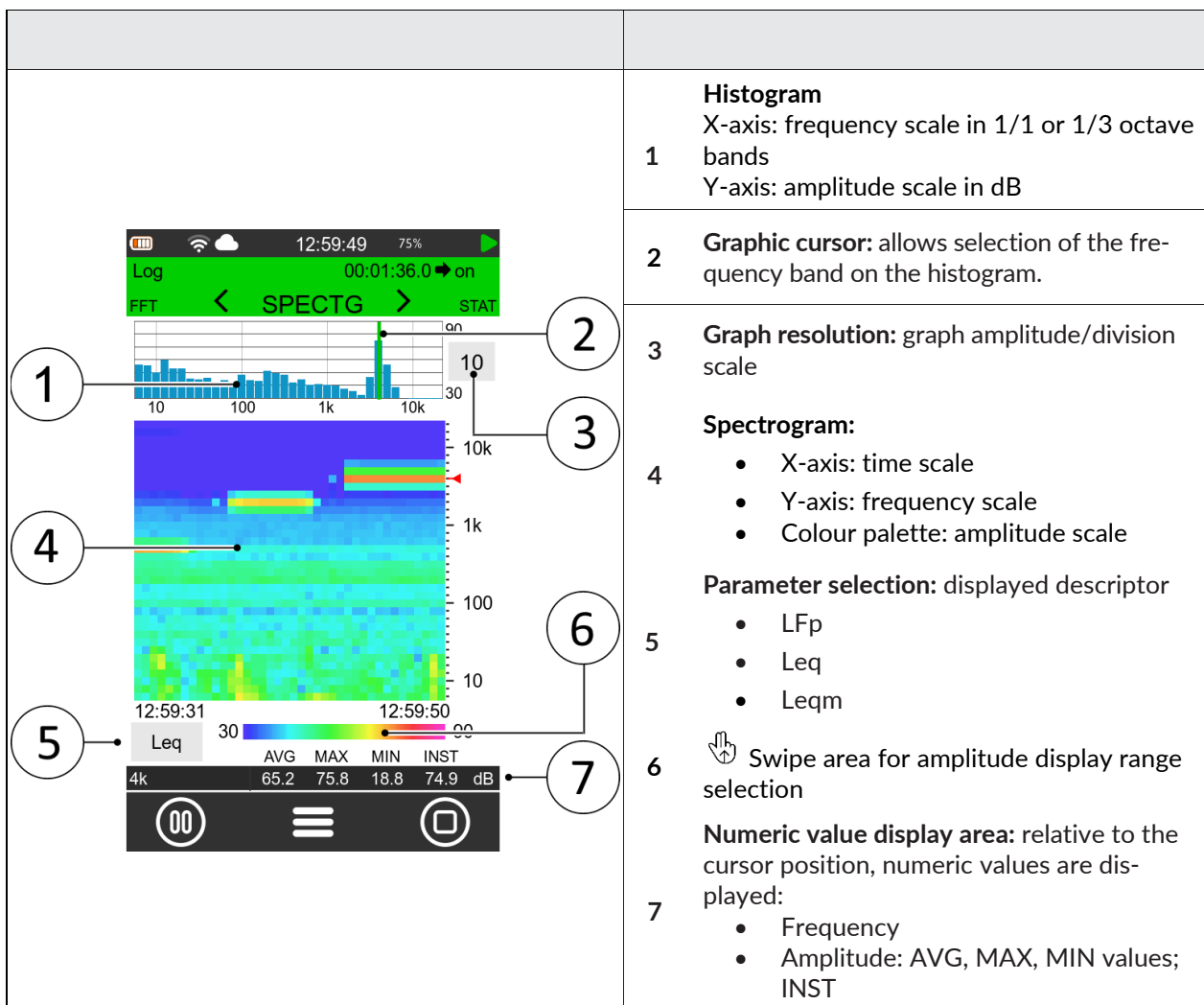

8.6 FFT

The **FFT (Fast Fourier Transform)** graph represents the frequency spectrum of a signal in the frequency domain. It shows how the signal energy is distributed between the various spectral components.

For FFT analysis settings see also [10.13 FFT Spectral Analysis on page 106](#)

Graph axes

- **X-axis (horizontal):** represents the frequency (Hz)
- **Y-axis (vertical):** represents the amplitude of the signal at each frequency

If the signal is periodic, the FFT will show peaks corresponding to its fundamental and harmonic frequencies. If it is noise or a complex signal, the graph will show a continuous distribution of frequency components. **Spectral lines** are distinct peaks in the FFT graph that indicate the presence of sinusoidal components at specific frequencies. These lines represent the pure tones (or harmonics) that make up a complex signal. Spectral lines **allow a signal to be split into its frequency components**.

Peak width: depends on the resolution of the FFT and whether a window is used; for example, a Hanning or Hamming window can widen the peak (see also [10.12 on page 105](#)).

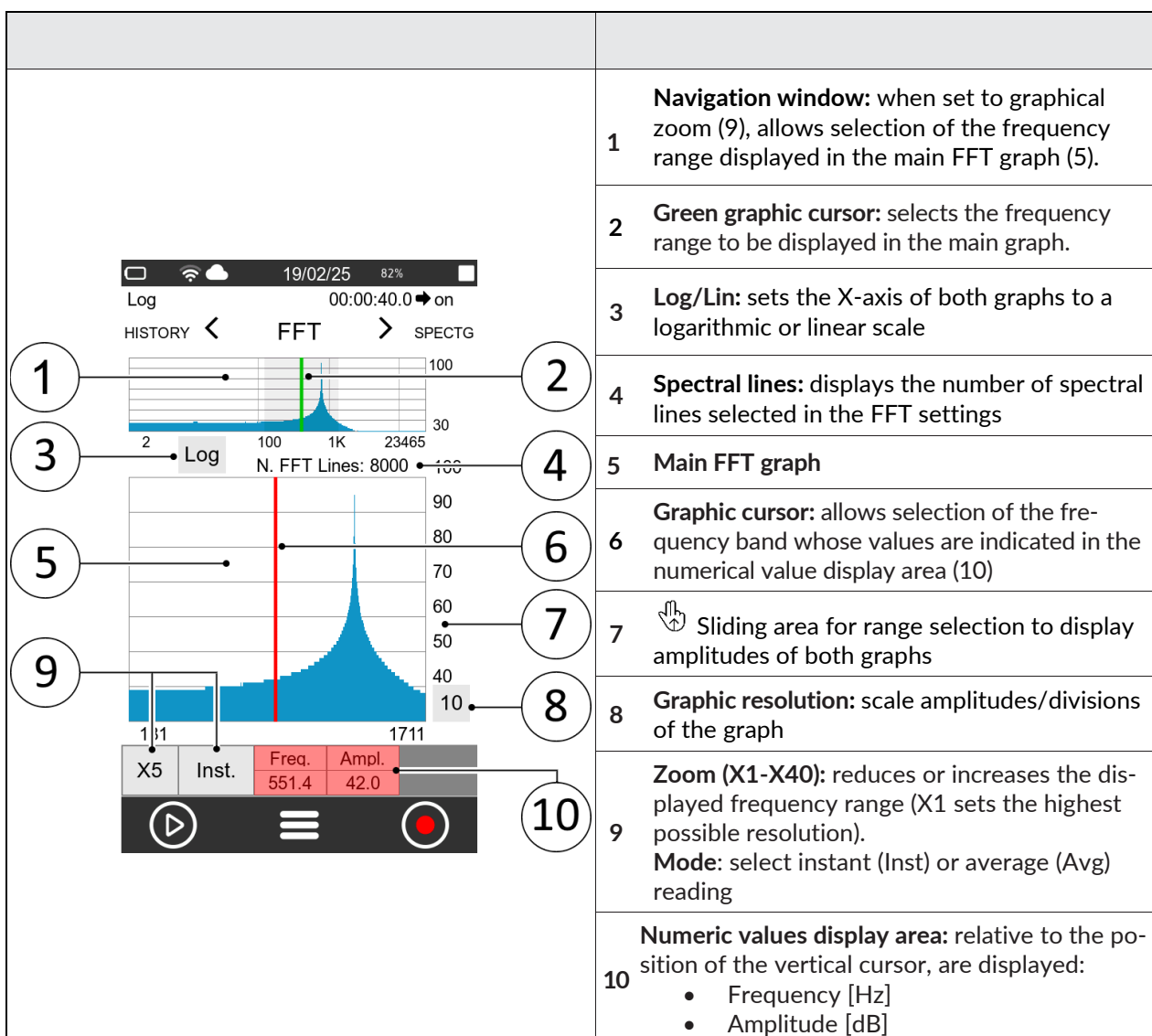

Reading of values and search for peaks

The main graph has a function that allows the fine shift of the vertical cursor for reading frequency and amplitude values and the automatic search for maximum values of spectral lines.

| | |
|--|--|
| | <p>1 Cursor control bar: touch the red cursor to activate the cursor controls (6) of the main window.</p> <ul style="list-style-type: none"> ◀◀ Places the cursor on the spectral band with the highest local value (Max) to the left ◀ Places the cursor on the adjacent spectral band (Next) to the left ✕ Closes the control bar ▶ Places the cursor on the adjacent spectral band (Next) to the right ▶▶ Places the cursor on the spectral band with the highest local value (Max) to the right <p>10 Numeric values display area: relative to the position of the vertical cursor, are displayed:</p> <ul style="list-style-type: none"> • Frequency [Hz] • Amplitude [dB] |
|--|--|

8.7 Statistics

The **Statistics graph** represents the **probability of sound levels p%**, the **cumulative probability cp%** and the **percentile levels Ln** in both graphical and numerical form

Graph axes

- **X-axis (horizontal):** represents the level classes (dB)
- **Y-axis (vertical):** represents on the left, relative to the orange curve, the cumulative probability cp% and on the right, relative to the histogram, the probability of the levels p%.

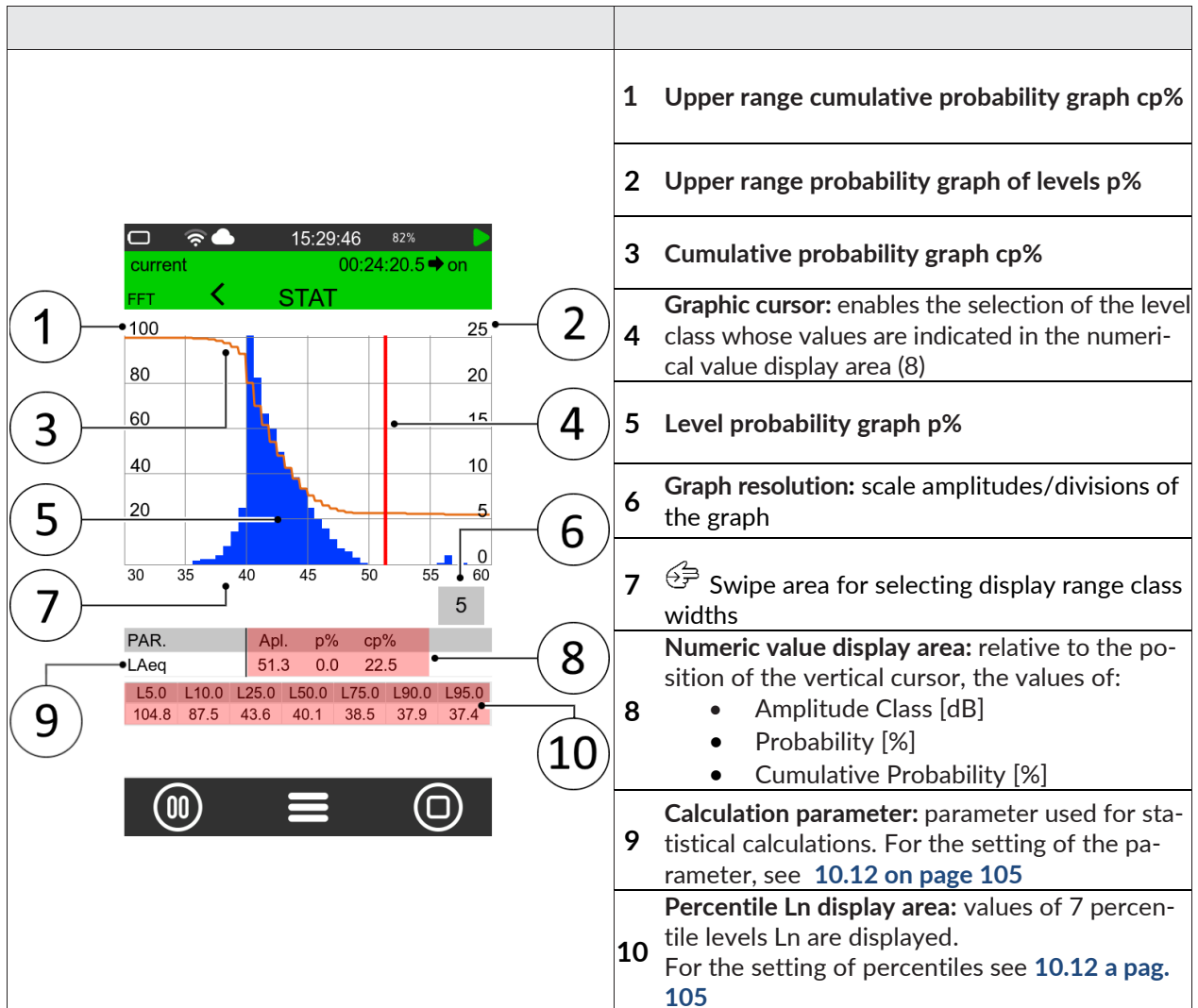

1 Upper range cumulative probability graph cp%

2 Upper range probability graph of levels p%

3 Cumulative probability graph cp%

4 Graphic cursor: enables the selection of the level class whose values are indicated in the numerical value display area (8)

5 Level probability graph p%

6 Graph resolution: scale amplitudes/divisions of the graph

7 Swipe area for selecting display range class widths

8 Numeric value display area: relative to the position of the vertical cursor, the values of:

- Amplitude Class [dB]
- Probability [%]
- Cumulative Probability [%]





9 Calculation parameter: parameter used for statistical calculations. For the setting of the parameter, see [10.12 on page 105](#)

10 Percentile Ln display area: values of 7 percentile levels Ln are displayed. For the setting of percentiles see [10.12 a pag. 105](#)

8.8 Activating or deactivating views

It is possible to enable or disable the panels of available views. If, for a specific application, a particular view is not useful, you can simplify the interface to make it more user-friendly by deactivating unnecessary views. Activation and deactivation can be stored in the user setups.

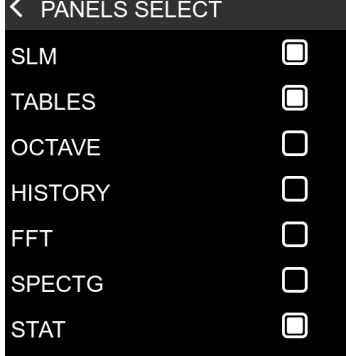
To activate or deactivate a view, proceed as follows.:

| | |
|--|---|
| <ol style="list-style-type: none"> In the ICON MENU, press the MEASURE icon to access the measurement panel.. Tap on the context menu and select EDIT APP |  |
| <ol style="list-style-type: none"> Tap on PANEL SELECT |  |
| <ol style="list-style-type: none"> Tap the check box to activate/deactivate the panel of interest |  |
| <ol style="list-style-type: none"> Exit the panel |  |

To save settings of customized active views in a user setup see [10.4 “Custom measurement setups”](#) on page [85](#)

9 Getting started: Main Functions

The most frequently used functions are described below; for a complete discussion of the instrument operation and settings, see the section “[10 Advanced functions](#)” on page [80](#).

9.1 Calibration

Sound level meter calibration (adjustment) should be carried out periodically, normally before and after each measurement session, in order to ensure the validity of the measurements made by the sound level meter, as the sensitivity of the microphone and the response of the electronic circuits may vary slightly over time or may be affected by environmental conditions such as temperature, atmospheric pressure and humidity.

Acoustic calibration also includes internal electrical calibration. Electrical calibration enables the alignment of electrical parameters in the measurement chain



Info

More information on calibration settings can be found in the chapter “[10.1 Setting the calibration parameters](#)” on page [80](#) “.

- Before starting the calibration procedure, carefully read the calibrator manual provided with the calibrator.



Notice!

- It is recommended to use the model HD2020 calibrator, supplied upon request
- Another class 1 calibrator conforming to IEC60942 and with 1/2" cavity can be used, after verifying compatibility and technical specifications.
- When using class 1 calibrators alternative to the HD2020 model, the nominal emission level stated in the calibration certificate must be verified, and the "Cal_Level" parameter in use in the menu related to the calibration setup must be adjusted. If stated by the manufacturer, corrections per load volume should be considered.

Before performing an acoustic calibration:

- make sure that the environment in which you are operating is suitable: no sudden noise, no vibration are present on the supporting surface, thermal stability of the instrument.
- make sure that the microphone and especially the microphone diaphragm are clean; in case a check of the condition of the microphone capsule is to be performed, refer to “[14.2 Microphone cleaning \(microphone diaphragm\)](#)” on page [151](#);

in case of accessories installed on the instrument, such as a windshield if any, or if you want to customize the calibration settings, refer to section “[10.1.1 Setup](#)” on page [80](#);

- make sure that there is no measurement in progress; if it is, it must be stopped before starting calibration.

To perform a calibration:

- 1 Turn off the sound calibrator.
- 2 Carefully insert the microphone all the way into the cavity of the calibrator.
- 3 Turn on the **XPT800** sound level meter.
- 4 Follow any specific recommendations in the calibrator manual in this regard.

| | |
|--|---|
| <ol style="list-style-type: none"> 5 In the ICON MENU, press the SYS-FUNC icon to access the system app menus. 6 Access the CALIBRATION, PROCEDURE pages in succession. 7 Set in the "Expected" field, if not yet set in the calibration setup (CALIBRATION > SETUP > Level), the nominal value stated by the manufacturer or taken from calibration certificate, of calibrator output (e.g., 94.00) at 1KHz frequency. 8 Press "Play" to start the reading. 9 If the level is enough stable, press "CAL" to start the adjustment procedure. 10 The "CAL" button remains inactive until the calibration procedure is finished, so calibration corrections are not allowed. |  |
|--|---|

11 When done, turn off the sound calibrator, slide the microphone out of the cavity.

When the calibration is completed, the date, time and correction are updated. Access to the *Calibration history* panel is allowed only after the calibration is completed.

9.2 Setting the duration of a measurement



Notice!

If the measurement duration is not set, the measurement will not be interrupted unless manually or when the memory or battery runs out.

| | |
|---|---|
| <ol style="list-style-type: none"> 1 In the ICON MENU, press the SETTINGS icon to access the system and measurement configuration menus. 2 Access the SOUND MEASURE, SETUP and Measure Timer pages in succession. 3 Select the measurement duration. 4 Press \checkmark to confirm, press X to cancel operation. |  |
|---|---|

9.3 Select acoustic parameters to be displayed

The XPT800 sound level meter is capable of simultaneously calculating a very large set of broadband, frequency-band acoustic parameters with different spectral weightings in parallel. Thanks to this feature, it is possible for the user to change at any time, and even with measurement in progress, the parameters displayed in the available screens; thus, the possibilities for investigation of the sound phenomenon in progress will be virtually unlimited



Info

Editing the displayed parameters is also available from the context menu by selecting **EDIT VIEW**.

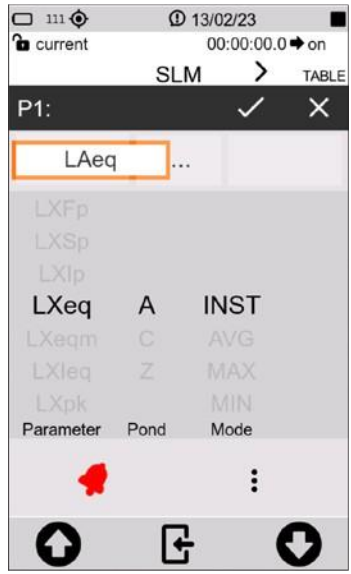
| | |
|--|---|
| <p>6 the ICON MENU, press the MEASURE icon to enter the measurement panel.</p> <p>7 Touch the SLM parameter to be set (example LAeq).</p> |  |
| <p>3 Press on the parameter name (e.g. LAeq) and select the new parameter and available options:</p> <ul style="list-style-type: none"> • First column: here all available parameters classes appear (example LXeq). See. “19.1.3 Classes of measurement parameters available for visualisation” on page 162 • Second column: here you can choose the available options (Weighting or frequency band). • Third column: here you can choose the available options (Integration mode). <p>For a complete description of the available parameters and options, see the section “19 Appendix B – Parameters” on page 160.</p> |  |



Info

It is also possible to:

perform subtraction between two parameters, see chapter “[9.5 Subtraction of two acoustic parameters](#)” on page 72.

set alarms and exceedances, see chapter “[9.7 Set alarms on exceedances](#)” on page 74.

9.4 Set acoustic parameters to be stored

The XPT800 sound level meter allows parallel storage of a very large set of acoustic parameters with sampling down to 10ms. Through the Time History, Report, Events, Globals storage groups, the user has logging tools that allow recording of sound phenomena both with high temporal resolution and with integrated sampling over medium or long times thus being able to quantify sound emissions on an hourly or daily basis, for example, or with hourly moving average integrations. In addition, storage of time histories and calculated acoustic parameter values of occasional events is also possible independently of continuous storage of levels, saving the user, if necessary, from storing data not of interest. The Time History, Report, Events, and Globals storage groups can be used simultaneously, providing the acoustician with a versatile logging tool that can be adapted to any need.



Info

All modified settings remain stored in the "current" and reloaded at power-up. The current setup, if modified, will be followed by an asterisk to indicate to the user that an unsaved change has occurred. If the user wishes, he/she can store the complete set of settings in a setup file by accessing APPLICATION MANAGER which is the application from which to manage the storage of the customized settings, see chapter "10.4 Custom measurement setups" on page 85.

MEASURE > EDIT APP > LOG >

- **SETUP:** setting of general log parameters such as sampling step, moving window, activation/deactivation of storage for specific analysis, time synchronization mode of storage.
- **TIME HISTORY:** activation/deactivation of storage of Instantaneous, Maximum, Minimum, Integrated and Auxiliary acoustic parameters, in Time History group.
- **REPORTS:** activation/deactivation of parameter storage and report interval, in Report group.
- **EVENTS:** activation/deactivation of storage of stored parameters, in Event group.
- **GLOBALS:** activation/deactivation of parameter storage in Globals group. Setting the calculation mode CONT or DAILY (Tba).
- **AUDIO:** activation/deactivation of audio recording in Continuous or Event mode. Setting of sampling and resolution characteristics, compression and maximum duration of audio recording.

1 In the ICON MENU, press the **MEASURE** icon to access the measurement panel.



2 Tap on the context menu and select **EDIT APP**.

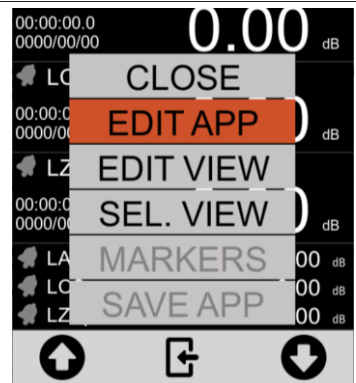

3 Select **LOG**.



4 Select the required datalogging group (example **TIME HISTORY**).

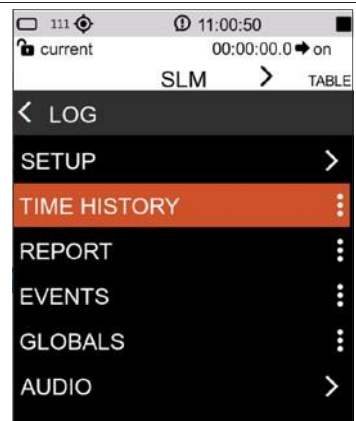

- 5 Tap the check box to select one or more parameters to be recorded.



Info

The Time History logging interval setting can be found on the EDIT APP > LOG > SETUP page.

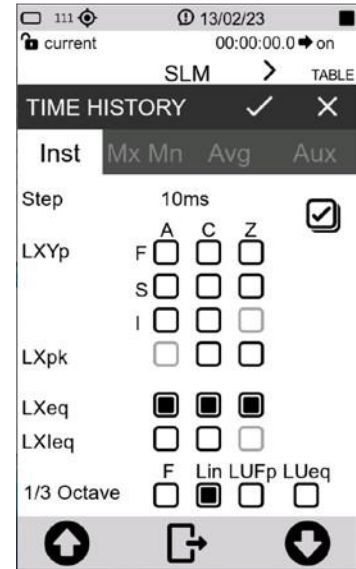

Info

The Reports logging interval setting can be found on the EDIT APP > LOG > REPORTS panel

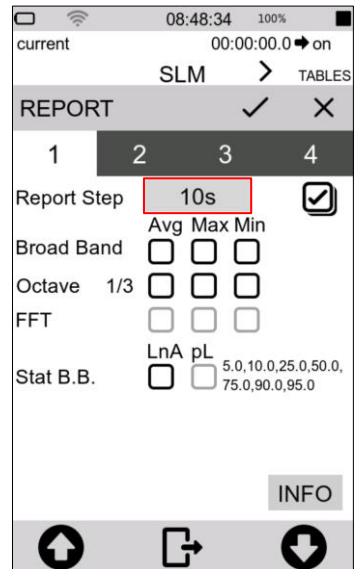

9.5 Subtraction of two acoustic parameters

For specific measurement applications, it may be necessary to directly detect the level difference between two acoustic parameters whose correlation is significant for the evaluation of a sound event. The **XPT800** allows direct display calculation of the difference between any two freely selectable acoustic parameters such as, for example, LAeq - LAeq to evaluate the impulsive character of a sound source, LCeq - LAeq in noise exposure assessment or PPE evaluation using the HML method

- 1 In the ICON MENU, press the **MEASURE** icon to access the measurement panel.
- 2 Select the parameter to which you want to apply the subtraction (example LAsp),



Info

it is only possible for the three primary parameters (big numbers) and not for the three secondary parameters (small numbers)



- 3 Tap on the center field to activate the subtraction function, the " - " subtraction sign appears.

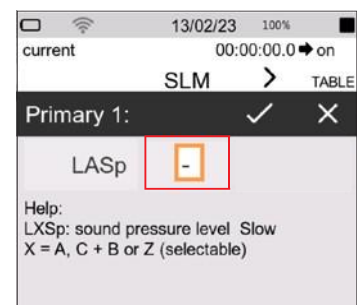

- 4 Tap the right field to select the second parameter.
- 5 Press \checkmark to confirm, press **X** to cancel operation.



Info

To modify the displayed parameters, see “[9.3 Select acoustic parameters to be displayed](#)” on page 68 .

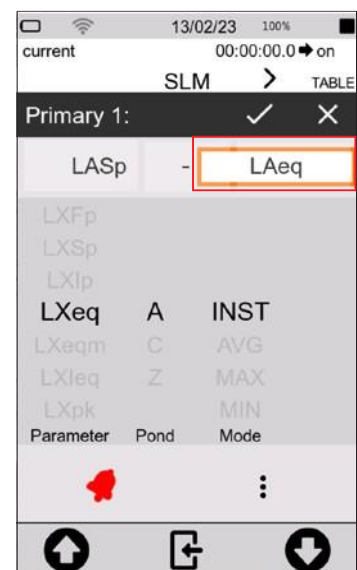

9.6 Load a custom configuration

To load an existing configuration, follow the steps below.:

- 1 In the ICON MENU, tap the **APPLICATION MANAGER** icon to access to the custom measurement app selection and management panel.
- 2 **Select and load the configuration by tapping on it directly**

Or:

- 3 **tap at least 2 seconds** and use the context menu controls. Select **LOAD**

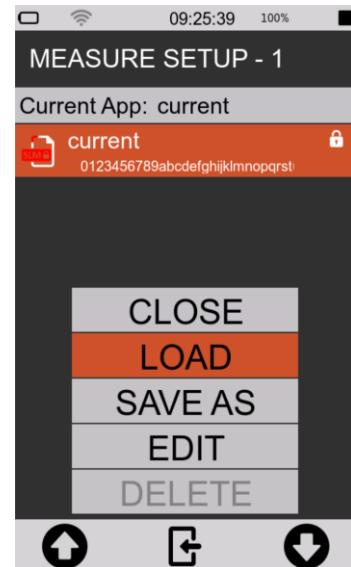

- 4 The configuration is immediately activated and ready for use.



Info

The name of the loaded configuration is shown on the upper left part of the screen



Info

For a full explanation of custom configurations, see the chapter “[10.4 Custom measurement setups](#)” on page [85](#).

9.7 Set alarms on exceedances

The function allows specific actions to be automatically triggered when specific conditions are reached such as exceeding a certain noise level detected by the instrument for a certain acoustic descriptor. Reaching the triggering conditions can, for example, automatically generate recording of the audio signal when the noise level exceeds a certain value and stopping recording when the level returns below the set value.

- 1 In the ICON MENU, tap on the **MEASURE** icon to access the measurement panel.
- 2 Tap on the SLM parameter to be set.



- 3 Select the parameter used for exceedance/alarm, to change the parameter to be set see chapter “[9.3 Select acoustic parameters to be displayed](#)” on page 68.
- 4 Tap the bell to activate (the bell turns red when active).
- 5 Tap the three dots to set the threshold.

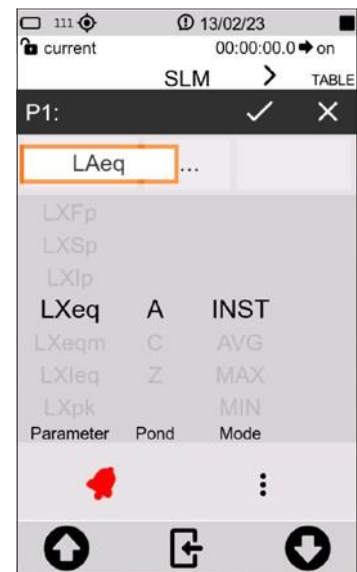

6 Enter the threshold values, mode and duration (see also “20.1 Exceedances settings” on page 168). Changes are directly activated by going back.

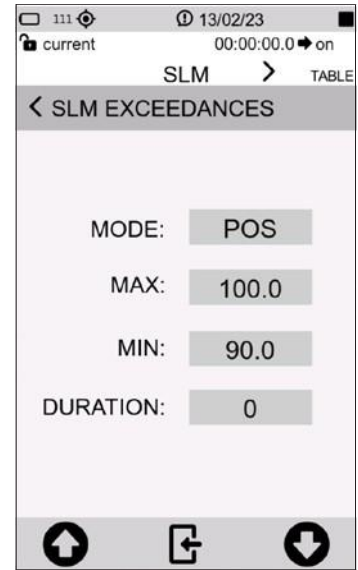

7 The black bell indicates that the alarm is ready and waiting for the threshold to be exceeded.

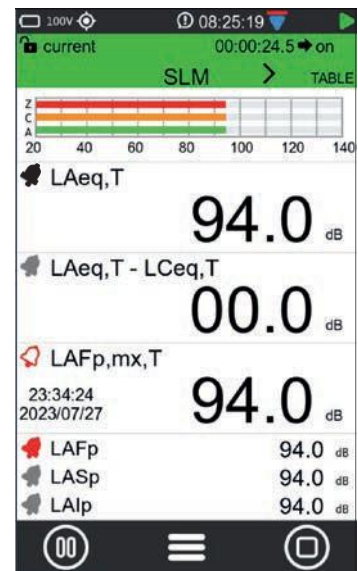

8 Description example of exceedance/alarm status.

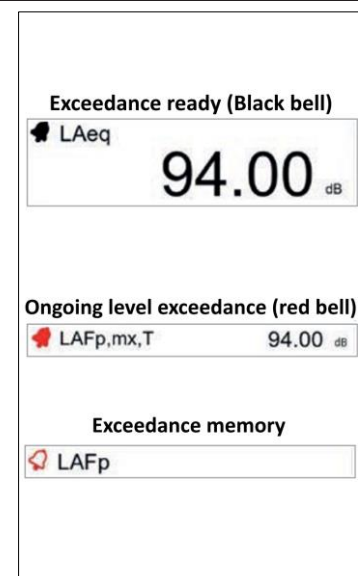

9.8 Starting and stopping a measurement

The XPT800 sound level meter allows measurements of sound levels even without data storage. The two measurement modes, with and without datalogging, use common acoustic descriptors calculation functions. Through the graphical interface, the choice of measurement mode is made by means of commands available on the measurement control bar. In the status bar, a specific icon indicates the active measurement mode.



Notice!

- With this mode, there is no recording of measurements. Values will not be stored, only displayed.
- When measuring outdoors with high humidity and using the outdoor microphone unit, it is recommended to use the preamplifier heater, see “10.8 Activating the preamplifier heater” on page 93.

| | |
|---|--|
| <ol style="list-style-type: none"> 1 In the ICON MENU, press the MEASURE icon to access the measurement panel or select a pre-configured configuration, see chapter “9.6 Load a custom configuration” on page 73. 2 Tap the left icon of the control bar to perform the measurement without datalogging. | |
| <ol style="list-style-type: none"> 3 Measurement in progress (see the green arrow measurement icon in the upper right corner). 4 Tap the left icon to PAUSE, press again to resume measurement. 5 Tap the right icon to STOP measurement, no data will be stored. | |

9.9 Starting and stopping a measurement with datalogging

The XPT800 sound level meter enables measurements of sound levels with data storage. The measurement mode uses common calculation functions. Through the graphical interface, the choice of measurement and storage mode is made through commands available on the measurement control bar. In the status bar, a specific icon indicates the active measurement mode. The measurement mode with logging assumes that the user has set the desired measurement parameters in the LOG menu. The LAeq parameter is always stored even if the user has not selected any parameters.



Notice!

- With this function, the measurement is recorded, the data will be stored.
- When measuring outdoors with high humidity and using the outdoor microphone unit, it is recommended to use the preamplifier heater, see “10.8 Activating the preamplifier heater” on page 93.

| | |
|---|--|
| <ol style="list-style-type: none"> 1 In the ICON MENU, press the MEASURE icon to access the measurement panel or select a pre-configured setup, see chapter “9.6 Load a custom configuration” on page 73. 2 Tap the right icon of the control bar to perform the measurement with datalogging. | |
| <ol style="list-style-type: none"> 3 Measurement in progress (see the red circle measurement icon in the upper right corner). 4 Tap the right icon to STOP measurement, data will be automatically stored. | |

9.10 Recording audio manually

The Audio function allows the sound signal from the sound level meter transduction chain to be recorded at the same time as the measurement parameters. The signal thus recorded can be used for replay by means of an audio playback program or through the NS-ENS software module. The instrument allows recording to be triggered either manually or automatically through user-settable trigger functions. Manual and automatic modes can also be used in conjunction during a measurement. **Audio recording is not available when USB stick external memory used for storage.**



Info

To setup the instrument correctly, please refer to the chapter “[10.3 Setting audio recording parameters](#)” on page 83.



Notice!

With this function, audio recording and measurement recording are carried out simultaneously.

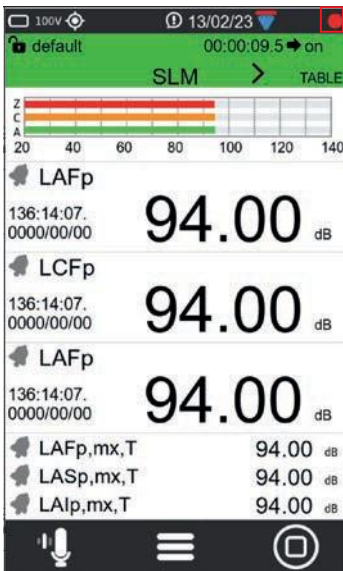
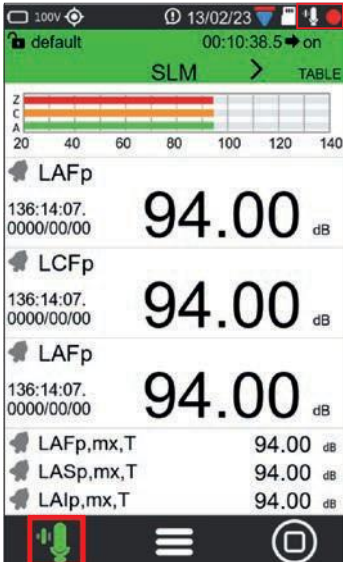
| | |
|---|---|
| <ol style="list-style-type: none"> 1 Start a measurement with recording, see chapter “9.9 Starting and stopping a measurement with datalogging” on page 77. 2 The measurement with recording is running (see the red circle recording icon in the upper right corner). 3 Tap the "audio" icon on the left to start an audio recording. |  |
| <ol style="list-style-type: none"> 4 The audio recording icon turns green when audio recording is active. The icon in the upper right corner indicates the status of audio recording. 5 Tap the "audio" icon again to stop audio recording. 6 Tap the right icon to stop recording the measurement. |  |



9.11 Manually add markers to the measurement

The MARKERS function allows specific time portions of the measurement to be highlighted with markers. The markers can be associated with specific user-customizable names such as Car, Truck, Aircraft, etc. The time portions thus highlighted are stored in the data file synchronous with the measurements and can be viewed using the NS-ENS analysis software with which its levels can be evaluated.



Notice!

This function is only available during a measurement with recording.

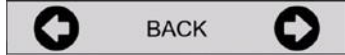
| | |
|--|---|
| <ol style="list-style-type: none"> 1 Start a measurement with recording, see chapter “9.9 Starting and stopping a measurement with datalogging” on page 77. 2 The measurement with recording is running (see the red circle recording icon in the upper right corner). 3 Tap the context menu and select MARKERS. |  |
| <ol style="list-style-type: none"> 4 Tap the left/right arrows to select the desired marker name. 5 Tap the marker name to apply the marker |  |
| <ol style="list-style-type: none"> 6 Active marker, Tap the marker name again to stop. |  |
| <ol style="list-style-type: none"> 7 Select BACK with the arrows and tap to exit the markers |  |



Info

To add and customize markers refer to the chapter “[10.5 Customizing markers](#)” on page [87](#).

10 Advanced functions

10.1 Setting the calibration parameters

The XPT800 sound level meter, with the standard transduction chain consisting of the MP800 preamplifier and model MP800 class 1 free-field microphone, is adjusted at the factory and delivered calibrated. Adjustment with a class 1 sound calibrator should be carried out periodically, normally before and after each measurement session, to ensure the validity of the measurements made by the sound level meter, as the sensitivity of the microphone and the response of the electronic circuits may vary slightly over time or may be affected by environmental conditions such as temperature, atmospheric pressure and humidity. In addition, XPT800 has an internal compensation function for environmental conditions corrections.

10.1.1 Setup

The instrument allows settings of the following parameters:

- Acoustic Field corrections;
- Windscreen and Outdoor microphone protection corrections (Shield correction);
- Emission level of sound calibrator used (Level);
- Calibration mode, manual or automatic.

To setup the calibration parameters of the instrument:

- 1 In the ICON MENU, press the **SYS-FUNC** icon to access the system and measure configuration menus.
- 2 Access the **CALIBRATION** and **SETUP** pages in succession.
- 3 Set the desired parameters.

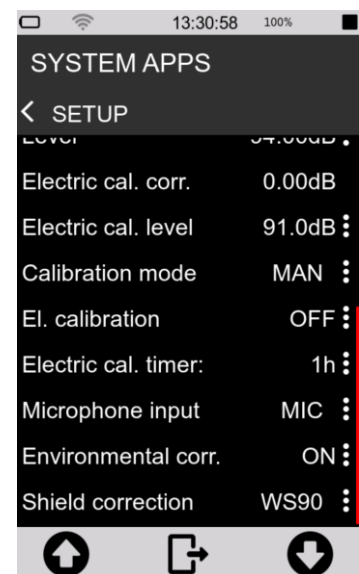

Acoustic field

With the supplied MC800 microphone, which has a frequency response optimized for "Free Field" (FF), if the parameter is set to "Free Field" (FF), correction is applied accordingly. Correction by random incidence can be enabled by setting the parameter to "Random Incidence" (RI). This setting is necessary for surveying in accordance with ANSI standards. For example, in case you choose a microphone with frequency response optimized for "diffuse field," the normal setting is "Random Incidence" (RI). You can enable correction for making free-field measurements by setting the parameter to "Free Field" (FF). This setting is necessary for measurements in accordance with IEC standards.

Correction applied for the use of WS90 or WSO windscreens (Shield correction)

Allows the sound level meter's frequency response to be corrected when either the windscreen WS90, supplied with the sound level meter, or the outdoor protection kit WSO is used. When this parameter is set to WS90, WSO the sound level meter's frequency response is corrected for the

presence of the windscreen or outdoor protection respectively.

Calibrator emission level (Level)

This is the nominal emission value of the acoustic calibrator used for adjustment of readings; it is stated by the manufacturer or obtained from calibration certificate. The instrument must be set to the same level by setting precisely the Cal_level parameter; the possible range is 90.00 ÷ 130.00 dB.

Correction applied after calibration (Correction)

The current correction level is shown after a successful calibration procedure. The correction level expressed in dB, indicates the level difference applied by the calibration algorithm from the factory calibration.

Calibration mode

The following options are available:

- Manual (MAN);
- Automatic (AUTO).

Automatic: when **Calibration Mode** is set to **AUTO**, the instrument uses detectors to automatically detect the presence of a calibration tone in the signal coming from the microphone. When the calibration tone is detected, a pop-up prompts the user to perform calibration.



Info

For a complete description of the available parameters and options, see the section “[19 Appendix B – Parameters](#)” on page 160.

10.1.2 Calibrations History

The XPT800 sound level meter, after each adjustment, stores in the "Calibration History" page the results of the calibration procedures performed with the date, time, and correction factor in dB compared to the factory calibration stored in the device.



- 1 In the ICON MENU, press the **SYS-FUNC** icon to access the system app menus.
- 2 Access the CALIBRATION and PROCEDURE pages in succession.
- 3 Access the panel "Cal. History."

| Date / Time | Corr. |
|-------------|-------|
| 00/11/22 | 0.0 |
| 11/11/22 | 2.2 |
| 22/11/22 | 2.2 |

10.2 Setting triggers

The XPT800 sound level meter has an advanced user-configurable trigger feature. Based on the input parameter setting, the trigger automatically generates "actions" useful for identifying and measuring sound events or sending an analog signal on the I/O output (trigger out) for other types of uses such as triggering external devices.

Triggering can be set through parameters such as both broadband and frequency band sound level thresholds, duration, positive or negative polarity, and pre-trigger time. For details on triggering parameters refer to the section “19 Appendix B – Parameters” on page 160.

| | |
|--|---|
| <p>1 In the ICON MENU, press the MEASURE icon to access the measurement panel.</p> |  |
| <p>2 Tap on the context menu and select EDIT APP.</p> |  |
| <p>3 Tap TRIGGER and INPUT in succession to access the TRG Input page.</p> <p>4 In the SLM panel, tap the check box to activate the input parameters for trigger/event, among those to which surplus has been previously assigned, and the desired logic (AND/OR). Parameter in grey have no exceedance activated.</p> <p>5 Press ✓ to confirm, press ✗ to cancel operation.</p> <div data-bbox="188 1794 1002 2011" style="border: 1px solid #ccc; padding: 10px; margin-top: 10px;"> <p>i Info Available parameters for triggering depend on the alarm/exceedances settings, see chapter “9.7 Set alarms on exceedances” on page 74.</p> </div> |  |

10.3 Setting audio recording parameters

It is possible to set the instrument to record an audio signal while logging acoustic values (**not available when storage device is an external USB stick**). You can, in addition, set parameters, such as the duration, bandwidth, and resolution of the audio recording.

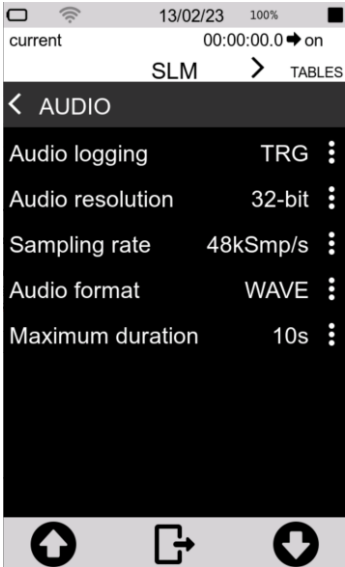
| | |
|--|---|
| <ol style="list-style-type: none"> 1 In the ICON MENU, press the MEASURE icon to access the measurement panel. 2 Tap on the context menu and successively select EDIT APP > LOG > AUDIO and the parameter to be set: <ul style="list-style-type: none"> • Audio logging (Log_audio_mode); • Audio resolution (Log_audio_res); • Sampling rate (Log_audio_samp); • Audio format • Maximum duration (Log_audio_duration). 3 Set the desired parameters. 4 Press \checkmark to confirm, press X to cancel operation. |  |
|--|---|

10.3.1 Audio recording mode

By acting on the "Log_audio_mode" parameter, audio logging can be set to:

- **disabled (OFF):** durante la registrazione dei dati non avviene nessuna registrazione audio;
- **continuous audio recording (CONT):** the audio signal is stored without interruption until the end of the measurement with datalogging.
- **event-driven audio recording (TRG):** audio recording, during a measurement with datalogging, is activated only when the set trigger condition is reached and is deactivated when the trigger condition is no longer satisfied.

Continuous audio recording

During "continuous" audio recording, the audio signal is stored without interruption until the end of the measurement.

Event-based audio recording

During "event-driven" audio recording, the audio signal is stored only when the set trigger condition is reached and is deactivated when the trigger condition is no longer met. It is possible, during the same measurement, to record another audio if the set trigger condition is met again.

To enable event-based audio recording, it is also necessary to set and activate the exceedances on the desired parameter as well, as described in the chapter "[9.7 Set alarms on exceedances](#)" on page 74.

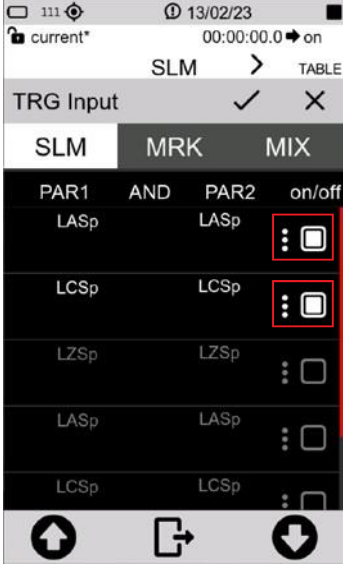
| | |
|---|---|
| <ol style="list-style-type: none"> 1 In the ICON MENU, press the MEASURE icon to access the measurement panel. 2 Tap on the context menu and select in succession EDIT APP > TRIGGER > INPUT. 3 In the SLM panel, tap the check box to activate the input parameters for trigger/event, among those to which exceedance has been previously assigned, and the desired logic (AND/OR) 4 Press <input checked="" type="checkbox"/> to confirm, press <input type="checkbox"/> to cancel operation. |  |
|---|---|

10.3.2 Audio recording resolution

It is possible to set the amplitude resolution of the audio signal. Higher resolution (e.g. 32 bits) corresponds to larger .wav files.

Parameter **Audio resolution**: you can select the resolution from the following values:

- 16 bit
- 24 bit
- 32 bit

10.3.3 Audio recording sampling frequency

The audio signal sampling frequency can be set. A higher sampling rate (e.g., 48 KSmp/s) corresponds to a higher bandwidth. The selection of the sampling frequency affects the size of the stored wav files; for example, a recording at 12KSmp/s, for the same duration, will have a lower memory occupancy than a recording at 48 KSmp/s; however, sounds over 5 KHz will not be audible in recordings made at 12 KSmp/s.

Sampling rate parameter: you can select the audio band from the following values corresponding to:

- 5k (12KSmp/s)
- 20kHz (48KSmp/s)

10.3.4 Setting a duration limit to audio recordings

Maximum duration parameter: you can select the maximum duration from the following values:

- INF (no duration set, audio recording stops when data logging is finished)
- 10s 1m; 2m; 5m; 10m; 30m; 1h (audio recording stops when the set time is reached)

10.4 Custom measurement setups

In the **APPLICATION MANAGER** section, the user is provided with a comprehensive manager of custom applications. The manager allows simple and fast operations such as selecting and loading setups or custom measurement applications for on-the-fly activation of the instrument with the desired settings for a specific measurement. The manager also allows the user to store one or more custom setups by assigning them a name and description, creating a database of setups that can be recalled as needed

For each setup, it is also possible to activate specific attributes for modification protection (Lock) or self-loading (Autoload).

10.4.1 “Current” Configuration

“Current” Is a configuration that is always available in the device and cannot be deleted (red icon )

- **Current** is the in-use configuration. You can change the settings that will be retained even after the instrument is turned off. To save local changes, it is necessary to create a custom configuration with the "SAVE AS" command.



Notice!

“Current” configuration cannot be deleted.

10.4.2 Load, Edit, Save as, Delete functions

In the **APPLICATION MANAGER** section, it is possible to load an existing configuration, edit, save a new one, and delete configurations that are no longer used.

User-created configurations have the green icon , can be edited and deleted.



Info

To load a custom configuration, please refer to the “[9.6 Load a custom configuration](#)” on page [73](#).

- 1 In the ICON MENU, press the **APPLICATION MANAGER** icon to access to the custom measurement app selection and management panel.
- 2 Select the configuration by **tapping it for at least 2 seconds** or by using the arrows and context menu commands.
- 3 The following operations are possible:
 - **CLOSE** = closes the context menu
 - **LOAD** = loads the selected configuration
 - **SAVE AS** = creates a new configuration from an existing one
 - **EDIT**: allows to activate attributes Lock and Autoload; consult section “**10.4.3 “Lock” and “Auto-Load”**” on page **87**
 - **DELETE** = cancel selected configuration, “Current” cannot be deleted

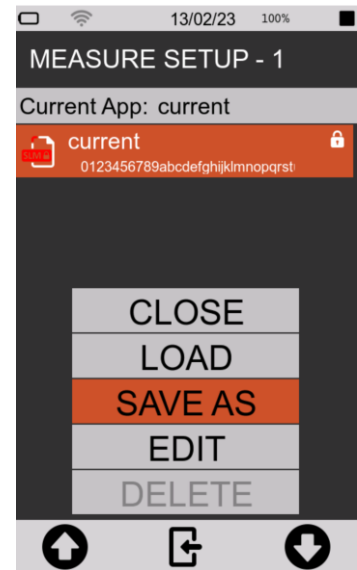

To create a **new configuration**:

- 4 After selecting SAVE AS fill in in the required fields.
- 5 Press ✓ to confirm, press ✕ to cancel operation.
- 6 The new configuration (example “configuration_1”) appears in the list, to be used it must first be loaded with the LOAD function (context menu) or directly tapping on it

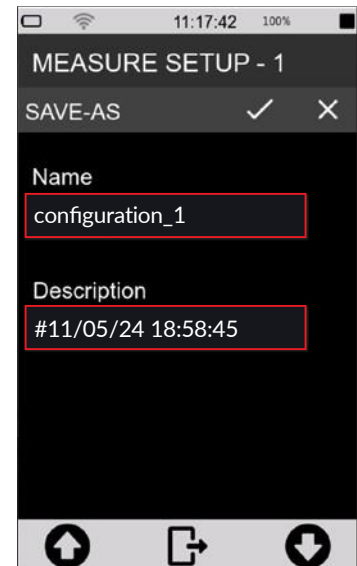

To delete a configuration created by the user:

- 7 simply tap on the configuration name for at least 2 seconds and press on DELETE in the context menu, you will be prompted to confirm, press OK.

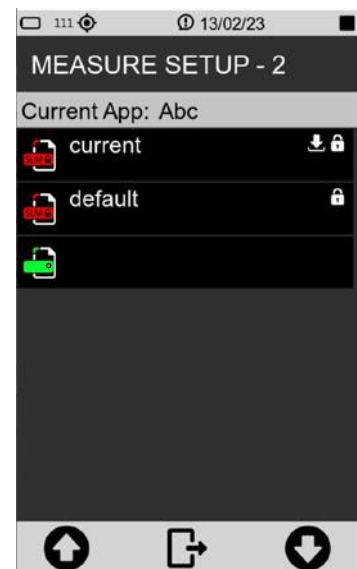

10.4.3 “Lock” and “Auto-Load” attributes

Each setup/application can be customized with *Lock* and *Auto-Load* attributes.

- **LOCK:** the application/setup is protected from overwriting
- **AUTOLOAD:** the application/setup with Auto-Load attribute activated (only one application at a time can have the attribute activated), is automatically loaded when the instrument is turned on and the related measurement screen is directly displayed

Lock and *Auto-Load* attributes can only be activated in APPLICATION MANAGER.

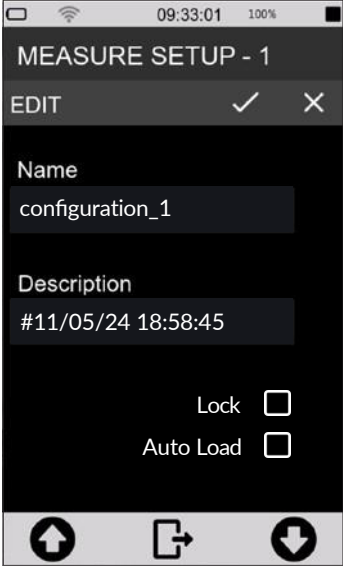
| | |
|---|--|
| <ol style="list-style-type: none"> 1 In the ICON MENU, press the APPLICATION MANAGER icon to access the custom configuration selection and management panel. 2 Select the configuration by tapping it for at least 2 seconds or by using arrows and context menu controls. 3 Tap EDIT and activate check box "Lock" or "Auto-Load" or both. |  |
|---|--|

10.5 Customizing markers

It is possible to select markers to be available during a measurement to “mark” specific events, as well as to add new ones, change their names and settings. To use markers during a measurement, see the chapter “[9.11 Manually add markers to the measurement](#)” on page 79.

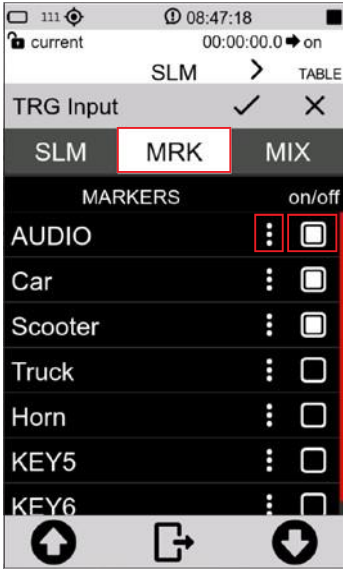
| | |
|---|---|
| <ol style="list-style-type: none"> 1 In the ICON MENU, press the MEASURE icon to access the measurement panel. 2 Tap on the context menu and select in succession EDIT APP, TRIGGER, INPUT. 3 In the MRK panel tap the check box to activate the markers to be available as input for the trigger during measurement. 4 Tap the three dots to access the customization panel for each marker to change its name 5 Press √ to confirm, press X to cancel operation. |  |
|---|---|

10.6 Continuous measurements datalogging

The XPT800 sound level meter allows the parallel storage of a set of acoustic parameters with sampling rates down to 10ms. Through the Time History, Report, Events, Globals storage groups, the user has tools at his disposal to record sound phenomena both with high temporal resolution and with integrated sampling over medium or long times, thus being able to quantify sound emissions on an hourly or daily basis, for example, or with hourly moving average integrations. In addition, the storage of time histories and calculated noise parameter values of events is also possible independently of the continuous storage of levels, saving the user, if necessary, from storing data not of interest. The Time History, Report, Events and Globals storage groups can be used simultaneously, providing the acoustician with a versatile and adaptable logging tool for every need.

10.6.1 Recording Configuration

- 1 In the ICON MENU, press the **MEASURE** icon to access the measurement panel.
- 2 Tap on the context menu and successively select EDIT APP, LOG, SETUP and the parameter to be set from the following:
 - History interval
 - Measure name (Log_name)
 - max file size (Log_file_size)
 - Log synchronization (Log_sync)
 - Sync Files (Log_sync_type)
 - Start of Reports (Report_sync)
 - Sync. backlog (Sync_files)
- 3 Set the desired options.
- 4 Press ✓ to confirm, press ✕ to cancel operation.

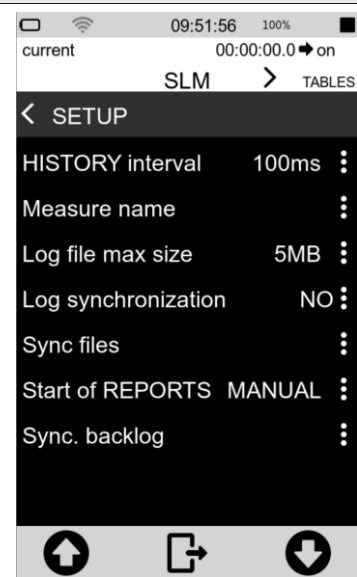

Info

You can change the same parameters from ICON MENU by tapping the SETTINGS icon and DATALOGGER > SETUP page.

History interval

Allows you to set the **sampling step**, i.e., the period between storing one sample and the next, of the acoustic parameter (or groups of acoustic parameters) selected.

Measure name (Log_name)

A user-editable prefix e.g. MYNAME_DATE_TIME can be applied to the folder name automatically generated with each log, characterized by default by the **date and time** of the measurement.

Log file max size (Log_file_size)

Limits the size of files generated during continuous recording to a user-selectable value in MB (1, 2, 5, 10, 20, 50, 100MB). Files thus generated within the folder are named, for example, as history_0001.dodl, history_0002.dodl. An automatic queuing function present in the management software and in the NS-Storage portal allows the records divided as follows, to be merged into a single trace.

Log synchronization (Log_sync)

Activates the automatic data synchronization mode on cloud. The function can be activated directly with the button  in the drop-down menu. If log_sync is on, storage support cannot be accessed via USB

Sync files (Log_sync_type)

Allows selection of file types to be synchronized to cloud among: Reports, Events, Globals, Audio.

Start of Reports (Report_sync)

If set to "CLOCK" it aligns the calculation time window of Report parameters with the nearest "round" time. For example, if Report_Step set to 1h and Report_sync set to clock, the integration time window will go from 9:00 to 10:00, 10:00 to 11:00, and so on. If Report_sync set to "MANUAL" and Report_step set to 1h, the integration window will go from the time of measurement start (e.g. 08:45:00) to the next hour (e.g. 09:45) and so on.

Sync backlog (Sync_files)

View the list of files waiting for synchronization

10.6.2 Continuous datalogging of Time History group

Continuous recording of the "time history" group includes subgroups of Instantaneous (Inst), Maximum and Minimum (Mx Mn), Integrated (Avg) and Auxiliary (Aux) parameters.

For each subgroup it is possible to select by checkbox one or more parameters that are stored with user-defined step (menu SETUP > History interval), displayed at the top of the parameter selection panel.

When for the "Time history" group, the user selects at least one parameter, the log function of the instrument, stores in the memory at least one file of the type history.dodl. A folder identified by date and time, containing *.dodl files, is created with each measurement. The folder may contain other types of files with specific functions

**Info**

For more details on the acoustic parameters (Parameter Classes) that can be stored through the "time history" group, please refer to the section "[19 Appendix B – Parameters](#)" on page 160.

10.6.3 Continuous datalogging of Reports group

The continuous recording function of the "Reports" group allows the selection of one or more acoustic parameters with storage interval independent of the storage interval set for the "time history" group. The storage interval (Report step) can be set by the user directly from the parameter selection window via the drop-down menu in EDIT APP > LOG > REPORTS.

When for the "Reports" group, the user selects at least one parameter, the log function of the instrument, stores in the memory at least one file of the type *reports.dodl*. A folder identified by date and time, containing *.dodl files, is created with each measurement. The folder may contain other types of files with specific functions.



Info

For more details on the acoustic parameters that can be stored through the "Reports" group, please refer to the section ["19 Appendix B – Parameters" on page 160](#).

10.6.4 Datalogging of Events group

The "Events" group includes parameters related to specific sound events, calculated, for example, following the activation of a trigger, for an integration time T_e (individual event duration).

When for the "Events" group, the user selects at least one parameter, the log function of the instrument, stores at least one file of the type *events.dodl*. For each measurement, a folder identified by date and time is created, containing *.dodl files. The folder may contain other types of files with specific functions.



Info

For more details on the acoustic parameters that can be stored through the "Events" group, please refer to the section ["19 Appendix B – Parameters" on page 160](#).

10.6.5 Recording Globals group

When for the "Globals" group, the user selects at least one parameter, the log function of the instrument, stores in memory at least one file of the type *Globals.dodl*. With each measurement, a folder identified by date and time is created, containing *.dodl files. The folder may contain other types of files with specific functions.

At the top of the Global parameter selection panel (EDIT APP > LOG > GLOBAL), you can select the calculation mode (Log_globals_mode) between CONT (Continuous) or DAILY (Daily). With CONT mode selected, the integration of global parameters continues after time 00:00 and ends when the measurement is stopped. With DAILY mode selected, the integration of global parameters ends at time 00:00 and resumes, after integration reset, with a new integration of data after time 00:00 and ends the next time 00:00 or upon STOP by the operator



Info

For more details on the acoustic parameters that can be stored through the "Global" group, please refer to the section ["19 Appendix B – Parameters" on page 160](#).

10.7 Playback and Generator

XPT800 has a built-in codec that allows, even while storing acoustic parameters, playback of signals through the audio output connector (Ø 3.5 mm jack socket). To play signals, select the desired play_channel. Playback is activated as soon as the measurement START button is pressed.

10.7.1 Playback management



Info



Selecting playback channel



> INTERFACES > PLAYBACK > **Channel**: allows selection of the playback channel between GEN (Generator), TRACE (File wave) or MEAS (Measurement). In OFF, the playback channel is switched off.

- By selecting **GEN** 'Generator', the instrument, when in RUN, plays through the audio output, signals created through the function:
 - > INTERFACES > GENERATOR
 - The signal to be generated can be selected from the list in
 - > INTERFACES > GENERATOR > **Files**
- By selecting **TRACE** the instrument plays wav files previously stored into folder Unit_name:\XPT800_My_serial_number\Traces*.wav.
 - The signal to be generated can be selected from the list in
 - > INTERFACES > PLAYBACK > **Tracce**
- By selecting **MEAS** 'Measure', the instrument plays back the sound detected by the microphone directly on the jack output. In this mode it is possible, depending on the setting, to reproduce the filtered microphone signal as an alternative to the broadband signal (see Filter Type)

Available parameters:

- **Repetition** enables the continuous playback of the track selected for GEN or TRACE. When set to **OFF**, the measurement started with  (Measure) or  (Measure with logging) buttons to generate the signal, is automatically interrupted after a time equal to the duration of the audio track being played back. If set to **ON**, playback and measurement are continuous.
- **Traces** (Play_trace) allows selection from the list of the track to be played (the list generated in unit_name:\XPT800_My_serial_number\Traces is updated each time the instrument is restarted).
- **Filter type** (Hearing_channel), when Play_channel set to MEAS, allows to playback unfiltered (OFF), broadband filtered (WB), or third-octave band filtered (TOCT) microphone signal.
- **WB filter** (Hearing_pond) filter, if Filter type set to WB, allows selection of the frequency weighting applied to the reproduced microphone signal between A, C, AUX (see > SOUND MEASURE > SLM > Aux ponderation).
- **Th. octave band** (Play_toct_band), if Filter Type set to TOCT, allows to select the 1/3 octave band filter applied to the reproduced microphone signal.

10.7.2 Generator management

Through the generator function, acoustic signals can be created without the use of an external generator. The user can define signal properties by adjusting parameters such as frequency, duration and amplitude. The instrument automatically creates the signals as defined and stores them in wave format in the unit_name:\XPT800_My_serial_number\Generator\ folder. Once the signals have been created, they can also be played back during measurements

Available parameters:

- **Frequency** lets you select the frequency of the signal.
- **Amplitude** allows you to select the amplitude of the generated signal.
- **Duration** allows you to set the duration of the signal (max duration 10s).
- **Files** to select the signal to be played back to jack output.



Info

Create a new signal file for generator

To create a generator signal file, proceed as follows



- > INTERFACES > GENERATOR
- Set Frequency and Amplitude
- Set the duration (max. 10s) > the file is automatically created in the folder *unit_name:\XPT800_My_serial_number\Traces*.wav* where the file name indicates the set frequency and duration
- The created file is available in the list > INTERFACES > GENERATOR > Files



Info

Playback a signal with the generator function

To generate a file via the generator function, proceed as follows:



- > INTERFACES > GENERATOR > Files
- Select the wav file to be generated
- From > PLAYBACK > **Repetition** select
YES to play the selected file continuously
NO to stop playback and measurement after a period equal to the wave file duration
- Start measurement with (Measure) or (Measure with logging) buttons

10.8 Activating the preamplifier heater



Notice!

Activation of the heater increases energy consumption and reduces autonomy.

Humidity in the air, coming into contact with cold surfaces, can generate condensation. In particular, the metal components of the transduction chain consisting of the preamplifier and microphone capsule can be affected by condensation, which can cause disturbance with the measurement and, in severe cases, damage to the transduction chain.

The heater inside the preamplifier, in conjunction with the WSO outdoor microphone protection, reduces the risk of damage to the transduction chain and ensures that measurements are not affected by high levels of humidity on the microphone capsule membrane.

- 1 In the **ICON MENU**, press the **SETTINGS** icon to access the system and measurement configuration menus.
- 2 Access pages **SOUND MEASURE > SETUP** and **Preamplifier heater**
- 3 Select the desired option (**OFF** = heater off; **ON**= heater on).
- 4 Tap ✓ to confirm, tap X to cancel

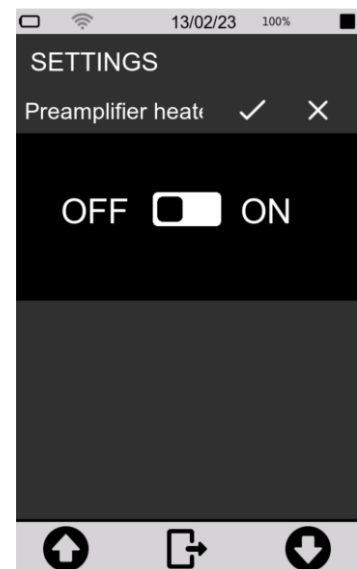

10.9 Monitor

The **XPT800** sound level meter has a monitoring program to check some hardware functions.

The following parameters are checked:

- Battery voltage;
- Battery level;
- Charge voltage
- Preamplifier temperature (Temp. measurement is disabled when sound levels are low)
- Available memory

- 1 In the **ICON MENU**, press the **SYS-INFO** icon to access the system app menus.
- 2 Access the **MONITOR** page.

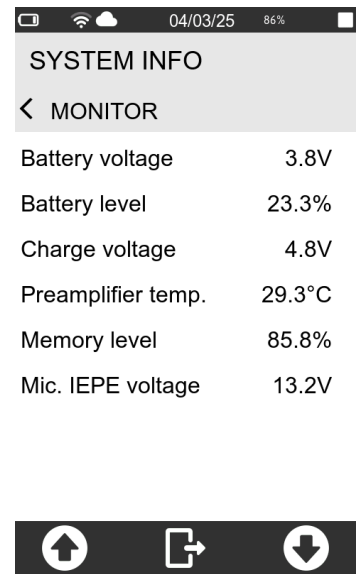

10.10 Automatic Detectors

The **XPT800** sound level meter has automatic detectors that can be used for identification, real-time display and storage, of particular sound events such as tonal or impulsive noise components of the detected noise or other types of events.

To activate an automatic detector, enter:



> DETECTORS > SETUP > Imp. & tones

| Parameter | Value | Description |
|--------------|---------------|---|
| Imp. & tones | ITA-DM-160398 | Settings according to D.M.16/03/98 |
| | ITA-custom | Settings according to D.M.16/03/98 editable |
| | ISO-1996 | Settings according to ISO-1996 |
| | ISO-custom | Settings according to ISO-1996 editable |



Info

The detectors are active in both available measurement start modes.

Only in the “Measurement with Logging” mode, the data calculated with the detectors are stored



Measurement with Logging



Measurement

Exclusively in “Measurement with Logging” mode, the detector stores the detected events in a file available in the folder Units:\XPT800_2404A00XXX\Measure

Log detectors

File Detectors.txt

XPT800_2404A00008

DETECTORS

Wed 2024/09/11 - 12:16:28

start:1726056990

| Time, | Detector, | Counter, | Description |
|--------|-----------|----------|---------------------------|
| 8000, | Tone, | 1, | 3.15kHz phon= 0.5dB K=3dB |
| 14000, | Tone, | 2, | 1kHz phon= 0.1dB K=3dB |
| 15500, | Tone, | 3, | 1kHz phon= 0.1dB K=3dB |
| 18000, | Tone, | 4, | 1kHz phon= 0.1dB K=3dB |
| 30500, | Tone, | 5, | 2kHz phon= 0.1dB K=3dB |
| 42000, | Tone, | 6, | 800Hz phon= 0.3dB K=3dB |
| 52000, | Tone, | 7, | 2kHz phon= 0.1dB K=3dB |
| 56500, | Tone, | 8, | 2.5kHz phon= 0.2dB K=3dB |
| 66500, | Tone, | 9, | 8kHz phon= 0.1dB K=3dB |
| 84500, | Tone, | 10, | 125Hz phon= 0.1dB K=6dB |
| 87000, | Tone, | 11, | 125Hz phon= 0.1dB K=6dB |

10.10.1 Tones detector according to D.M. 16 marzo 1998

Selecting the ITA-DM-160398 detector sets the instrument to detect in real time, display and record sound events with tonal and impulsive characteristics according to the requirements of the Italian standard D.M.16/03/1998.

Operation

The TONES detector captures sound level differences between adjacent bands of the minimum 1/3-octave spectrum measured with Fast time constant.

Note: the type of 1/3-octave spectrum used for calculation can be modified through the parameter *Det.spectrum tones* only if *ITA-custom* is selected in *SETUP > Imp.&tones*). If the parameter is set to ITA-DM-160398, the spectrum type used is LTOFp,min,T

The 1/3-octave bands with a dB value at least 5dB higher than the corresponding adjacent bands are identified and considered for the assessment of audibility.

Tone audibility evaluation: the dB value of the 1/3-octave band identified as previously described is used for comparison with other bands in the spectrum and to calculate the isophonic curve (ISO226) corresponding to and crossing that point. If all the remaining bands of the measured spectrum have dB values lower than the corresponding values of the previously identified isophonic curve, then the identified band is considered a tonal component (CT). In this case, the band is represented in the histogram graph of the spectrum in orange color.

Activating the detector

To activate the detector access the *Det.spectrum tones* parameter shown in the parameter list in the table below.

Note: If the detector is set to the *ITA-DM-160398* default value, the detector-specific parameters are set to their default values. Changing any of the parameters changes the mode from *ITA-DM-160398* to *ITA-custom* allowing the desired parameters to be set and used.



> DETECTORS > TONES

| Parameter | Value | Description |
|--------------------|-------------|---|
| Det.spectrum tones | OFF | Detector disabled |
| | ON | Detector active* |
| Sp. Type for tones | INST | Detector on spectrum INST |
| | MOV | Detector on spectrum MOV |
| | MOV-MAX | Detector on spectrum MOV-max |
| | MOV-MIN | Detector on spectrum MOV-min |
| | AVG | Detector on spectrum AVG |
| | MAX | Detector on spectrum MAX |
| | MIN | Detector on spectrum MIN |
| | REP | Detector on spectrum REP |
| | REP-MAX | Detector on spectrum REP-max |
| ISO226 Version | REP-MIN | Detector on spectrum REP-min |
| | 1987 | Isophonic contours version ISO226:1987 |
| | 2003 | Isophonic contours version ISO226:2003 |
| | 2023 | Isophonic contours version ISO226:2023 |

*Default values ITA-DM-160398 in bold

Graphic Output

When a Tone detector finds the presence of a Tone Component (CT) in the measured signal, the interface provides the user with the graphical and numerical information described below. If the measurement is started in the *Measurement with Logging* mode, the measured data are stored as described in [10.10 Automatic Detectors](#)

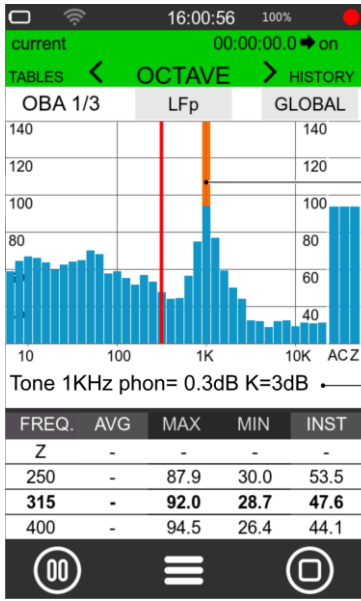
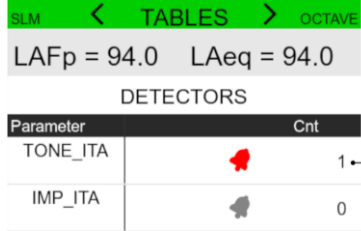
| | |
|--|--|
| <p>1</p> <p>Frequency band highlighted in orange: indicates that, for the Detector selected in the settings, the trigger condition is met (e.g. there is a CT - Tonal Component at the frequency of 1KHz)</p> |  <p>2</p> |
| <p>Detector information area: string displays</p> <ul style="list-style-type: none"> • type of detector (Tone) • frequency of detected tone • phon value in dB • correction factor K <ul style="list-style-type: none"> ○ +3dB ○ +6dB (f<200Hz period 22:00-6:00) |  <p>3</p> |

10.10.2 Tones detector according to ISO1996

Selecting ISO-1996 detector sets the instrument to detect in real time, display and record sound events with tonal and impulsive characteristics according to the requirements of the international standard ISO-1996.

Operation

The detector captures sound level differences between adjacent bands of the time-averaged spectrum in 1/3 octave bands.

Note: The type of 1/3-octave spectrum used for calculation can be changed through the *Sp.type for tones* parameter only if **ISO-custom** is selected in **SETUP > Imp.&tones**). If the parameter is set to **ISO-1996**, the type of spectrum used is AVG (LTOeq,T)

Bands of the spectrum that, at a certain instant, meet one of the following conditions are identified as tones:

- if $25\text{Hz} \leq \text{band}[i] \leq 125\text{Hz}$
 - $\text{band}[i] - \text{band}[i - 1] \geq 15$
 - $\text{band}[i] - \text{band}[i + 1] \geq 15$
- if $160\text{Hz} \leq \text{band}[i] \leq 400\text{Hz}$
 - $\text{band}[i] - \text{band}[i - 1] \geq 8$
 - $\text{band}[i] - \text{band}[i + 1] \geq 8$
- if $500\text{Hz} \leq \text{band}[i] \leq 10\text{KHz}$
 - $\text{band}[i] - \text{band}[i - 1] \geq 5$
 - $\text{band}[i] - \text{band}[i + 1] \geq 5$

Assessment of tone audibility: the dB value of the 1/3-octave band identified as previously described is used for comparison with other bands in the spectrum and to determine the value of the isophonic curve (ISO226) corresponding to and crossing that point.

Activating the detector

To activate the detector, go to the *Det. Spectrum Tones* parameter shown in the parameter list in the table below.

Note: If the detector is set to the ISO-1996 default value, the detector-specific parameters are set to their default values. Changing any of the parameters changes the mode from ISO-1996 to ISO-custom allowing you to set and use the desired parameters.



> DETECTORS > TONES

| Parameter | Value | Description |
|----------------------------|------------------------------|---|
| <i>Det. Spectrum Tones</i> | OFF | Detector disabled |
| | ON | Detector active* |
| Sp.type for tones | INST | Detector on spectrum INST |
| | MOV | Detector on spectrum MOV |
| | MOV-MAX | Detector on spectrum MOV-max |
| | MOV-MIN | Detector on spectrum MOV-min |
| | AVG | Detector on spectrum AVG |
| | MAX | Detector on spectrum MAX |
| | MIN | Detector on spectrum MIN |
| | REP | Detector on spectrum REP |
| | REP-MAX | Detector on spectrum REP-max |
| REP-MIN | Detector on spectrum REP-min | |
| ISO226 version | 1987 | Isophonic contours version ISO226:1987 |
| | 2003 | Isophonic contours version ISO226:2003 |
| | 2023 | Isophonic contours version ISO226:2023 |

*Default ISO-1996 values in bold

Graphic Output

When the detector finds the presence of a Tone in the measured signal, the interface provides the user with the graphical and numerical information described below. If the measurement is launched in the *Measurement with Logging* mode, the measured values are stored as described in [10.10 Automatic Detectors](#)

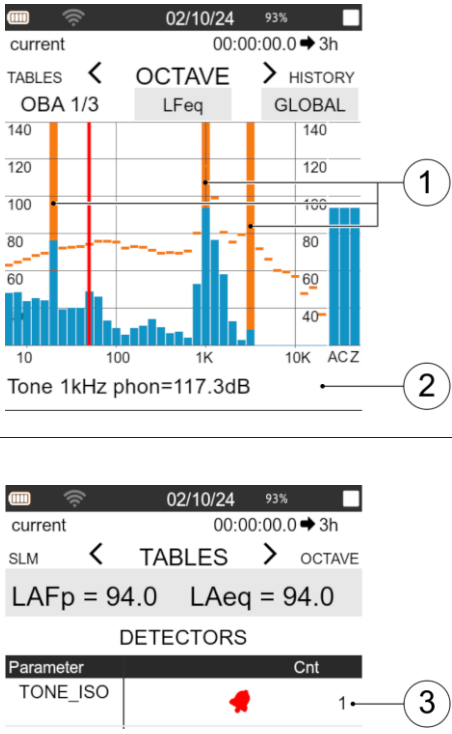
| | |
|---|--|
| <p>1 Frequency band highlighted in orange: indicates that, for the Detector selected in the settings, the trigger condition is met (e.g. 3 tones identified at 25Hz, 1KHz, 3.15KHz)</p> <p>Detector information area: string displays</p> <ul style="list-style-type: none"> • type of detector (Tone) • frequency of detected tone • phon value in dB <p>2</p> <p>Table view</p> <ul style="list-style-type: none"> • List of detectors • Cnt: number of detections in the current measurement • Detector status: <ul style="list-style-type: none"> ○ red bell: detection in progress ○ gray bell: no detection <p>3</p> |  <p>The top screenshot shows the 'OCTAVE' view with a spectrum plot. A peak at 1kHz is highlighted in orange. The bottom screenshot shows the 'TABLES' view with a table of detectors. The 'TONE_ISO' detector has a red bell icon and a count of 1.</p> |
|---|--|

Exclusively in “Measurement with Logging” mode, the detector stores the detected events in a file available in the folder Units:\XPT800_2404A00XXX\Measure

Detectors Log

File Detectors.txt

XPT800_2404A00009

DETECTORS

Tue 2024/10/02 - 21:28:37

start:1727904519

| Time, | Detector, | Counter, | Description |
|-------|-----------|----------|-------------------|
| 7000 | Tone, | 1 | 1kHz phon=117.3dB |

10.10.3 Impulses detector according to D.M. 16 marzo 1998

Selecting the ITA-DM-160398 detector sets the instrument to detect in real time, display and record sound events with tonal and impulsive properties according to the requirements of the Italian standard D.M.16/03/1998.

Operation

The IMPULSES detector monitors the instantaneous parameters LAFp, LAIp, and LAsp in parallel. If, at a given instant, the value of LAIp (max) exceeds the value of LAsp (max) by at least 6dB (default), the duration of the impulse event is determined @ -10dB from the LAFp (max) value. A duration of less than 1s on LAFp (max), determines that the event is classified as an impulse.

Activating the detector

To activate the detector, go to the *Det.Impulses* parameter shown in the parameter list in the table below.

Note: If the detector is set to the ITA-DM-160398 default value, the detector-specific parameters are set to their default values.



> DETECTORS > IMPULSES > Det. impulses

| Parameter | Value | Description |
|------------------|-----------|-----------------------------|
| Det. impulses | OFF | Detector inactive |
| | ON | Detector active |
| Impulse lev.thr. | 10 dB | Not active for detector ITA |

Graphic Output

When the detector finds the presence of a Impulse in the measured signal (CI), the interface provides the user with the graphical and numerical information described below. If the measurement is launched in the *Measurement with Logging* mode, the measured values are stored as described in **10.10 Automatic Detectors**

| <p>1</p> <p>Horizontal bar markers of detectors: if detectors are activated, the lower 3 traces of the markers, display the activations of 3 detectors whose meanings are given in the label (IMPULSES, TONES, ...). When a detector is activated, the event that generated its activation is represented as a red horizontal bar of length equivalent to the duration of the event</p> | | | | | | | |
|---|---|-----------|-----|----------|---|---------|---|
| <p>2</p> <p>Table view</p> <ul style="list-style-type: none"> List of detectors Cnt: number of detections in the current measurement Detector status: <ul style="list-style-type: none"> red bell: detection in progress gray bell: no detection | <table border="1" style="margin-top: 10px;"> <thead> <tr> <th>Parameter</th> <th>Cnt</th> </tr> </thead> <tbody> <tr> <td>TONE_ITA</td> <td>1</td> </tr> <tr> <td>IMP_ITA</td> <td>9</td> </tr> </tbody> </table> | Parameter | Cnt | TONE_ITA | 1 | IMP_ITA | 9 |
| Parameter | Cnt | | | | | | |
| TONE_ITA | 1 | | | | | | |
| IMP_ITA | 9 | | | | | | |

Exclusively in “Measurement with Logging” mode, the detector stores the detected events in a file available in the folder Units:\XPT800_2404A00XXX\Measure

10.10.4 Impulses detector according to ISO1996

Selecting ISO-1996 detector sets the instrument to detect in real time, display and record sound events with tonal and impulsive properties according to the requirements of the international standard ISO-1996.

Operation

The IMPULSES detector is based on ISO-1996-3:2022 and requires detection of the instantaneous

parameter LAFp with time base 10ms. The parameters monitored by the detector in correspondence with an impulse are as follows.:

LD: level difference, in decibels
 Ls: level at the starting point, in decibels
 Le: level at the end point, in decibels
 OR: onset rate, in decibels per second
 Ts: starting point, in seconds
 Te: end point, in seconds

In the measurement interval, pulses are identified according to the rate of onset and apparently higher level differences. For each selected pulse, Prominence P is calculated according to the Standard according to the following formula

$$P=3*\log[r]+2*\log(D)$$

r : onset rate (OR)
 D: level difference (LD)

Identification of the K_i correction for LAeq,T

The correction of the LAeq,T descriptor is calculated and applied according to the following logic

$$K_i=1,8*(P-5) \text{ if } P>5$$

$$K_i = 0 \text{ for } P \leq 5$$

Categorization of impulsive sound

Potentially impulsive sounds are classified according to K_i

Correction $K_i = 0$ at the receiver location: not impulsive
 Correction $0 < K_i \leq 5$ at the receiver location: regular impulsive
 Correction $K_i > 5$ at the receiver location: highly impulsive

Apply the adjustment to the LAeq,T level, based on the source categorization as given in ISO 1996-1, or apply the K_i adjustment directly to the assessment level.

Activating the detector



In **DETECTORS > SETUP > Imp.&tones** select the ISO-1996 reference standard

To activate the detector, access the *Det.impulses* parameter shown in the parameter list in the table below.

Note: If the detector is set to the ISO-1996 default value, the detector-specific parameters are set to their default values.



DETECTORS > IMPULSES > Det.Impulses

| Parameter | Value | Description |
|------------------|-----------|--|
| Det.Impulses | OFF | Detector inactive |
| | ON | Detector active |
| Impulse lev.thr. | 10 dB | Sets LD level difference (only if ISO-custom selected otherwise not active) |

Graphic Output

When the detector finds the presence impulsive sounds in the measured signal, the interface provides the user with the graphical and numerical information described below. If the measurement is launched in the *Measurement with Logging* mode, the measured values are stored as described in [10.10 Automatic Detectors](#)

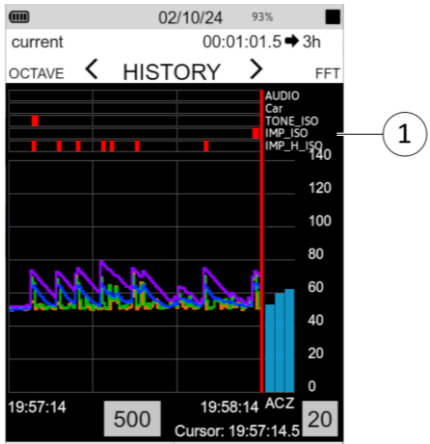
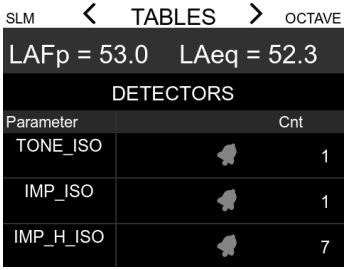
| <p>Horizontal bar markers of detectors: if detectors are activated, the lower 3 tracks of the markers, display the activations of 3 detectors whose meanings are given in the label</p> <p>1</p> <ul style="list-style-type: none"> • TONE_ISO: tone event • IMP_ISO: impulse with $0 < K_i \leq 5$ • IMP_H_ISO: impulse with $K_i > 5$ <p>When a detector is triggered the event that generated its activation is represented as a red horizontal bar of length equivalent to the duration of the event</p> |  | | | | | | | | |
|--|--|-----------|-----|----------|---|---------|---|-----------|---|
| <p>Table view</p> <ul style="list-style-type: none"> • List of detectors • Cnt: number of detections in the current measurement • Detector status: <ul style="list-style-type: none"> ○ red bell: detection in progress ○ gray bell: no detection <p>2</p> |  <table border="1"> <thead> <tr> <th>Parameter</th> <th>Cnt</th> </tr> </thead> <tbody> <tr> <td>TONE_ISO</td> <td>1</td> </tr> <tr> <td>IMP_ISO</td> <td>1</td> </tr> <tr> <td>IMP_H_ISO</td> <td>7</td> </tr> </tbody> </table> | Parameter | Cnt | TONE_ISO | 1 | IMP_ISO | 1 | IMP_H_ISO | 7 |
| Parameter | Cnt | | | | | | | | |
| TONE_ISO | 1 | | | | | | | | |
| IMP_ISO | 1 | | | | | | | | |
| IMP_H_ISO | 7 | | | | | | | | |

Exclusively in “Measurement with Logging” mode, the detector stores the detected events in a file available in the folder Units:\XPT800_2404A00XXX\Measure

Log detectors ISO-1996

XPT800_2404A00009

DETECTORS

Tue 2024/10/02 – 02:36:31

start:1727836593

| Time | Detector | Counter | Description | | | | | | |
|--------|----------|---------|--------------|-------------------|-------------------|-----------------------|---------|-----------------|--|
| 1660 | High Imp | 1 | level=67.1dB | prominence=12.0dB | correction=12.7dB | MAX_prominence=12.0dB | @ 1660 | max_corr=12.7dB | |
| 11250 | High Imp | 2 | level=68.3dB | prominence=8.5dB | correction=6.3dB | MAX_prominence=12.0dB | @ 1660 | max_corr=12.7dB | |
| 20180 | High Imp | 3 | level=67.1dB | prominence=11.1dB | correction=11.1dB | MAX_prominence=12.0dB | @ 1660 | max_corr=12.7dB | |
| 39240 | High Imp | 4 | level=65.2dB | prominence=10.2dB | correction=9.5dB | MAX_prominence=12.0dB | @ 1660 | max_corr=12.7dB | |
| 42430 | High Imp | 5 | level=67.2dB | prominence=10.0dB | correction=9.1dB | MAX_prominence=12.0dB | @ 1660 | max_corr=12.7dB | |
| 59930 | High Imp | 6 | level=65.9dB | prominence=10.9dB | correction=10.7dB | MAX_prominence=12.0dB | @ 1660 | max_corr=12.7dB | |
| 71100 | High Imp | 7 | level=74.3dB | prominence=12.7dB | correction=13.9dB | MAX_prominence=12.7dB | @ 71100 | max_corr=13.9dB | |
| 200300 | Impulse | 1 | level=71.8dB | prominence=7.2dB | correction=4.1dB | MAX_prominence=12.7dB | @ 71100 | max_corr=13.9dB | |
| 204020 | High Imp | 12 | level=66.9dB | prominence=8.0dB | correction=5.5dB | MAX_prominence=12.7dB | @ 71100 | max_corr=13.9dB | |
| 219890 | High Imp | 13 | level=67.3dB | prominence=8.0dB | correction=5.5dB | MAX_prominence=12.7dB | @ 71100 | max_corr=13.9dB | |
| 213030 | High Imp | 14 | level=74.0dB | prominence=7.8dB | correction=5.1dB | MAX_prominence=12.7dB | @ 71100 | max_corr=13.9dB | |

10.11 Spectral Analysis with Bandpass filter

The XPT800 optionally features (see 5.3.3 on page 34) of Bandpass filters for constant percentage band (CPB) spectrum analysis of the sound signal.

Constant Percentage Bandpass Filters

A constant percentage band filter is a type of filter whose bandpass frequency range (pass band) is proportional to the centre frequency. This means that the bandwidth varies as a function of the centre frequency, maintaining a constant relationship.

Relative bandwidth:

The bandwidth Δf is given by:

$$\Delta f = k \cdot f_c$$

where:

- Δf is the bandwidth.
- k is a constant factor representing the percentage of the band with respect to the centre frequency f_c .
- f_c is the centre frequency.

In the case of filters in thirds of an octave, $k \approx 23.1\%$ (equal to about 1/3 of an octave in logarithmic terms) while in the case of filters in octaves, $k \approx 70.7\%$

Spectral analysis is calculated in real time in 1/1 octave in the range 8 Hz-16 kHz or 1/3 octave in the range 6.3 Hz-20 kHz. The filters comply with class 1 according to IEC 61260-1:2014.

The calculable parameters are shown in the table below.

| Parameter | Averaging | Weighting | Bandwidth | Description |
|-----------|------------|-----------|---------------------------|--|
| LXOYp | FAST, SLOW | A, C, OFF | Octave band filters | Octave band spectrum of sound pressure level. 8Hz to 16kHz bands |
| LXOeq | LIN | A, C, OFF | Octave band filters | Octave band spectrum of the equivalent sound pressure level. 8Hz to 16kHz bands |
| LXOeqm | LIN | A, C, OFF | Octave band filters | Octave band spectrum of equivalent sound pressure level with moving integration. 8Hz to 16kHz bands |
| LXTOYp | FAST, SLOW | A, C, OFF | Third Octave band filters | Third-octave band spectrum of sound pressure level with constant FAST or SLOW. Bands from 6.3Hz to 20kHz |
| LXTOeq | LIN | A, C, OFF | Third Octave band filters | Third-octave band spectrum of the equivalent sound pressure level. Bands from 6.3Hz to 20kHz |
| LXTOeqm | LIN | A, C, OFF | Third Octave band filters | Third-octave band spectrum of the equivalent sound pressure level with moving integration. Bands from 6.3Hz to 20kHz |
| LXTOYn | FAST, SLOW | A, C, OFF | Third Octave band filters | Percentile sound pressure levels for bands in the third octave spectrum. Seven user-defined levels are calculated. |
| pLXTO | FAST, SLOW | A, C, OFF | Third Octave band filters | Statistics of sound pressure levels of the spectrum by third-octave bands. 121 classes are calculated from 1.0dB |

10.11.1 Settings

Setting the **frequency weighting** of the spectrum

SETTINGS > SOUND MEASURE > SPECTRA: spectrum.pond: **OFF, A, C**

Set the **bandwidth** (Order)

SETTINGS > SOUND MEASURE > SPECTRA: spectrum order: **1** (Octave), **3** (Third Octave)

Setting the spectrum **time constant**

SETTINGS > SOUND MEASURE > SPECTRA: Spectrum constant: **FAST, SLOW**

10.11.2 Graphic Output

To view the results of the spectrum analysis in graphical form see [8.3 Octave and Third Octave](#) on page [58](#).

To view the results of the spectrum analysis in tabular form see [8.2 TABLE](#) on page [56](#)

10.11.3 Storage of results

The XPT800 allows storage of spectrum analysis results calculated in parallel with Exp (Fast or Slow), Lin (Leq) and Moving averages. To set up datalogging of octave-band or third-octave values see [9.4 Set acoustic parameters to be stored](#) on page [69](#)

10.12 Statistics and Percentile Levels

XPT800 allows calculation of statistical parameters of both broadband and third-octave band sound levels. For a graphical display of statistics see [8.7 “Statistics” on page 64](#). For tabular values of calculated statistics see [on page 56](#)

To set the parameters for statistical calculations, go to the menu:



SETTINGS > SOUND MEASURE > STATISTICS

| Parameter | Value | Description |
|---------------------|---|--|
| Ln1 | | Set the percentile value Ln1 |
| Ln2 | | Set the percentile value Ln2 |
| Ln3 | | Set the percentile value Ln3 |
| Ln4 | Numerical input Values: from 0.1% to 99.9% | Set the percentile value Ln4 |
| Ln5 | | Set the percentile value Ln5 |
| Ln6 | | Set the percentile value Ln6 |
| Ln7 | | Set the percentile value Ln7 |
| Integration | LIN FAST SLOW | Selects the time constant of the broadband parameter used for calculation |
| Ponderation | C A AUX | Selects the frequency weighting of the broadband parameter used for calculation |
| Spectrum statistics | OFF REPORTS EVENTS GLOBALS | Select whether to calculate the spectral statistics of Reports or Events or Globals |
| Spectrum stat. int | LIN EXP | Select Linear or Exponential average for the calculation of spectral statistics |

10.13 FFT Spectral Analysis

XPT800 optionally features (see also [5.3.3 on page 34](#)) filters for *Fast Fourier Transform* (FFT) sound signal spectrum analysis.

10.13.1 Settings

For settings go to the menu:



SETTINGS > SOUND MEASURE > FFT SPECTRA

| Parameter | Value | Description | | | | | | | | | | | | | | | | | | | | | | | | | |
|-------------------|---------------------|---|------|----------------|--|--|--|-----------|------|------|------|-------|-------------|------|------|------|-------|-------------|------|------|------|-------|--------------|-------|------|------|------|
| FFT analyzer | ON | Activates the FFT analyser | | | | | | | | | | | | | | | | | | | | | | | | | |
| | OFF | Deactivates the FFT analyser | | | | | | | | | | | | | | | | | | | | | | | | | |
| FFT windowing | | Selects the type of window applied to the time samples of the signal on which the FFT is calculated. Signal windowing reduces spectral leakage effects due to truncation. The use of a window implies a compromise between: <ul style="list-style-type: none"> • Reduction of leakage (spectral dispersion) • Frequency resolution (broadens/narrows spectral peaks) | | | | | | | | | | | | | | | | | | | | | | | | | |
| | RECTANGULAR | No bevel, equivalent to no window. Excellent spectral resolution. High leakage. | | | | | | | | | | | | | | | | | | | | | | | | | |
| | TRIANGULAR | Good compromise between resolution and leakage reduction. | | | | | | | | | | | | | | | | | | | | | | | | | |
| | HANNING | Good compromise between resolution and leakage reduction. | | | | | | | | | | | | | | | | | | | | | | | | | |
| | HAMMING | Similar to Hanning, but with slightly more leakage. | | | | | | | | | | | | | | | | | | | | | | | | | |
| | BLACKMAN | Better leakage attenuation, but worse frequency resolution. | | | | | | | | | | | | | | | | | | | | | | | | | |
| | FLAT-TOP | Suitable for precise amplitude measurements. | | | | | | | | | | | | | | | | | | | | | | | | | |
| FFT averaging | LIN | Linear Average | | | | | | | | | | | | | | | | | | | | | | | | | |
| | EXP | Exponential Average | | | | | | | | | | | | | | | | | | | | | | | | | |
| FFT time constant | Numeric Input [sec] | Selects the time constant for exponential averaging | | | | | | | | | | | | | | | | | | | | | | | | | |
| FFT lines | 2000 | Select the number of spectral lines | | | | | | | | | | | | | | | | | | | | | | | | | |
| | 4000 | | | | | | | | | | | | | | | | | | | | | | | | | | |
| | 8000 | | | | | | | | | | | | | | | | | | | | | | | | | | |
| | 16000 | | | | | | | | | | | | | | | | | | | | | | | | | | |
| | 24000 | | | | | | | | | | | | | | | | | | | | | | | | | | |
| | | <table border="1"> <thead> <tr> <th></th> <th colspan="4">Spectral lines</th> </tr> <tr> <th>Span [Hz]</th> <th>2000</th> <th>4000</th> <th>8000</th> <th>16000</th> </tr> </thead> <tbody> <tr> <td>1200</td> <td>0,59</td> <td>0,29</td> <td>0,15</td> <td>0,073</td> </tr> <tr> <td>6000</td> <td>2,93</td> <td>1,47</td> <td>0,73</td> <td>0,375</td> </tr> <tr> <td>24000</td> <td>11,72</td> <td>5,86</td> <td>2,93</td> <td>1,47</td> </tr> </tbody> </table> Spectral resolutions [Hz] as a function of span and number of lines | | Spectral lines | | | | Span [Hz] | 2000 | 4000 | 8000 | 16000 | 1200 | 0,59 | 0,29 | 0,15 | 0,073 | 6000 | 2,93 | 1,47 | 0,73 | 0,375 | 24000 | 11,72 | 5,86 | 2,93 | 1,47 |
| | Spectral lines | | | | | | | | | | | | | | | | | | | | | | | | | | |
| Span [Hz] | 2000 | 4000 | 8000 | 16000 | | | | | | | | | | | | | | | | | | | | | | | |
| 1200 | 0,59 | 0,29 | 0,15 | 0,073 | | | | | | | | | | | | | | | | | | | | | | | |
| 6000 | 2,93 | 1,47 | 0,73 | 0,375 | | | | | | | | | | | | | | | | | | | | | | | |
| 24000 | 11,72 | 5,86 | 2,93 | 1,47 | | | | | | | | | | | | | | | | | | | | | | | |
| FFT span: | 1200 | Selects the span, i.e. the represented frequency range in Hz | | | | | | | | | | | | | | | | | | | | | | | | | |
| | 6000 | | | | | | | | | | | | | | | | | | | | | | | | | | |
| | 24000 | | | | | | | | | | | | | | | | | | | | | | | | | | |

10.13.2 Graphic Output

To view the results of the FFT spectrum analysis in graphical and numerical form see [8.6 "FFT" on page 62](#).

10.13.3 Storage of results

The XPT800 allows FFT spectrum analysis results to be stored.

FFT spectrum storage can be Continuous (CONT) or triggered by a Trigger (TRG) generated by exceeding a settable threshold.

Set storage type:



> DATALOGGER > FFT

| Parameter | Value | Description |
|-------------|-------|---|
| | OFF | No datalogging |
| FFT logging | CONT | Continuous Datalogging |
| | TRG | Datalogging only in the presence of a trigger |

To set the instrument for FFT storage based on a trigger (TRG), follow the steps below:

- Activate **exceedance** (see [9.7](#) on page [74](#))
- Set exceedance **thresholds**
- Set **trigger input** (see [10.2](#) on page [82](#))

Stored data:

FFT spectra data can be stored in **history** and/or **global** mode.

The **history** mode (*History FFT log* parameter) stores an FFT spectrum at each log interval. The log interval depends on the spectral resolution and takes the values 1s, 500, 200, 100ms depending on the selected spectral resolution (see table below).



> DATALOGGER > FFT

| Parameter | Value | Description |
|-----------|-------|--|
| | | Storage of instantaneous FFT spectra. Log range depends on selected spectral resolution. |

| History FFT log | INST | Resolution (lines) | Log interval (sec) |
|-----------------|------|--------------------|--------------------|
| | | 16000 | 1 |
| | | 8000 | 0.5 |
| | | 4000 | 0.2 |
| | | 2000 | 0.1 |

AVG
Linearly or exponentially averaged FFT storage. See also [10.13.1](#) parameter **FFT averaging**

- **Activate history** storage > DATALOGGER > FFT > FFT logging: CONT o TRG
- **Deactivate history** storage> DATALOGGER > FFT > FFT logging: OFF

Global mode stores an FFT spectrum whose amplitude values are relative to the entire measurement time.

- **Activate Global** Storage:



> > EDIT APP > LOG > GLOBALS

In Global tab

- click the FFT checkbox for the Avg column
- Tap the ✓ button to confirm

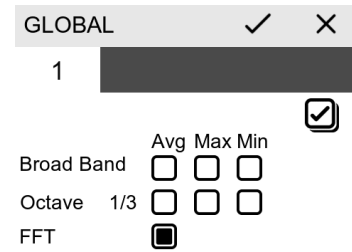

Exclusively in "Measure with Logging" mode, the XPT800 analyser stores the FFT data collected in **history** mode in the *fft.dodl* file available in the folder *Unit:\XPT800_2404A00XXX\ Measure-MyMeasure...*

If the FFT Logging mode is set to **TRG**, the instrument records in the active memory files of the type *fft0001.dodl*, *fft0002.dodl*...*fftxxx.dodl* corresponding to each trigger activation.

Exclusively in "Measurement with Logging" mode, the XPT800 analyser stores the FFT data measured in **Global** mode in the *globals.dodl* file available in the folder *Unit:\XPT800_2404A00XXXMeasure...*

To upload and view stored data on the NS-Storage portal see [11.4.2 "Data storage on Cloud"](#) on page [136](#)

10.14 Reverberation Time

Reverberation time (or RT) is the time it takes for sound to decrease by **60 decibels** from its initial level after the sound source has been interrupted. Basically, it measures how long the sound “persists” in a room before fading away completely. Reverberation time depends on the size of the room and the materials present, as reflective surfaces (such as hard, smooth walls) will prolong the sound, while absorbent surfaces (such as curtains or porous materials) will quickly reduce it. It is an important parameter in acoustics because it affects the quality of sound in a room, such as concert halls, cinemas, meeting rooms or classrooms. A reverberation time that is too long can make the sound muddy, while one that is too short can make the room sound “dry” and unnatural.

Reverberation time (RT60) was formalized by physicist Wallace Clement Sabine in 1898, and the formula that links it to the geometric and acoustic parameters of the room is known as Sabine's formula:

$$RT60 = \frac{0.161 \cdot V}{A}$$

Where:

- V is the **volume** of the room in cubic meters,
- A is the **equivalent sound absorption area**, which considers the contribution of all surfaces and objects in the room.

Physical phenomena affecting reverberation time:

Sound reflection: when a sound wave meets a surface, part of the energy is reflected and part is absorbed. Hard surfaces (e.g., concrete, glass) reflect most of the sound, while soft, porous surfaces (e.g., curtains, carpeting) absorb it.

Sound diffusion: after reflection, the sound continues to bounce around the room, diffusing more and more homogeneously. These successive bounces create the so-called **reverberant tail**, which is the residual sound that is heard even after the source has been turned off.

Sound absorption: the absorption coefficient of each material defines how much that material is capable of absorbing sound energy. For example, a coefficient equal to 0 indicates that the material is completely reflective, while a value of 1 means total absorption. Different surfaces affect different sound frequencies differently, and the distribution of absorption is critical for controlling reverberation.

Significance of reverberation time:

Acoustics of concert halls: in a theater or concert hall, an RT60 around 1.5-2 seconds is often ideal for classical music, as it allows the sound to “fill” the hall without creating audible confusion. A longer reverberation time can emphasize the warmth of the sound but is likely to compromise intelligibility.

Speech intelligibility: in dedicated speech spaces, such as classrooms or conference halls, the optimal reverberation time is shorter (usually 0.6-1 seconds), because excessive reverberation makes it difficult to distinguish words clearly, causing an “echo effect” that confuses consecutive sounds.

Reverberation time and frequency of sound:

Reverberation time is also related to **frequency**: low frequencies (bass) tend to reverberate longer than high frequencies, which are more easily absorbed by porous materials. For accurate analysis, reverberation time is measured over different frequency bands (e.g., in octave or third-octave bands).

Types of signals used for reverberation time measurement

For the measurement of T60, mainly **continuous** or **impulsive** acoustic signals are used.

Interrupted source

These signals are used for more detailed and precise analyses of the acoustic response of the room at different frequencies.

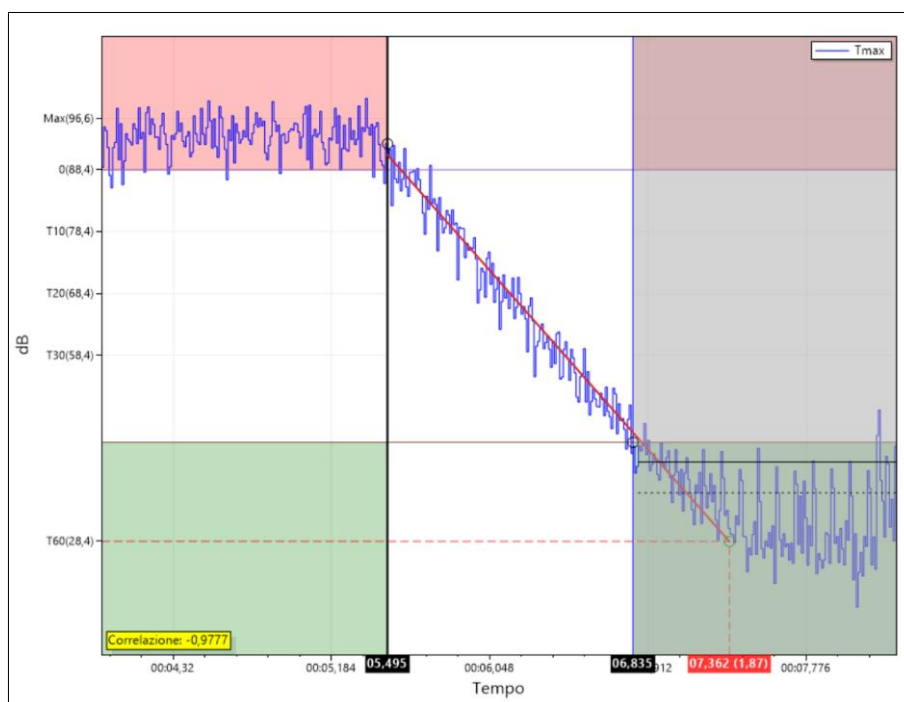

Fig. 15 – Interrupted stationary sound source decay (software NS-SIS)

White noise: a broadband signal with constant energy across all frequencies. White noise emphasizes high frequencies.

Pink noise: similar to white noise, but with a more balanced energy distribution for human perception, since the energy per octave is constant.

Sinusoidal Sweep (Sinusoidal Signal Sweep or Sine Sweep): This is a continuous signal in which the frequency varies linearly or logarithmically over time, covering a wide range of frequencies. A logarithmic sweep, for example, starts at a low frequency and gradually rises to a high frequency. This technique gives excellent results and allows good separation between distortion and noise, making it very accurate. It is used in many professional applications because of its capability to uniformly excite all frequencies.

Impulsive source

It is a very short, loud sound, like a gunshot with blanks or a balloon bursting. It is a common technique because it provides a quick and effective response, although it can be difficult to generate pulses with repetitive properties.

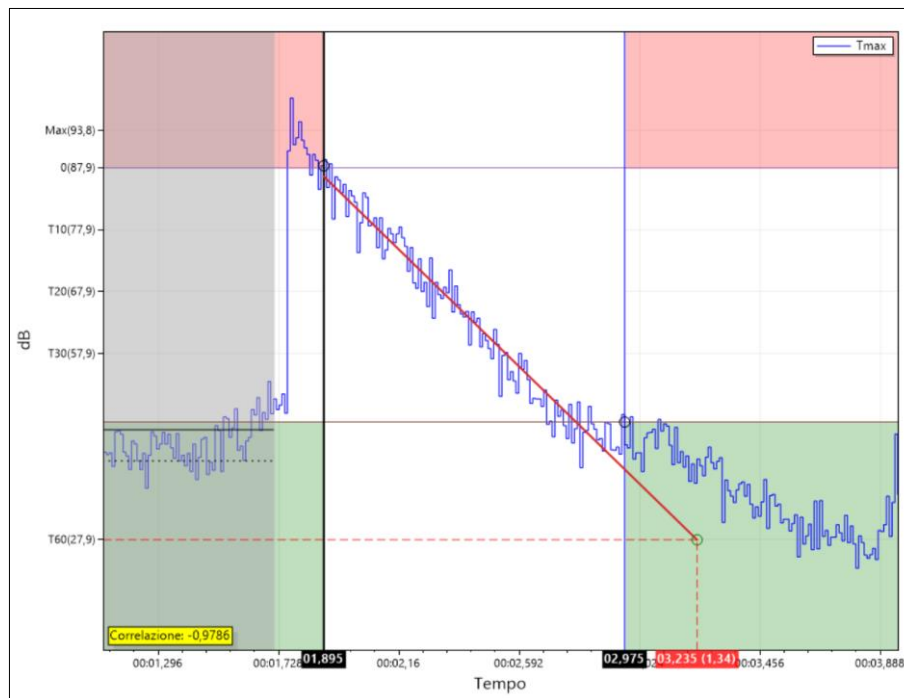

Fig. 16 – Impulsive sound decay (software NS-SIS)

Influence of background noise

When measuring RT60 (or T60) reverberation time, background noise may overlap with the sound decay if the sound energy generated is not sufficiently high. Because T60 is calculated from the 60-dB drop in sound level after the source is cut off, the presence of noise, especially toward the final tail of the decay where sound pressure levels attributable to source sound reverberation are lower and closer to ambient noise, can lead to an incorrect estimate of the decay time.

The **removal of background noise** in the calculation of T60 with an impulsive source is a crucial step in obtaining an accurate estimate of reverberation time.

Procedure for removal of background noise:

1. Measurement of impulse response:

- A sound impulse (such as a gunshot, a clapping sound, or a synthetic signal such as a burst or sine sweep) is generated and the **impulse response** of the room is recorded. This recording contains both sound decay and background noise.

2. Time window selection:

- After the impulse, **sound decay** is recorded. The background noise is most visible in the tail of the signal, when the impulse sound is very low or almost none. A time window of the signal is selected where the impulsive sound is clearly present, but the gradually mixing background noise is also taken into account.

3. Subtraction of background noise:

- A common technique for removing background noise is noise subtraction using a portion of the signal that contains only the background noise (i.e., a time interval before the impulse or after the full decay of the impulsive sound).

- The noise floor is estimated as a statistical average and is subtracted from the decay signal. This is particularly useful in low and high frequencies where the noise floor tends to overlap with the impulsive signal.
4. **Application of Schröder's integral:**
- After removing the background noise, the Schröder integral is applied to the “clean” signal. This step involves calculating the decreasing cumulative energy of the signal to determine the point at which the energy drops by 60 dB.
 - If the noise is not removed, the tail of the Schröder integral might be disturbed, leading to an incorrect estimate of the reverberation time.
5. **Working in frequency domain:**
- Background noise may sometimes be specific to certain frequency bands. Applying band-pass filters to isolate the noise and remove it before calculating T60 can improve accuracy.
 - After filtering out the noise, T60 is calculated separately for each frequency band. This method is known as **octave band or third octave bands T60**.
6. **Linear Fitting (Energy Decay Method):**
- To avoid noise in the tail of the decay, a common technique is to limit the time window for fitting the energy decay curve. Instead of considering the entire decay down to the noise level, fitting a portion of the decay (e.g., -5 dB to -35 dB) is done to avoid noise contaminating the final part of the measurement.
 - A **linear regression** is applied on the sound decay, using only the part of the signal above the noise level.

10.14.1 RT60 settings

Reverberation Time Detector

The reverberation detector automatically detects decays and calculates the T60s and related control parameters (absolute value of correlation and linearity) for each octave band and third octave band according to the following settings. The parameters are calculated according to ISO3382-2:2008.



> DETECTORS > REVERBERATION

| Parameter | Value | Description |
|-------------------|-------------|---|
| Det.reverberation | ON | Activates automatic detector T60 |
| | OFF | Disable automatic detector T60 |
| Rev.trigger band | {63Hz-8KHz} | Selects the octave band filter used to detect reverberation trigger conditions |
| Rev.corr. filter | {0.00-0.99} | Filter on allowed correlation value (absolute value) on selected "Rev.trigger band": values close to 1 filter more and signals with bad decays may not be recognized as decays; values close to 0 allow more decays to be recognized. |
| Rev. Auto STOP | ON | The measurement is stopped automatically as soon as at least one T60 is calculated |
| | OFF | The measurement continues after the calculation of a T60. The detector is waiting for a new trigger |
| Rev.corr.thr. | {0.00-0.99} | Threshold on the allowed correlation absolute value (on T_{Best}) for T60 calculation. The detector displays, at the bottom of the histogram graph, a green rectangle at each band having correlation absolute value included in the allowed range. |
| Rev.lin.thr. | {5-1000} | Threshold on the linearity value (on T_{Best}) allowed for T60 calculation. The detector displays, at the bottom of the histogram graph, a green rectangle at each band with linearity value included in the allowed range. |
| Rev.noise corr. | ON | Applies Correction with background noise subtraction |
| | OFF | No Background noise correction |

Setting up data logs and tags

T60 values calculated upon activation of the reverberation detector, decay traces, and associated measurement identification tags are stored only if the START of the measurement is done in the "Measurement with Logging" mode.

Suggested storage parameters



> DATALOGGER > SETUP

| Parameter | Value | Description |
|-----------------|-------|---|
| History Interv. | 10ms | Sampling interval history decay |
| Measure tag | EMT | Set the measure tag to REV (Reverberation). <i>Entered tag is stored in the data and automatically identified in NS-SIS data analysis software</i> <i>Parameter also editable directly from the OCTAVE measurement screen</i> |
| | REC | |
| | BKG | |
| | REV | |
| | TAP | |

| | | |
|--------------------|-------|---|
| Measure position | {num} | Allows entering a tag corresponding to the measurement position number. <i>Entered tag is stored in the data and automatically identified in NS-SIS data analysis software</i> <i>Parameter also editable directly from the OCTAVE measurement screen</i> |
| Position auto-incr | ON | Tag corresponding to the measurement position identification number is automatically increased at each measurement |
| | OFF | Tag corresponding to the measurement position identification number is not increased |



> SOUND MEASURE > SPECTRA

| Parameter | Value | Description |
|-----------------|-------------|---|
| Source position | A, B, C.... | Inserts a tag indicating the sound source position in the room. <i>Entered tag is stored in the data and automatically identified in NS-SIS data analysis software</i> <i>Parameter also editable directly from the OCTAVE measurement screen</i> |

Setting the storage parameters

The “raw” data of the 10-ms decays traces used for the T60 calculation can be stored for later import and processing in the data analysis software NS-SIS “Sound Insulation Studio”.

>
≡
> EDIT APP > LOG > TIME HISTORY

Tap the check box to select the parameters to be logged (suggested).

Info

The log interval (step) setting can be found on **EDIT APP > LOG > SETUP.**

TIME HISTORY
✓
✕

| Inst | Mx | Mn | Avg | Aux |
|----------|-------------------------------------|---|-------------------------------|-------------------------------------|
| Step | 10ms | | | <input checked="" type="checkbox"/> |
| LXYp | F <input type="checkbox"/> | A <input type="checkbox"/> | C <input type="checkbox"/> | Z <input type="checkbox"/> |
| | S <input type="checkbox"/> | | | |
| | I <input type="checkbox"/> | | | |
| LXpk | <input type="checkbox"/> | <input type="checkbox"/> | <input type="checkbox"/> | |
| LXeq | <input checked="" type="checkbox"/> | <input type="checkbox"/> | <input type="checkbox"/> | |
| LXleq | <input type="checkbox"/> | <input type="checkbox"/> | <input type="checkbox"/> | |
| 1/3 LTOp | F <input type="checkbox"/> | Leq <input checked="" type="checkbox"/> | LUFp <input type="checkbox"/> | LUeq <input type="checkbox"/> |

For details on log setting refer to [9.4 “Set acoustic parameters to be stored”](#) on pg.69

Page 114 of 180

10.14.2 RT60 measurement



Info

Reverberation detector is active in both available measurements start modes.

Only in the “Measurement with Logging” mode, the data calculated with the detectors are stored



Measurement with Logging



Measurement

Measuring T60 (see also “RT60 settings” on pg.113)

- Move to the OCTAVE screen
- Tap to set the measurement TAG
 1. Type: REV
 2. Measurement position
 3. Sound source position

Auto Incr. OFF/ON: if set to ON, the counter “Measurement position,” increments the tag value each time a new measurement start is performed.

- Start the measurement
 - Left icon: start measurement without logging
 - Right icon: start measurement with logging (Log)
- Run signal generation (start and interruption phases) and wait for detector trigger and calculation results
 - Note: if Auto-STOP parameter is ON, the measurement automatically stops after T60 computation
- T60 calculation results
 - T60 value at the reference frequency and **linearity** are shown below the graph along with the sequential number
 - In the lower section of the histogram, a green rectangle at the frequency band indicates that the T60 for that band has **correlation** and **linearity** values according to the acceptance filter settings (see also p.112)
- To take a new measurement, repeat steps a) > e)

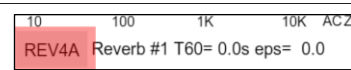
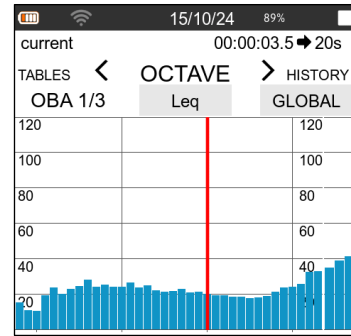

TAG ✓ ✕

Auto Incr.: OFF ON

| | | | |
|-----|---|---|---|
| EMT | | | |
| REC | | | |
| BKG | | | |
| REV | 1 | A | ② |
| TAP | 2 | B | |
| | 3 | C | |
| | 4 | D | |

① → (points to REV) (points to 1) (points to A)

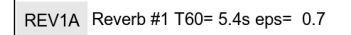
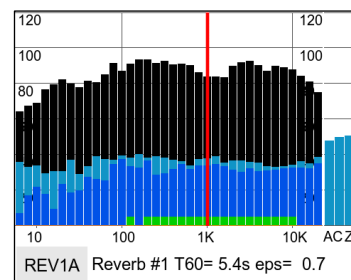

10.14.3 Graphic Output

The reverberation detector gives graphic feedbacks in the Octave, History and Table screens..

OCTAVE

- If the detector has found a suitable decay, T60 values are calculated for each frequency band. If calculated value for a given band is within the acceptance range set in “**RT60 settings**” on [pag.113](#), a green rectangle is displayed at the specific band indicating that the value is within the acceptance limits.
- Reverb # num: indicates the number of T60 computations following a trigger. The counter resets to zero each time the measurement is started. Before the # character there may be an indication:
 - **IMP** impulse response
 - **SRC** interrupted stationary source
- T60=xx[s] gives the value of T60 calculated in the selected reference octave band for the reverberation trigger
- eps= shows the decay linearity value calculated in the selected reference octave band for the reverberation trigger

1

Button to open the **Reverberation Graph**

- **T60 histogram:** displays T60 values as a function of octave or third octave bands.
 - Vertical cursor: allows selection of the decay curve to be displayed in the bottom graph
- **Decay graph:** displays the decay curve (orange) for the specific frequency selected and the calculated regression line (green)
- **Values Table:**
 - **Freq:** frequency selected with the cursor
 - **T:** reverberation time T60
 - **R:** correlation coefficient
 - **L:** curve linearity index
- **Dynamic selection:**
 - **T20:** T60 calculated on 20dB dynamics
 - **T-Best:** T60 calculated on best dynamics
- **Depth decay graph:** allows to change the zoom of the time axis (1/4, 1, 4)

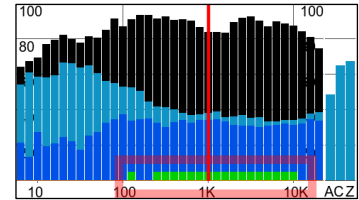

REV2A Reverb #1 T60= 2.9s eps= 0.6

REV2A Reverb #1 T60= 2.9s eps= 0.6

REV2A Reverb #1 T60= 2.9s eps= 0.6

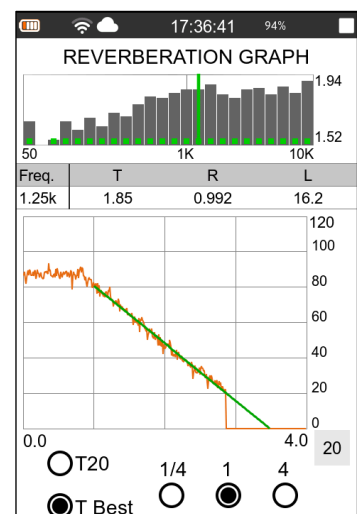

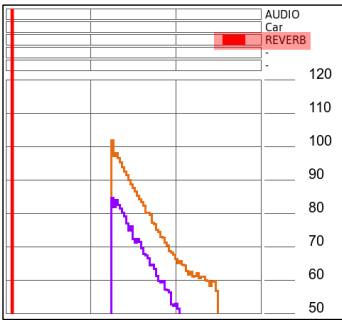
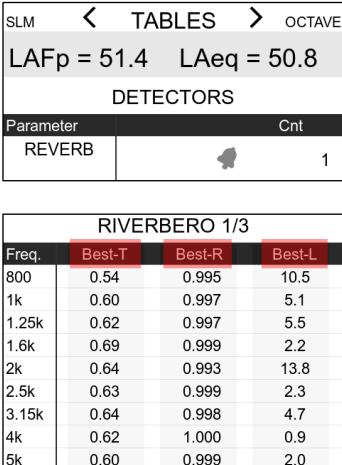
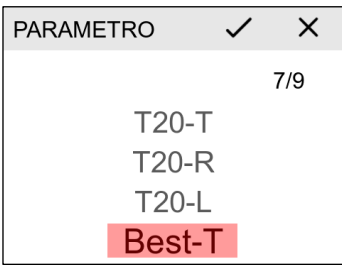
| <ul style="list-style-type: none"> Vertical scale divisions: allows the amplitude axis to be set in 1, 2, 5, 10, 20 dB divisions | | | | | | | | | | | | | | | | | | | | | | | | | | | | | | | | | | | | | | | | | | | | | |
|--|--|-----------|--------|--------|---|-------|--------|--------|--------|-----|------|-------|------|----|------|-------|-----|-------|------|-------|-----|------|------|-------|-----|----|------|-------|------|------|------|-------|-----|-------|------|-------|-----|----|------|-------|-----|----|------|-------|-----|
| <p>HISTORY</p> <p>2</p> <ul style="list-style-type: none"> If the detector has found a suitable sound decay, a red marker at the REVERB label indicates the start of the T60 calculation. If the marker does not start even in the presence of a sound decay, check the detector parameters on page 112 |  | | | | | | | | | | | | | | | | | | | | | | | | | | | | | | | | | | | | | | | | | | | | |
| <p>TABLES</p> <ul style="list-style-type: none"> Detectors The table shows the calculated T60 count following trigger activation Riverbero The table shows, for each 1/1 or 1/3 oct., the calculated values of three selectable parameters T: T60 R: correlation (given as absolute value) L: linearity <p>3</p> |  <table border="1"> <thead> <tr> <th>Parameter</th> <th>Cnt</th> </tr> </thead> <tbody> <tr> <td>REVERB</td> <td>1</td> </tr> </tbody> </table> <table border="1"> <thead> <tr> <th>Freq.</th> <th>Best-T</th> <th>Best-R</th> <th>Best-L</th> </tr> </thead> <tbody> <tr><td>800</td><td>0.54</td><td>0.995</td><td>10.5</td></tr> <tr><td>1k</td><td>0.60</td><td>0.997</td><td>5.1</td></tr> <tr><td>1.25k</td><td>0.62</td><td>0.997</td><td>5.5</td></tr> <tr><td>1.6k</td><td>0.69</td><td>0.999</td><td>2.2</td></tr> <tr><td>2k</td><td>0.64</td><td>0.993</td><td>13.8</td></tr> <tr><td>2.5k</td><td>0.63</td><td>0.999</td><td>2.3</td></tr> <tr><td>3.15k</td><td>0.64</td><td>0.998</td><td>4.7</td></tr> <tr><td>4k</td><td>0.62</td><td>1.000</td><td>0.9</td></tr> <tr><td>5k</td><td>0.60</td><td>0.999</td><td>2.0</td></tr> </tbody> </table> | Parameter | Cnt | REVERB | 1 | Freq. | Best-T | Best-R | Best-L | 800 | 0.54 | 0.995 | 10.5 | 1k | 0.60 | 0.997 | 5.1 | 1.25k | 0.62 | 0.997 | 5.5 | 1.6k | 0.69 | 0.999 | 2.2 | 2k | 0.64 | 0.993 | 13.8 | 2.5k | 0.63 | 0.999 | 2.3 | 3.15k | 0.64 | 0.998 | 4.7 | 4k | 0.62 | 1.000 | 0.9 | 5k | 0.60 | 0.999 | 2.0 |
| Parameter | Cnt | | | | | | | | | | | | | | | | | | | | | | | | | | | | | | | | | | | | | | | | | | | | |
| REVERB | 1 | | | | | | | | | | | | | | | | | | | | | | | | | | | | | | | | | | | | | | | | | | | | |
| Freq. | Best-T | Best-R | Best-L | | | | | | | | | | | | | | | | | | | | | | | | | | | | | | | | | | | | | | | | | | |
| 800 | 0.54 | 0.995 | 10.5 | | | | | | | | | | | | | | | | | | | | | | | | | | | | | | | | | | | | | | | | | | |
| 1k | 0.60 | 0.997 | 5.1 | | | | | | | | | | | | | | | | | | | | | | | | | | | | | | | | | | | | | | | | | | |
| 1.25k | 0.62 | 0.997 | 5.5 | | | | | | | | | | | | | | | | | | | | | | | | | | | | | | | | | | | | | | | | | | |
| 1.6k | 0.69 | 0.999 | 2.2 | | | | | | | | | | | | | | | | | | | | | | | | | | | | | | | | | | | | | | | | | | |
| 2k | 0.64 | 0.993 | 13.8 | | | | | | | | | | | | | | | | | | | | | | | | | | | | | | | | | | | | | | | | | | |
| 2.5k | 0.63 | 0.999 | 2.3 | | | | | | | | | | | | | | | | | | | | | | | | | | | | | | | | | | | | | | | | | | |
| 3.15k | 0.64 | 0.998 | 4.7 | | | | | | | | | | | | | | | | | | | | | | | | | | | | | | | | | | | | | | | | | | |
| 4k | 0.62 | 1.000 | 0.9 | | | | | | | | | | | | | | | | | | | | | | | | | | | | | | | | | | | | | | | | | | |
| 5k | 0.60 | 0.999 | 2.0 | | | | | | | | | | | | | | | | | | | | | | | | | | | | | | | | | | | | | | | | | | |
| <ul style="list-style-type: none"> Parameters selector (tap on the column title to access the selection panel) <ol style="list-style-type: none"> EDT-T: <i>Early Decay Time</i> T60 EDT-R: correlation <i>Early Decay Time</i> EDT-L: linearity <i>Early Decay Time</i> T20-T: T60 computed on dynamic -5/-25dB T20-R: correlation computed on dynamic -5/-25dB T20-L: linearity computed on dynamic -5/-25dB Best-T: T60 computed on Best dynamic Best-R: correlation computed on Best dynamic Best-L: linearity computed on Best dynamic |  | | | | | | | | | | | | | | | | | | | | | | | | | | | | | | | | | | | | | | | | | | | | |

10.14.4 Storage of Results

Detector

Only in “Measurement with Logging” mode, the detector stores the events found in the *detectors.txt* file available in Unit:\XPT800_2404A00XXX\Measure\MyMeasure...

XPT800_2404A00009

DETECTORS

Thu 2024/10/17 - 16:30:09

start:1729182611

| Time, | Detector, | Counter, | Description |
|-------|-----------|----------|--------------------|
| 6840 | Reverb, | #1 | T60= 2.9s eps= 0.6 |
| 7560 | Reverb, | #2 | T60= 2.9s eps= 0.5 |
| 4860 | Reverb, | #3 | T60= 2.9s eps= 0.6 |
| 13400 | Reverb, | #4 | T60= 2.9s eps= 0.5 |

Reverberation

Only in “Measurement with Logging” mode, the detector stores the events found in the *Reverberations.txt* file available in Unit:\XPT800_2404A00XXX\Measure\MyMeasure... In addition to the calculation results, the file contains additional information previously set, such as the instrument sn and measurement tags (measurement type like REV and measurement and source positions).

XPT800_2404A00009

REVERBERATIONS

Mon 2024/10/21 - 14:39:32

TAG:REV

TAG_POSITION:5

| Time | Type | TAG | MEAS_POS | SOURCE_POS | T20_TOCT_50Hz | T20_TOCT_63Hz | T20_TOCT_80Hz | T20_TOCT_100Hz | ... |
|-------|----------|-----|----------|------------|---------------|---------------|---------------|----------------|-----|
| 8610 | IMP_RESP | REV | 5 | A | 0.00 | 4.70 | 1.27 | 0.88 | ... |
| 10650 | IMP_RESP | REV | 5 | A | 2.33 | 0.85 | 1.31 | 0.90 | ... |
| 12800 | IMP_RESP | REV | 5 | A | 2.25 | 1.90 | 1.31 | 0.90 | ... |

History

If the measurement is carried out in the “Measurement with Logging” mode, and the data logging has been set up, the time history data of the decays are stored in a history.dodl file at the path Unit:\XPT800_2404A00XXX\Measure\MyMeasure... for any post analysis with the NS-SIS module.

For details on setting up the log see [9.4 “Set acoustic parameters to be stored” on pag.69](#)

10.15 Room Criteria

Room Criteria are standard indices used to evaluate noise levels in confined spaces such as offices, conference rooms, theaters and other spaces. These ratings help determine acoustic comfort and design rooms with specific acoustic requirements.

10.15.1 NC (Noise Criteria)

Description:

NC is an index developed to assess the background noise level in an enclosed environment. It is based on standard curves representing acceptable sound pressure levels in frequency bands from 16 Hz to 8000 Hz.

Objective:

Determine whether background noise is appropriate for a particular space use.

Characteristics:

NC is sensitive to noise levels in high frequencies, which affect acoustic comfort. Commonly used for HVAC (heating, ventilation, and air conditioning) system design.

Rating qualifiers are as follows:

- PSD: ANSI 12.2 Possible Serious Dissatisfaction
- LSD: ANSI 12.2 Likely Serious Dissatisfaction

Typical values:

- NC 20-30: Very quiet spaces (recording studios, bedrooms).
- NC 30-40: Offices and residential spaces.
- NC 40-50: Commercial or industrial spaces.

10.15.2 NR (Noise Rating)

Description:

The NR index was developed by the International Organization for Standardization (ISO) to classify noise levels in indoor spaces. Like the NC, NR curves represent acceptable levels of noise in frequency bands, but with a greater emphasis on the international context.

Objective:

Standardize noise assessment globally.

Characteristics:

NR curves cover bands from 31.5 Hz to 8000 Hz.

Commonly used to compare and specify acceptable noise levels in buildings and confined spaces.

Typical values:

- NR 60÷70: Workshops
- NR 50÷55: Mechanized offices
- NR 40÷50: Gyms, swimming pools
- NR 35÷45: Restaurants, bars, cafeterias
- NR 30÷40: Private offices, libraries, courtrooms
- NR 25÷35: Cinemas, hospitals, churches, small conference rooms
- NR 20÷30: Classrooms, television studios, large conference rooms
- NR 20÷25: Concert halls, theaters
- NR 10÷20: Diagnostic clinics, audiometric booths

10.15.3 RNC (Room Noise Criteria)

Description:

RNC is an update of the NC index developed by the American Society of Heating, Refrigerating and Air-Conditioning Engineers (ASHRAE) to address some of the limitations of the NC system, especially with regard to low-frequency noise

Objective:

Provide a better assessment of background noise generated by HVAC systems, with a focus on low-frequency noise.

Characteristics:

Integrates an analysis method that considers the fluctuation of noise over time.
RNC curves are used to evaluate noise in octave bands from 16 Hz to 8000 Hz.

Application:

Design and evaluation of acoustic comfort in environments such as offices, meeting rooms, classrooms.

10.15.4 RC (Room Criteria)

Description:

The RC index was introduced to provide a more detailed assessment of acoustic comfort in relation to background noise. It focuses not only on the intensity of the noise, but also on its subjective characteristics (e.g., whether the noise is “roaring” or “hissing”).

Objective:

Determine whether the background noise is neutral, roaring (low frequency noise) or hissing (high frequency noise).

Characteristics:

RC curves cover frequency bands from 16 Hz to 8000 Hz.

Provides an indication of the “type” of noise, labelling it as **neutral**, **roaring** or **hissing**.

Rating qualifiers are as follows:

- LF average energy deviation between spectrum (16,31.5,63Hz bands) and RC reference curve
- MF average energy deviation between spectrum (125,250,500Hz bands) and RC reference curve
- HF average energy deviation between spectrum (1,2,4KHz bands) and RC reference curve
- QAI Quality Assurance Index is a quantitative measure of spectral imbalance. is the difference between the highest and lowest energy-average spectral deviations.
 - If QAI < 5 dB and L16(Hz)<65, L31.5<65 spectrum is designated **neutral** (N) and acceptable
 - If QAI>5 dB, spectrum is designated LF, MF, or HF based on highest value of three
 - For 5 < QAI <10 dB spectrum is marginally acceptable (MA)
 - For QAI > 10 dB, spectrum is considered objectionable (OBJ)
 - If L16>65 or L31.5>65 spectrum is designated LFVb (Moderate degree of Low Frequency Vibration): Indicates an assessment of the balance or weighting of low-frequency noise against the rest of the sound spectrum.
 - If L16>75 or L31.5>75 spectrum is designated LFVa (Noticeable degree of Low Frequency Vibration): Indicates a possible presence of vibration or “rumble” (**roaring** noise) occurring in the low frequencies (usually below 250 Hz)

Applications:

HVAC and building design.

Typical values:



- RC 20-25: Very quiet environments.
- RC 30-35: Offices and workspaces.
- RC > 40: Noisy commercial or industrial spaces.

**Notice!**

This function is only available if octave spectral analysis activated on XPT80X device and OF9 option activated

10.15.5 Measurement

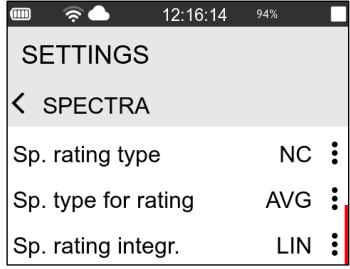
To perform a Room Criteria measurement proceed as follows:

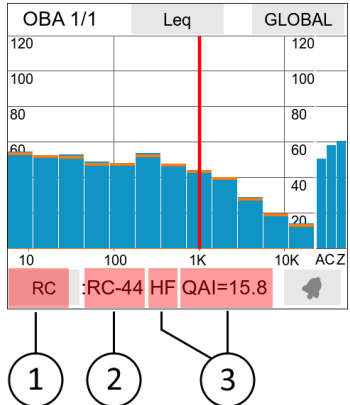
| | |
|---|---|
| <p>1 On SETTINGS > SOUND MEASURE > SPECTRA set:</p> <ul style="list-style-type: none"> • Spectrum order: 1 • Spectrum rating type: NC, RNC, NR, RC • Spectrum type for rating: INST, MOV, AVG, MAX, MIN • Spectrum rating integration.: LIN or EXP • Rating start freq. 16/31.5 Hz |  |
| <p>2 From ICON MENU tap on </p> <p>3 Select OCTAVE view</p> <p>4 Tap to select required index (1)</p> <p>5 Activate measurement</p> <p>6 Index value reading (2) and, depending on the selected index, rating qualifiers (3) related to noise characteristics. See also 10.15.4 RC (Room Criteria) on page 120</p> |  |

10.16 STI/STIPA

Speech intelligibility: this term refers to the percentage of words understood by a listener out of the total number of words spoken by a speaker during a verbal communication or reproduced by a speech reproduction system.

The **STI** (Speech Transmission Index) and **STIPA** (Speech Transmission Index for Public Address systems) indices, described in the IEC 60268-16 standard, are metrics used to assess the **quality of speech intelligibility** in an environment. They are essential in environments such as airports, stations, stadiums, conference halls and public announcement systems.

The indices used to quantify the quality of speech intelligibility are a function of:

Signal level of verbal communication L_s

- Acoustic characteristics of the voice
- Speaker - listener distance

Ambient noise level L_n

- Characterisation of room background noise and noise source-listener distance

Reverberation

- Sound absorption characteristics of the room

STIPA (Speech Transmission Index for Public Address systems)

The STIPA calculation uses as a **test signal**, filtered and modulated with 2 modulation frequencies for each octave. The index analyses how these reach the listener after being distorted in the environment. The STIPA index is based on the calculation of the **Modulation Transfer Function $m_{f,F}$** which gives a numerical value to the reduction of signal modulation in the path between the speaker and the listener within the environment.

Test signal: is pink noise, filtered for octave bands from 125Hz to 8kHz, with **sinusoidal amplitude modulations** at different frequencies. Modulation simulates the human voice and its amplitude variations. Signal modulation frequencies f_m : n² simultaneous for each octave band for a total of 14 modulation frequencies

Table 1 - Modulation frequencies

| Octave bands [Hz] | 125 | 250 | 500 | 1k | 2k | 4k | 8k |
|--|------|------|------|------|------|------|------|
| First modulation frequency f_m [Hz] | 1.60 | 1.00 | 0.63 | 2.00 | 1.25 | 0.80 | 2.50 |
| Second modulation frequency f_m [Hz] | 8.00 | 5.00 | 3.15 | 10.0 | 6.25 | 4.00 | 12.5 |

STIPA is a simplified version of the **STI** index and is developed to be faster to calculate, with a measurement time of approximately 18-20s. The STIPA method is recommended for evaluating:

- Alarm systems (VAS – Voice Alarm System)
- Distribution sound systems (PA - Public Address)
- Fast speech intelligibility checks in public environments

It is validated for male voice only and includes:

Direct Measures:

In order to simulate the human voice by reproducing the test signal described above, a suitable transducer can be used that simulates not only the spectral and amplitude characteristics but also the directivity of the speaker's head, such as a small, high-quality, single-source loudspeaker (cone diameter not exceeding 100 mm).

Test signal spectra are specified for average octave band levels. The specified band levels are normalised to an A-weighted level of 0 dB to allow scaling of the A-weighted broadband level of the emitted signal.

| Octave bands [Hz] | 125 | 250 | 500 | 1k | 2k | 4k | 8k | A-weighted |
|-------------------|-----|-----|------|------|-------|-------|-------|------------|
| Male voice [dB] | 2.9 | 2.9 | -0.8 | -6.8 | -12.8 | -18.8 | -24.8 | 0.0 |

10.16.1 Settings

The calculation of the STIPA index may be subject to the purchase of specific options. Check the activation of the option as described in [13.4.1 on page 149](#).

- **Activating the STI:** to activate the STI measurement function go to:



SETTINGS > SOUND MEASURE > STI

| Parameter | Value | Description |
|----------------|-------|--|
| STI measure | ON | Active STI index measure |
| | OFF | STI index measurement deactivated |
| STI amb. Noise | ON | Enable background noise correction for STI calculation |
| | OFF | Background noise correction switched off |

- **Background noise correction:** to use the background noise correction for the calculation of the STI, it is necessary to have the values of the background noise spectrum in octave bands from 125Hz to 8KHz. Values can be entered manually in:



> OCTAVE > STIPA NC

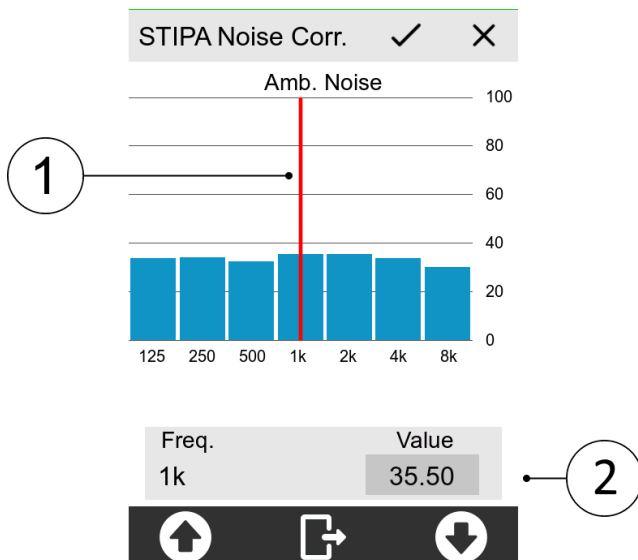



STIPA Noise Correction: manual input of background noise values used for STI index correction

- 1 **Cursor:** select frequency band

- 2 **Input area:** tap to enter the numerical value for the selected frequency band

10.16.2 Measurement and Graphic Output

The main screen for managing the STI parameter measurement is the OCTAVE view. After setting the necessary parameters as described in [10.16.1 a pag. 123](#) go to the OCTAVE screen.

- **Background noise measurement:** measure the background noise in octave bands in the room with the audience present and the noise level that would be expected in the room under normal use; store the values. If *STI amb. noise* set ON and background noise values entered as indicated in [10.16.1](#) STI detection will apply the correction for background noise.
- **Start STI measurement:** if the measurement involves the test signal being emitted through a voice reproduction system, adjust the gain appropriately to produce a level in the room equivalent to that normally generated by the system. Perform TSI measurement in the empty environment (without audience).
- **Start** measuring with the  key (Measurement with storage).
- After **activating** the source with a proper modulated signal, press the  key to start the STI calculation. The TSI value is displayed after approx. 20s. If the resulting value of $STI < 0.63$, perform at least 3 repetitions for each position in the room; the deviation must be < 0.03 .

It is possible to display numeric values of the STI index in views SLM, OCTAVE and TABLE.

OCTAVE view

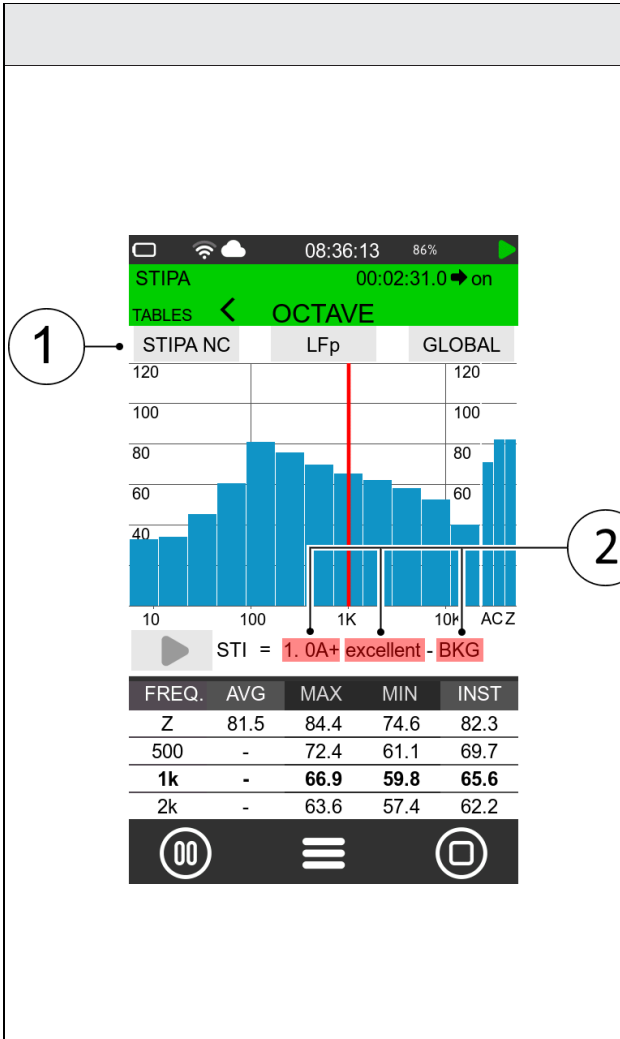

1 → STIPA NC

2 → STI = 1.0A+ excellent - BKG

| FREQ. | AVG | MAX | MIN | INST |
|-----------|------|-------------|-------------|-------------|
| Z | 81.5 | 84.4 | 74.6 | 82.3 |
| 500 | - | 72.4 | 61.1 | 69.7 |
| 1k | - | 66.9 | 59.8 | 65.6 |
| 2k | - | 63.6 | 57.4 | 62.2 |

STIPA NC (Noise Correction): provides access to the panel for manual input of **background noise** values. The background noise values are used as STI index corrections if SETTINGS > SOUND MEASURE > STI > STI amb.noise=ON

1

Measured values Area: displays the results of the measurement. The measured value of the STI index consists of the following information:

- **STI Index value:** the index takes values between 0 (not intelligible) and 1 (excellent intelligibility). Higher values indicate better intelligibility.
- **Category:** the value of STI is followed by an alphabetic character that can take the following values:
A+, A, B, C, D, E, F, G, H, I, J, U, V
See [Table 2](#) for more details
- **STI label category:**
 - 0.00 - 0.30 → Bad intelligibility (BAD)
 - 0.30 - 0.45 → Poor intelligibility (POOR)
 - 0.45 - 0.60 → Acceptable intelligibility (FAIR)
 - 0.60 - 0.75 → Good intelligibility (GOOD)
 - 0.75 - 1.00 → Excellent intelligibility (EXCELLENT)
- **BKG:** the label indicates that the background noise values entered in STIPA NC are applied as STI index correction

SLM view

| | |
|--|--|
| | <p>1 Parameter selector: tap to access the parameter list. Select STI. For more info see 9.3 on page 68</p> <p>2 STI Value: displays the measured value of the STI index</p> |
|--|--|

In order to provide a design indication and measurement tolerance, the qualification scale is divided into several bands. The STI value required for a given application can be obtained from the table below.

Table 2 - Categories STI values

| Category | Nominal STI value | Type of message information | Examples of typical uses (for natural or reproduced voice) | Comment |
|----------|-------------------|------------------------------------|--|--|
| A+ | >0.76 | | Recording studios | Excellent intelligibility but rarely achievable in most environments |
| A | 0.72-0.76 | Complex messages, unfamiliar words | Theatres, speech auditoria, parliaments, courts, Assistive Hearing Systems (AHS) | High speech intelligibility |
| B | 0.68-0.72 | Complex messages, unfamiliar words | | |
| C | 0.64-0.68 | Complex messages, unfamiliar words | Lecture theatres, classrooms, concert halls | High speech intelligibility |
| D | 0.60-0.64 | Complex messages, unfamiliar words | Concert halls, modern churches | Good speech intelligibility |
| E | 0.56-0.60 | Complex messages, familiar context | PA systems in shopping malls, public buildings' offices, VA systems, cathedrals | High quality PA systems |
| F | 0.52-0.56 | Complex messages, familiar context | PA systems in shopping malls, public buildings' offices, VA systems, cathedrals | Good quality PA systems |
| G | 0.48-0.52 | Complex messages, familiar context | Shopping malls, public buildings' offices, VA systems | Target value for VA systems |
| H | 0.44-0.48 | Simple messages, familiar words | VA and PA systems in difficult acoustic environments | Normal lower limit for VA systems |
| I | 0.40-0.44 | Simple messages, familiar words | Shopping malls, public buildings' offices, VA systems | |
| J | 0.36-0.40 | | Not suitable for PA systems | |
| U | <0.36 | | Not suitable for PA systems | |

TABLE view

SLM
< TABLES >
OCTAVE

LAFp = 89.7 LAeq = 89.4

STIPA

| Freq. | Mod0 | Mod1 |
|-------|------|------|
| 125 | 0.50 | 0.56 |
| 250 | 0.70 | 0.72 |
| 500 | 0.73 | 0.75 |
| 1k | 0.77 | 0.76 |
| 2k | 0.74 | 0.76 |
| 4k | 0.71 | 0.73 |
| 8k | 0.76 | 0.73 |

1

Mod0-Mod1: modulation ratios by octave bands. Based on the modulation frequencies of the source signal (see [Table 1 page 122](#)), the *Modulation Transfer Function* is calculated for each octave band and for the two modulating frequencies. The Mod0-Mod1 values indicate how much the source signal is degraded in each octave band by the measurement environment.

10.16.3 Storage of results

Exclusively in “Measurement with Logging” mode, the STI meter stores the measured data in the file *Stipa.txt* available in the folder *Units:\XPT800_2404A00XXX\Measure\MyMeasure...*

The file *Stipa.txt* contains the octave-band **STI** results (125Hz-8KHz bands) of each measurement taken in sequence. Measurements are stored in one file if the “Measurement with logging” mode is not interrupted during the sequence of STI measurements.

```
XPT800
STIPA
```

| Time | TAG | MEAS POS | SOURCE POS | STIPA | BAND | QUALITY | Leq 125Hz | ... | Leq 8kHz |
|--------|-----|----------|------------|-------|------|---------|-----------|-----|----------|
| 31400 | - | 1 | A | 0.69 | B | good | 82.4 | ... | 61.0 |
| 78200 | - | 2 | A | 0.30 | U | poor | 81.0 | ... | 80.9 |
| 117900 | - | 3 | A | 0.49 | G | fair | 81.2 | ... | 81.2 |
| 153400 | - | 4 | A | 0.53 | F | fair | 81.4 | ... | 81.4 |

Background Noise values (125Hz-8KHz bands) if correction for noise floor is activated.

| Lbkg 125Hz | ... | Lbkg 8kHz |
|------------|-----|-----------|
| 40.0 | ... | 40.0 |
| 40.0 | ... | 40.0 |
| 40.0 | ... | 40.0 |
| 40.0 | ... | 40.0 |

The values of **Mod0-Mod1** (125Hz-8KHz bands) for the 2 modulation frequencies.

| md125Hz | md125Hz | ... | ... | md8kHz | md8kHz |
|---------|---------|-----|-----|--------|--------|
| 1.6Hz | 8.0Hz | | | 2.5Hz | 12.5Hz |
| 0.80 | 0.79 | ... | ... | 0.79 | 0.77 |
| 0.00 | 0.00 | ... | ... | 0.99 | 0.97 |
| 0.00 | 0.00 | ... | ... | 0.00 | 0.00 |
| 1.00 | 0.99 | ... | ... | 0.00 | 0.00 |



10.17 Screenshots

The XPT800 sound level meter has a versatile screen capture function.

The function is available at any time, whether the instrument is measuring or stopped.

Activation

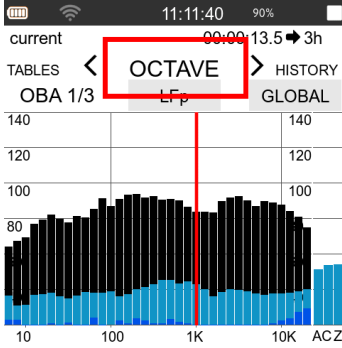
To capture the screen, proceed as follows

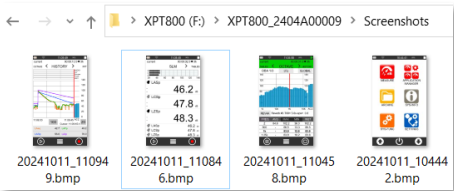
| | |
|---|--|
| <p>Screen Capture</p> <p>1</p> <ul style="list-style-type: none"> Select the screen of interest Tap the status bar Tab screenshot icon (fast settings) |    |
| <p>Storage of screen capture</p> <p>Screen storage is automatic. The storage path is:</p> <p style="text-align: center;"><i>Unit:\XPT800_myserial\Screenshots</i></p> <p>2</p> <p>The format is bitmap type <i>.bmp</i> File name is automatically assigned with date and time of capture</p> <p style="text-align: center;"><i>YYYYMMDD_hhmmss.bmp</i></p> |  |

Size in memory

Each screenshot creates a 751 KB file in the sound level meter memory. It is suggested that screenshots be deleted periodically so as not to excessively reduce the memory available for storing measurements.

10.18 Notifications and automatic updates

Receiving and reading update notifications

The XPT80X sound level meter can receive notifications and updates via the network regarding:

- **Application Firmware:** availability of device firmware updates
- **Wi-Fi Firmware:** availability of Wi-Fi module firmware updates
- **Instrument Options:** receipt and activation of subsequently purchased firmware options
- **Notifications:** other communications, including commercial information or information on new features

The receipt of a notification is highlighted on the status bar by the symbol 

To read notifications go to
SYS-FUNC/NOTIFICATIONS/LIST

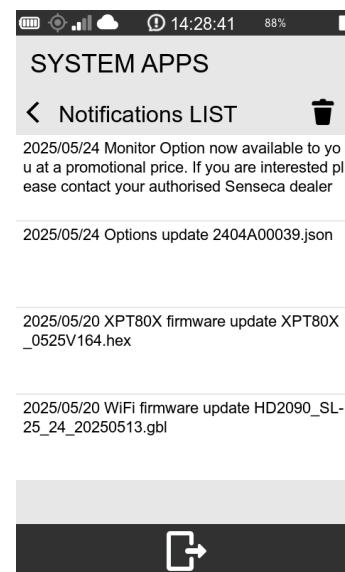

Activating/deactivating notifications

You can select which categories of notifications to receive by accessing SYS-FUNC / NOTIFICATIONS / AUTHORIZATIONS

- Application Firmware
- Wi-Fi Firmware
- Instrument Options
- Notifications

Click the check-box to agree to receive the selected notification category

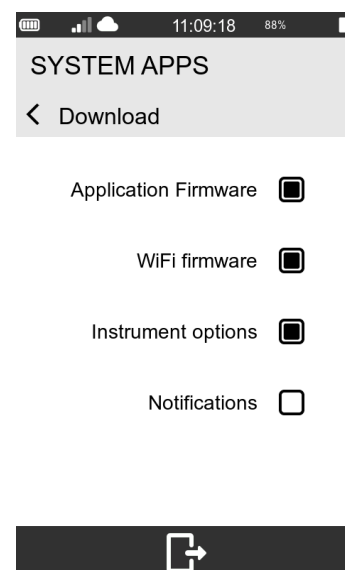

Possible actions following receipt of a notification

| | |
|-----------------------------|---|
| Application Firmware | Receipt of the notification indicates that a new firmware has been downloaded and copied to the >Firmware folder. The firmware is not installed automatically. The user must activate the firmware update procedure |
| Wi-Fi Firmware | Receipt of the notification indicates that a new Wi-Fi firmware has been downloaded. The firmware is installed automatically when the device is restarted |
| Instrument Options | Receipt of the notification indicates that a new set of options has been downloaded. The new options are installed automatically and will be visible after device reboot |
| Notifications | Informative content only |

11 Managing measurement data files

Each time a measurement with logging is performed, a folder is created in the active storage device containing data files with the extension *.dodl and other file types.

The folder path is as follows:

Unit_name:\XPT800_My_serial_number\Measure\yyyyMMdd_hhmmss\ .

If the parameter SETTINGS > DATALOGGER> SETUP> **Log_sequence = OFF**, the instrument creates a folder with the start date and time of the new acquisition in the name. In this way, each measurement corresponds to a new folder.

If the parameter SETTINGS > DATALOGGER > SETUP> **Log_sequence = ON***, the measurements are stored in the same folder and the name of each data file is preceded by a sequential numbering such as: 0001_globals.dodl, 0002_globals.dodl for globals-type data files, or 0001_history.dodl, 0002_history.dodl for time history-type files, and so on for other types of data files such as Reports, Events, etc..

Although the **XPT800** instrument has 4GB of available internal memory other storage options are available:

- USB-C: external storage device
- Cloud: manual or automatic upload of data to NS-Storage web service

11.1 Setting the data file storage unit

The instrument allows you to use the internal eMMC memory or alternatively an external USB-C drive.

Selection of memory to be used is automatic:

- if NO external drive is inserted, the storage location is automatically set to the internal eMMC memory
- if an external drive is inserted on USB port, the storage location is automatically set to the external USB-C type drive.

11.1.1 Saving data to an external USB-C drive

As an alternative to the internal eMMC memory, external USB-C type storage devices can be used for data storage (**audio recordings are disabled on USB external memory**) by plugging into the connector on the bottom panel. Use **exFAT** (Extended File Allocation Table) file system to format USB external drive

To enable writing onto the external storage device:

- switch OFF the instrument
- plug the device into the USB-C port
- switch the instrument ON (in some cases, inserting the device automatically switches the instrument on).

Storage on an external USB device is indicated, after the log is started, by the icon  on the status bar.

11.2 Information on data file naming

Structure and naming of the folder containing data files with the *.dodl extension and other file types.

11.2.1 Parameter Log_sequence = OFF

(SETTINGS > DATALOGGER> SETUP > Log_sequence)

With the parameter Log_sequence = OFF, data files are stored in different folders for each measurement taken. With each new measurement, a folder is created with a name corresponding to the date and time the measurement started..

Example:

Unit_name:\XPT800_My_serial_number\Measure\20240527_104537\ globals.dodl

Unit_name:\XPT800_My_serial_number\Measure\20240528_160825\ globals.dodl

Files contained in the folder relating to a measurement (parameter Log_sequence = OFF):

| Type | File name |
|---------|--------------------------------|
| Globals | globals.dodl |
| History | history.dodl |
| Reports | reports.dodl |
| Eventi | events.dodl |
| Audio | audio0001.wav audio0002.wav |

11.2.2 Parameter Log_sequence = ON*

(SETTINGS > DATALOGGER> SETUP > Log_sequence)

With the parameter Log_sequence = ON the data files of one or more measurements are stored in the same folder, the name of the data files will be preceded by sequential numbering.

Example:

unit_name:\XPT800_My_serial_number\Measure\20240529_152256\0001_globals.dodl

unit_name:\XPT800_My_serial_number\Measure\20240529_152256\0002_globals.dodl

Files contained in the folder (parameter Log_sequence = ON):

| Type | Sequence | File name |
|---------|----------|--------------------|
| Globals | 0001 | 0001_globals.dodl |
| | 0002 | 0002_globals.dodl |
| History | 0001 | 0001_history.dodl |
| | 0002 | 0002_history.dodl |
| Reports | 0001 | 0001_reports.dodl |
| | 0002 | 0002_reports.dodl |
| Events | 0001 | 0001_events.dodl |
| | 0002 | 0002_events.dodl |
| Audio | 0001 | 0001_audio0001.wav |
| | | 0001_audio0002.wav |
| | 0002 | 0002_audio0001.wav |
| | | 0002_audio0002.wav |

* Function Tba

11.3 Using the data file Archive

The measurement records made in datalogging mode are stored in the device and visible via the ARCHIVE function. The archive function **only displays data stored in the eMMC memory device**.

The preview mode displays the main measurement information and also has features such as:

- Measurement list
- Filter
- Manual synchronization on cloud of a single file or a folder
- Voice note



11.3.1 Selecting measurements to display

The measurement data files can be viewed in the ARCHIVE section.





Notice!

With a measurement in progress, the archive only allows access to the list of measurements. It is not possible to view archived data.



- 1 In the ICON MENU, press the **ARCHIVE** icon 
- 2 Tap icon  to view the complete list* of measurements
- 3 The list of recordings identified by the name of the storage folder with date and time is displayed

**It's possible to display up to 100 measurements*

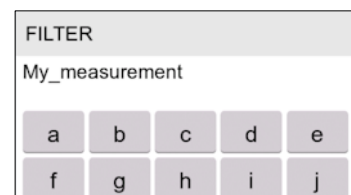

- 4 If necessary, press  the central icon (FILTER)
- 5 If necessary, select one or more check-boxes relating to:
 - T.History
 - Reports
 - Events
 - Globals
 - Audio
- 6 Enter the search string in the field to display only specific **folder names**
- 7 Tap the central icon in the control bar  to confirm the filter-string settings and access the filtered list

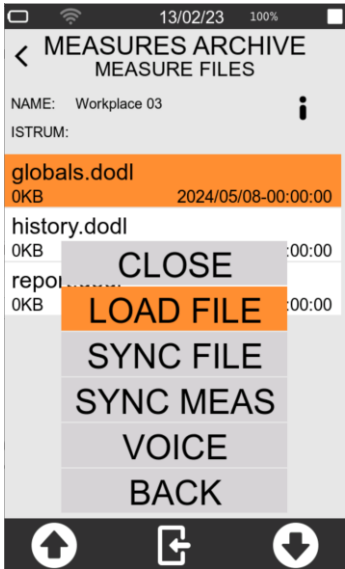

| | |
|--|---|
| <p>8 Tap or use the arrows (UP/DOWN) and the central icon  to access the folder.</p> <p>9 Select the .dodl file (globals, history, report)</p> <p>10 Tap  to access the context menu</p> <ul style="list-style-type: none"> • Tap CLOSE to go back the folder content • Tap BACK to go back to the list of measurements • Tap  to display measurement settings used (MEAS) or general device information (INFO) <p>11 Tap LOAD FILE to display selected .dodl measurement</p> |  |
|--|---|

11.3.2 Displaying Globals measurements



To select a Globals file see “11.3.1” on page 132

Tap LOAD FILE to display selected measurement

Tap  to display measurement file Information (full list of parameters recorded)

11.3.3 Displaying History and Reports measurements

To select a History.dodl or Reports.dodl file see “11.3.1” on page 132

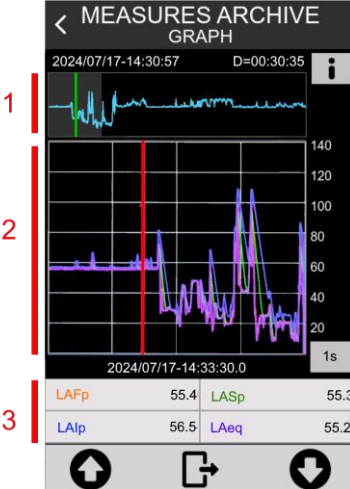
| | | | | | | | | | |
|--|---|------|------|------|------|------|------|------|------|
| <p>1 In the context menu, tap LOAD FILE to display selected measurement</p> |  | | | | | | | | |
| <p>The graphic window is divided into three zones named 1 <i>Navigation Window</i>, 2 <i>Time history window</i> e 3 <i>Table of numerical values</i></p> <p>a. Tap  to display measurement file Information (full list of parameters recorded)</p> |  <table border="1" data-bbox="1077 1854 1388 1915"> <tr> <td>LAFp</td> <td>55.4</td> <td>LAsp</td> <td>55.3</td> </tr> <tr> <td>LAIp</td> <td>56.5</td> <td>LAeq</td> <td>55.2</td> </tr> </table> | LAFp | 55.4 | LAsp | 55.3 | LAIp | 56.5 | LAeq | 55.2 |
| LAFp | 55.4 | LAsp | 55.3 | | | | | | |
| LAIp | 56.5 | LAeq | 55.2 | | | | | | |

Navigation window: displays the complete track and allows selection of a reduced time interval which is displayed in zoom mode in the time history window (below)

- b. Top left: date and time of **measurement start**.
 - c. Top right: **measurement duration**
- 2 Tap the green cursor to select the position in the portion of the track of interest (the lower window will synchronize)

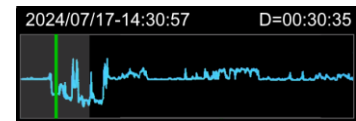

Time history window: enlarges (zooms) the time interval selected in the navigation window



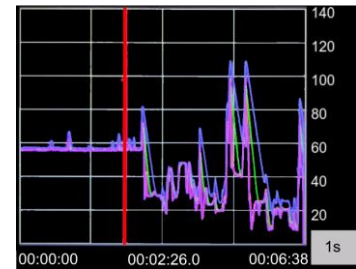

- a. Bottom left: time (relative to start of measurement) of the initial instant of the window
- b. Middle: time (relative to start of measurement) of the instant relative to the red cursor position
- c. Bottom right: time (relative to start of measurement) of the final instant of the window
- d. Right button **1s** : selects the time resolution for plot display



- 3 Tap the red cursor to place it on the event of interest and activate the **Navigation Bar**
- a. **Date and absolute time** related to the position of the red cursor are displayed below the graph
 - b. The *table of numerical values* with 4 measurement parameters at the bottom allows reading the values at the instant selected by the cursor.
 - i. Touch the parameter to select another or deactivate its display



Navigation Bar

- c. Moves the time history plot by an interval equivalent to 1/2 of the window duration to the left  or right 
- d. Moves cursor one point to the left  or right 
- e. Closes the navigation bar 



11.3.4 Manual cloud synchronisation of data files

Synchronisation consists in sending all or part of the measurement data contained in the archive to the *Noise Studio Cloud Storage* service (NS-Storage). In order to synchronise data directly from the device, it is necessary that the instrument, equipped with the OF5S option, is connected to the service via the Wi-Fi communication device (or LAN or 4G if available) and access to the service via credentials is made (see “[11.4.2 Data storage on Cloud](#)” on page 136).

- 1 Select **SYNC FILE** to upload the individual measurement file to the cloud * (ie. globals.dodl or history.dodl ecc.)
- 2 Select **SYNC MEAS** to send the folder containing all files to the cloud. (ie. My_Measurement)
- 3 Check on the status bar the icon  indicating that synchronisation is in progress

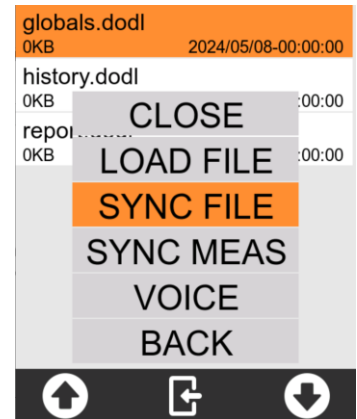

* Each measurement file is identified by a **unique ID** that allows measurements sent to the cloud at different times to be correctly grouped together

11.3.5 Entering a voice note to the measurement

It is possible, from the measurement Archive, to associate a voice comment to measurements after they have been completed. The comment is stored in wav format (file name voice.wav) within the folder relating to the measurement.

- 1 Select **VOICE** to enter a voice note to the measurement
- 2 In the control bar, tap the  button and speak into the microphone
- 3 Press the STOP button to end the voice note

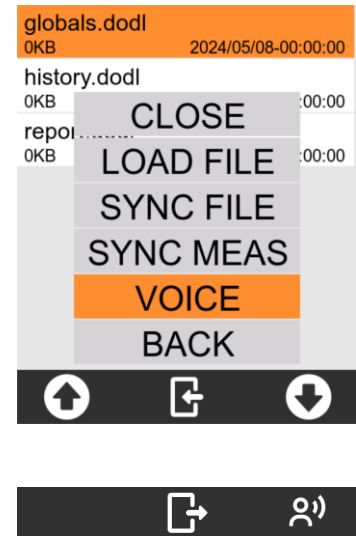

11.3.6 Renaming and deleting a data file



Notice!

It is not possible, from the user interface, to rename and delete measurement data files. For this purpose, use a PC and access the storage drive via USB (activate File Write USB in SYS-FUNC/USB). See section “[11.4.1 Saving on PC](#)” on page 136.

11.4 Saving of data files

The standard storage format of the XPT800 sound level meter is *.dodl (proprietary format). Files of type dodl contain information in binary format that cannot be read directly. To read the information, it is necessary to convert the dodl format via a converter (parser) integrated in the *NS-Storage* portal (<https://noise-studio.senseca.com/>) available to Senseca sound level meter owners. Once converted via the parser, the data can be viewed directly on the NS Web Storage portal and can be exported in text or Excel formats. From the NS Web Storage portal, data can be imported into data analysis software modules such as *NS-ENS* (<https://environmental.senseca.com/support/software/environmental-noise-studio-ns-ens/>). For specific applications, a **local parser** can be provided, e.g. for the exclusive use of Public Administrations or organisations with specific data privacy requirements.

11.4.1 Saving on PC

Connect the **XPT800** instrument to a PC (Windows and Mac) using a USB-C cable connected to its connector.

Now the instrument will be visible as a peripheral drive, you can manage your recording data files.



Info

Refer to chapter “**12 Network and connections**” on page 138 to make the connection properly.

11.4.2 Data storage on Cloud

It is possible to upload measurement data files to the *NS Cloud Storage* service. There are two ways of uploading from DEVICE directly or from a PC.

From DEVICE

Automatically (“**11.4.3 Automatic cloud synchronisation of data files via Push option**”) or **manually** by selecting the measurement from the measurement archive (“**11.3.2 Displaying Globals measurements**”), the instrument uploads the measurements to the NS-Storage portal.

From PC

Selecting individual dodl files or complete folders containing measurements (dodl, wave, etc.) directly from the instrument's eMMC memory or from files stored on a PC and uploading the measurements to the NS-Storage portal.

To upload in manual mode, it is necessary to:

- have a PC connected to the Internet.
- have saved files on the PC or on an external drive connected to the PC.
- have an e-mail address.
- log on to <https://noise-studio.senseca.com/> and follow the registration procedure via the e-mail address.

Once the workspace has been accessed, it is possible to upload the measurement data files.

- 1 Select the 'File' panel.
- 2 Fill in the mandatory fields marked with an asterisk:
 - session name prefix: enter the name you wish to assign to the recording;

- choose the time zone of the recording location.
- 3 Select a single file or a directory to upload several files simultaneously.
 - 4 Press "Upload", if the upload was successful, the message "File successfully uploaded" will appear

11.4.3 Automatic cloud synchronisation of data files via Push option

To automatically upload (*push mode*) measurement data from XPT80X device to the NS-Storage portal <https://noise-studio.senseca.com/workspaces>, it is necessary to:

- A) Have the OF5S option active on the XPT80X device
- B) Set up the data **destination workspace** on the Devices portal
- C) Set the **address of the management server** on the XPT80X device.
- D) Set the synchronisation parameters on the XPT80X device
- E) Activate synchronization on the device and run measurement

Setting up the data destination workspace on the Devices portal

The destination workspace for data synchronized by the XPT80X device can be set in the *Devices* service at the following url:

<https://devices-noise-studio.senseca.com/>

- Sign in with your credentials
- Select *Remote Devices*

| Serial Number | Type | Name | Last connection | Next connection | Active | Under maintenance | Actions |
|---------------|-------|-------|---------------------|-----------------|--------|-------------------|---------|
| 2404A00023 | H2090 | James | 2025-01-10 09:31:39 | | ✓ | X | > X ⚙️ |
| 2404A00009 | H2090 | John | 2025-01-10 12:34:49 | | ✓ | X | > X ⚙️ |

- Identify the device through the *Serial Number* field
- Press > to access device details and settings
- Select *Update workspace* tab
- In the *Workspace* field select the workspace (previously created in the NS-Storage portal) of destination for measurement data to be synchronized (at least one workspace must be present in the NS-Storage portal)

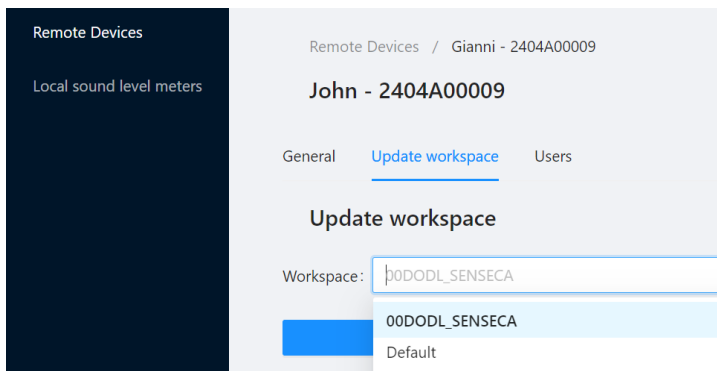

- Select Update to confirm the workspace assignment

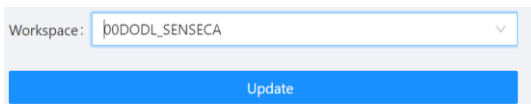

Setting the address of the management server on the XPT80X device.

Note: The management server url is set by default at the factory. If not set, proceed as indicated in the following points

- set the cloud server in SETTINGS/INTERFACES/NET:
Cloud address: api-devices-noise-studio.senseca.com
- have internet access via WiFi, 4G or Ethernet cable, see the relevant chapters [12.2 “Connecting to a WiFi network” on page 140](#) and [12.3 “Connecting to an Ethernet port” on page 142](#)

Setting the synchronisation parameters on the XPT80X device





> DATALOGGER > SETTINGS

- **File max size:** the measurement is divided into partial files of the set size. The partial data file is stored and synchronised on the cloud when the set size is reached or when the measurement is STOPPED. Smaller sizes correspond to more frequent synchronisations.
- **Sync Files:** selects the file types to be synchronised between: REPORT, EVENTS, GLOBALS, AUDIO, FFT.
 - Note: the selection of HISTORY type files is active by default
 - Note: AUDIO type files, if selected for synchronisation, are only sent to the cloud at the end of the measurement (in STOP).
- **File max duration:** the measurement is divided into partial files of the set duration. The partial data file is stored and synchronised on the cloud when the set period is reached or when the measurement STOPS.

Activating synchronization and starting the measurement

Synchronization is not enabled by default on the device. To activate it, proceed as follows:

- press  on the status bar (fast settings).
- press the key  to start measurement in data logging mode

If an internet connection is available and cloud access is enabled (☁), measurement data are automatically synchronized to the NS-Storage cloud within the previously set workspace. The synchronization is indicated as follows:



Synchronization queue (black or white arrows)



Synchronization in progress (green arrows)

- To view synchronised measurement data, access the workspace created in the NS-Storage portal and selected as the destination for measurement file synchronisation in NS-Device



Info

All files, whether synchronised or not, remain stored in the device's internal memory.



12 Network and connections

12.1 Network Settings

In order to be connected to the Internet, the instrument must be activated by the manufacturer via the *NS-Devices* service. The (editable) URL of the site accessed by the device is set as a default parameter directly in the network settings of the instrument.

12.2 Connecting to a WiFi network

To configure and connect the instrument to an existing WiFi network, proceed as follows:

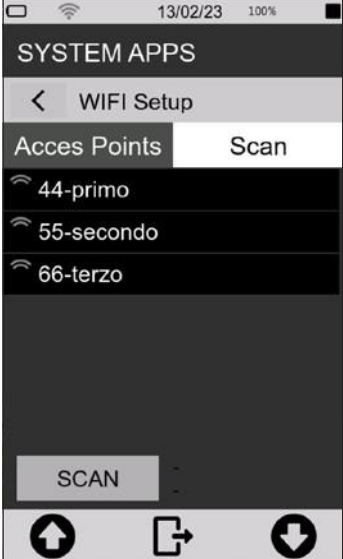
| | |
|--|---|
| <ol style="list-style-type: none"> 1 Tap the icon in the status bar to activate Wi-Fi |  |
| <ol style="list-style-type: none"> 2 In the ICON MENU, press the SYS-FUNC icon to access the system app menus. 3 Access the NETWORK CONNECTION page and press on 4 WIFI to access the WiFi Setup page. |  |
| <p>Scan panel In this panel, available access points are detected.</p> <ol style="list-style-type: none"> 1 Press the SCAN button to scan for available access points. 2 Click on one of the displayed access points to access the Access point setup panel for SSID configuration, security, and password entry. 3 Press the button ✓ to confirm. The selected access point is entered into the "Access Points" panel and stored in a list. The user has the option of removing or changing the access points in the list. |  |

Access Points panel

The names of the access points stored from the 'Scan' panel appear in this panel.

- Select an access point, press the buttons to perform the desired operation:

 = press the button to **connect the device to the selected access point**. Within the list, successful connection is indicated by an icon at the selected network. In the status bar, successful access to the network is indicated by the active Wi-Fi icon, which also indicates the level of the available signal. The presence of a **padlock** next to the Wi-Fi icon indicates that the network is protected.

 = press the button to access the panel for **configuring SSID**, Security and entering the password of the selected access point

 = press the button to **remove the selected access point** from the list, to retrieve it the scan must be performed again

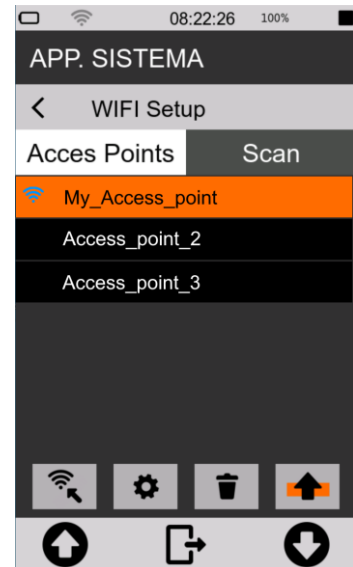

 = press the button to **move the selected access point** to the top of the list.



Info

Should the active access point be switched off or no longer available, an automatic search for a connection to the first available access point from the top of the list will be carried out.

Access points setup panel

- tap on the fields to activate the keyboard and type in the credentials of the network you want to use.
- Press  to confirm, press  to cancel operation



Info



For details on using the keyboard see chapter [“4.10 Entering text and numbers”](#) on page 29.



12.3 Connecting to an Ethernet port

Through the Ethernet port (port availability depending on options), it is possible to connect the device to the internet using the RJ45 port of the network adapter as a connection device.

To connect the XPT800 to an Ethernet port, follow these steps:

- 1 Make sure you have the following equipment:
 - LAN socket on the instrument (opz.OH3A);
 - Ethernet cable;
 - a functional Ethernet network port.
- 2 Connect the **XPT800** instrument to a network using the Ethernet cable plugged into the LAN socket.
- 3 From the drop-down menu, tap the icon  to select the connection device. The successful activation of the interface is indicated by the blue icon; other network interfaces are disabled.
- 4 Wait until the 'LAN' icon  appears in the status bar, indicating successful connection.



Info

For details on the instrument's network settings, please refer to chapter “[12.1 Network Settings](#)” on page 140.



Notice!

Ethernet connections use a lot of energy. It is recommended to also connect the instrument to an external power source via USB while connected.

12.4 Connecting through GSM network

To establish an Internet connection via the GSM network, the following is required:

- Hardware options installed on the device: XPT800-OH3A, XPT800-OH3M
- Firmware options active on the device: XPT800-OF5S (included in XPT800)
- ANTGSM8 external antenna to be connected to its connector (see also [pag. 18](#) *Errore. L'origine riferimento non è stata trovata.*)
- SIM card (Nano SIM - 4FF) with **data service** enabled
- Access Point Name (**APN**) of the provider for access to the service

12.4.1 Installing a SIM card

The SIM card slot is located inside the battery compartment (for details see on [pag. 18](#)). For instructions on opening the battery compartment refer to [5.5.3 on pag.43](#).

Once the battery compartment is open, the slot for the Nano SIM card will be visible.

For installation proceed as follows.

1 Slide metal lid from “LOCK” position to “OPEN” position

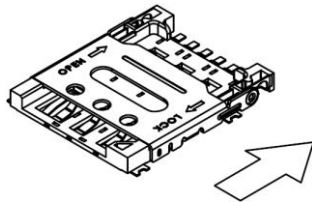

2 Open metal lid to allow Nano SIM card to be inserted

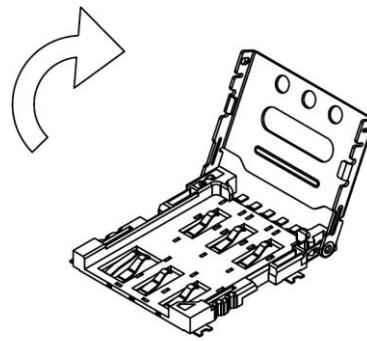

3 Place Nano SIM card against contacts, chip face down

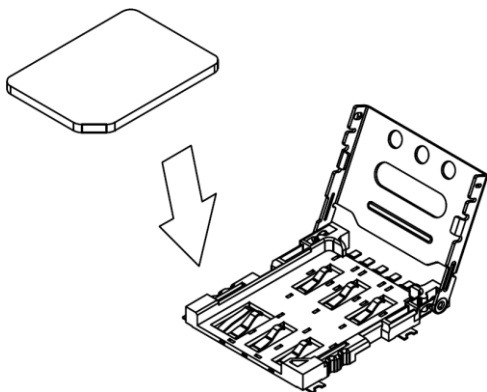

4 Close metal lid

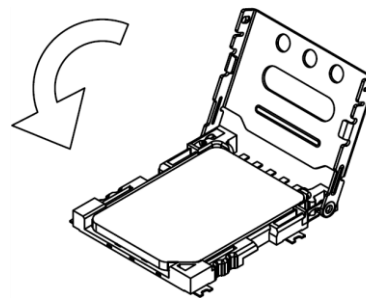

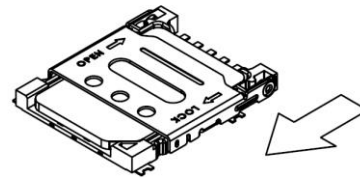

5 Slide back to “LOCK” position





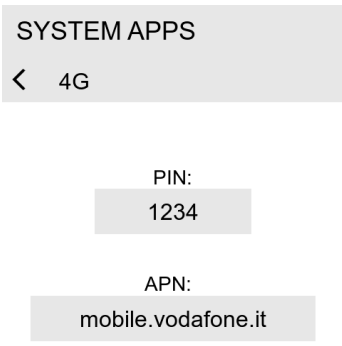

12.4.2 Network Settings

To set the network parameters and connect the device to a GSM network, follow the steps below:

| | |
|--|---|
| <ol style="list-style-type: none"> 1 In the ICON MENU, press the icon  SYS-FUNC to access system app menus 2 Go to the NETWORK CONNECTION page and press on 4G to access the setup page 3 Enter PIN of SIM card 4 Enter network provider's access point name |  |
| <ol style="list-style-type: none"> 5 Activate the Modem icon in the fast settings area. |  |

Once the connection to the GSM network has been established, information on network signal quality and connection status is visible in the status bar:

| Icon | Signal level | Icon | Signal level |
|---|--------------|---|--------------|
|  | 100% |  | 75% |
|  | 50% |  | 25% |
|  | No signal | | |

Note: to obtain a sufficient signal level, the **ANTGSM8** antenna must be connected

12.5 Connecting to a PC with USB interface

Connect the **XPT800** instrument to a PC (Windows and Mac) using a USB-C cable connected to USB connector. The instrument will now be visible as a memory unit.

It's possible to:

- View system files (System)
- display and copy measurement data files (Measure)
- view configurations (Setup)

- view playback files (Traces)

13 Firmware update and options

The firmware, i.e. the program that manages all the instrument's functions, can be updated by transferring the file from a PC to the **XPT800** via the USB-C ports. This allows the functionality of the instrument to be updated.

To proceed with the update, use the FW UPGRADE function accessible from the SYS-FUNC icon.



Warning!

During the procedure the power supply status must be sufficient to perform the update.

- With external power supply, **DO NOT** remove the power cable until the firmware update is complete.
- With battery power, the battery must be close to 100% to ensure that the boot-loader functions are not interrupted and thus avoid possible FLASH memory write errors.



Info

The BL (boot-loader) accepts that there are also other files in the 'firmware' directory. The files will be evaluated starting with the extension ".hex", then whether the attribute "archive" is set, and finally the contents of the APP table "infoAPP" contained in the file. If there is more than one file in the directory that meets these requirements, the first one proposed by the file manager will be used for update.

13.1 Firmware version

To find out the firmware version installed in the instrument.

- 1 In the ICON MENU, press the SYS-INFO icon to access the system information and monitor menus.
- 2 Tap to access the **FIRMWARE** page.

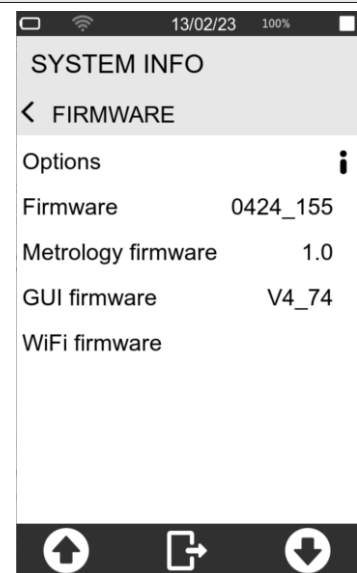

13.2 Firmware update

Updating the firmware requires a PC with a USB port and the file containing the new firmware. Firmware files are of the type:

file_name.hex

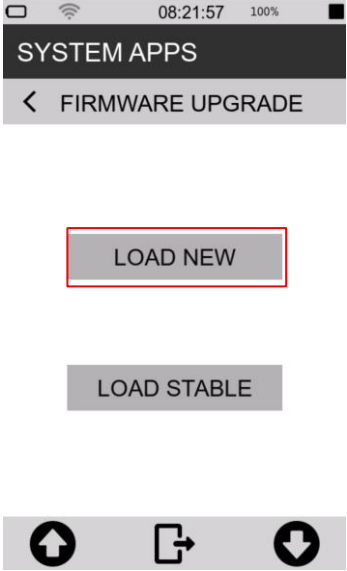
| | |
|--|--|
| <ol style="list-style-type: none"> 1 Turn on and connect the XPT800 Sound Level Meter to the USB port of your PC using USB-C cable. 2 In SYS-FUNC/USB/PROCEDURES press FILE WRITE to activate USB write (don't exit the pop-up!) 3 As soon as access to the memory unit is available, copy the "new_firmware.hex" file to the folder > Firmware. 4 On the FILE WRITE pop-up press EXIT to deactivate USB write 5 Switch the instrument off and on again 6 In ICON MENU, press the SYS-FUNC icon to access the system and measurement configuration menus. 7 Access the FW UPGRADE and PROCEDURES pages in succession. 8 Tap on LOAD NEW. |  |
|--|--|

The device automatically reboots until the splash screen is displayed; the status LED starts blinking green. The update procedure can take between 10 and 20 minutes.

Verify the correct update of the new version as described in chapter “[13.1 Firmware](#)” on page 146.



Info

In the case that the update cannot be carried out, e.g. due to a battery voltage below 3.8V, a running measurement, or a missing correct *.hex file*, a pop-up alerts the user with a message.



Notice!

- In the event that the firmware update fails, the status LED turns red, indicating a possible error in the upload procedure...
- The instrument has a recovery firmware pre-loaded in a non-editable memory area; to restore the firmware, please refer to section “[13.3 Instrument recovery via recovery firmware](#)” on page 149.

13.2.1 Wi-Fi firmware update

Updating the Wi-Fi firmware requires a PC with a USB port and the file containing the new firmware. Wi-Fi firmware files are of the type:

file_name.glb

Wi-Fi firmware update procedure

- 1 Turn on and connect the **XPT80X** Sound Level Meter to the USB port of your PC using USB-C cable.
- 2 In SYS-FUNC/USB/PROCEDURES press **FILE WRITE** to activate USB write (**don't exit the pop-up**)
- 3 As soon as access to the memory unit is available, copy the "*new_firmware.glb*" file to the folder > Firmware.
- 4 On the FILE WRITE pop-up press **EXIT** to deactivate USB write
- 5 Switch the instrument off and on again
- 6 Upgrade monitoring:
 - complete operation will take a couple of minutes
 - status led blinks blue during the operation
 - when the operation succeeds the application starts

Verify the correct update of the new version as described in chapter “[13.1 Firmware version](#)” on [page 146](#).



Info

In the case that the update cannot be carried out, e.g. due to a battery voltage below 3.8V, a running measurement, or a missing correct *.glb file*, a pop-up alerts the user with a message.



Notice!

- If the firmware update fails, the status LED flashes red five times, indicating a possible error in the charging procedure...
- The instrument has a recovery firmware pre-loaded in a non-editable memory area; to restore the firmware, please refer to section “[13.3 Instrument recovery via recovery firmware](#)” on [page 149](#).

13.3 Instrument recovery via recovery firmware

If the firmware update fails, the instrument has a recovery firmware pre-loaded in a non-editable memory area.

The recovery firmware can be reloaded if necessary to restore the instrument.

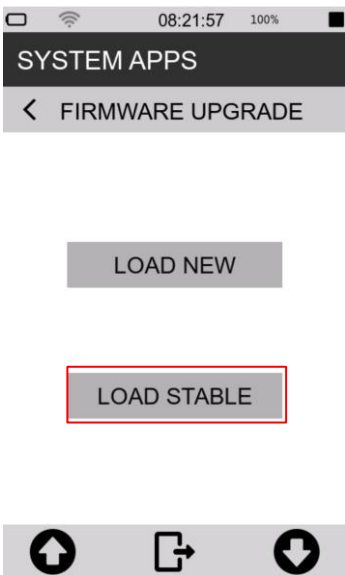
| | |
|--|---|
| <ol style="list-style-type: none"> 1 In the ICON MENU, press the SYS-FUNC icon to access the system and measurement configuration menus. 2 Access FW UPGRADE and PROCEDURES. 3 Press LOAD STABLE. |  <p>The screenshot shows a mobile interface with a status bar at the top displaying the time 08:21:57 and 100% battery. Below the status bar is a dark header with the text 'SYSTEM APPS'. Underneath is a light grey bar with a back arrow and the text 'FIRMWARE UPGRADE'. The main area contains two buttons: 'LOAD NEW' and 'LOAD STABLE'. The 'LOAD STABLE' button is highlighted with a red rectangular border. At the bottom, there is a navigation bar with three icons: an upward arrow, a square with a rightward arrow, and a downward arrow.</p> |
|--|---|

13.4 Enabling or disabling instrument software options

The XPT800 allows the installation of new firmware options without the instrument having to be sent to the manufacturer for upgrade. Contact the sales department for more information on the options available for your instrument.

13.4.1 Verifying the options installed in your device

To check the hardware and firmware options installed in your device and those that can be installed, proceed as follows:

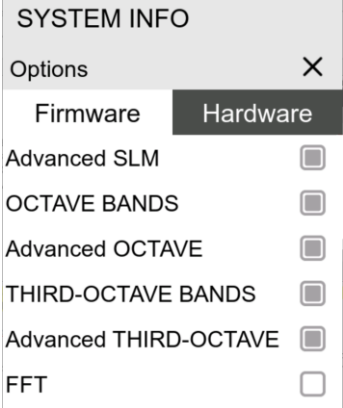
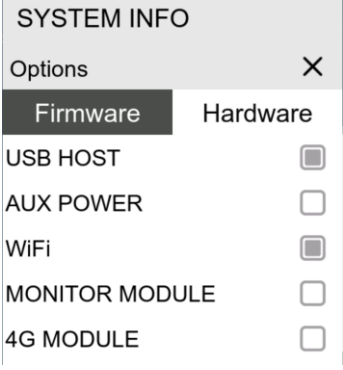

| | |
|--|---|
| <ol style="list-style-type: none"> 1 In the ICON MENU, press the SYS INFO icon to access the system information and monitor menus. 2 Access the FIRMWARE page. <p>Access Options ⓘ to display the list of options active on your device and those that may be purchased and activated</p> |  <p>The screenshot shows a mobile interface with a status bar at the top displaying the time 08:21:57 and 100% battery. Below the status bar is a dark header with the text 'SYSTEM INFO'. Underneath is a light grey bar with a back arrow and the text 'FIRMWARE'. The main area contains two entries: 'Options' with an information icon ⓘ to its right, and 'Firmware' with the value '0424_152' to its right.</p> |
|--|---|

| | |
|---|---|
| <p>3 Tap Firmware tab for the list of firmware options</p> |  |
| <p>4 Tap Hardware tab for the list of hardware options</p> |  |

13.4.2 Enabling new purchased options

Enabling new options purchased after the purchase of the instrument is possible in manual or automatic mode via the NS-Manager web application. Firmware options can also be activated for limited periods of time, i.e. in time-limited rental mode. In manual enable mode, a file is provided containing an unlock code and with the instrument serial number and json extension (*myserial.json*) in the file name.

To enable new options, proceed as follows:

| | |
|--|---|
| <ol style="list-style-type: none"> 1 Switch on and connect the XPT800 Sound Level Meter to the USB port of your PC using USB-C cable. 2 Activate USB write in SYS-FUNC / USB / PROCEDURE >> FILE WRITE 3 Copy the file <i>myserial.json</i> into the folder > Firmware. 4 Deactivate USB write in SYS-FUNC / USB / PROCEDURE 5 Switch the instrument off and on again 6 Check the proper activation of the option in SYS-INFO / /FIRMWARE/Options (see also 13.4.1 a pag.149) | <p>Ex. Option enabled</p>  <p>Ex. Option Not enabled</p>  |
|--|---|

14 Maintenance Operations

14.1 Cleaning the Instrument

Clean the device with a soft, clean cloth or, when necessary, slightly moistened with clean water.



Warning!

Take care that no moisture enters the enclosure.



Forbidden!

Do not use sprays, solvents, alcohol-based cleaners or abrasives.

14.2 Microphone cleaning (microphone diaphragm)

To avoid permanent alterations in frequency response and consequent degradation of performance that may invalidate the instrument's compliance with class 1 tolerance limits, the accumulation of dust and dirt particles on the microphone diaphragm must be avoided.

The microphone capsule and diaphragm must be periodically inspected and, if necessary and possible, cleaned. Inspection and cleaning, if necessary, are normally carried out during periodic calibration at the accredited **Senseca Italy Srl** laboratory.

14.3 Accredited periodical calibration

This must be performed at **Senseca Italy's** UNI CEI EN ISO/IEC 17025 accredited laboratories or at another accredited laboratory for the calibration of sound level meters and octave or third octave filters.

Periodic calibration must be carried out in accordance with international technical standards.



Notice!

It is recommended to calibrate the unit annually.

15 Troubleshooting Guide

15.1 Formatting eMMC memory (FORMAT)



Warning!

Before formatting, all folders in the eMMC memory must be backed up.

Formatting the eMMC memory results in the deletion of the following contents:

- microphone serial number
- system configuration
- access points configurations
- measurement setups in APPLICATION MANAGER
- stored measurement data
- generator files
- audio tracks
- calibration history
- any firmware files (*.hex) loaded in the relevant folder

Two equivalent formatting modes are possible:

- formatting from device
- formatting from PC

Formatting from device

- 1 In the ICON MENU, press the **SYS-FUNC** icon to access the system configuration and measurement menus.
- 2 Access the **INITIALISATION** and **PROCEDURES** pages in succession.
- 3 Press on **FORMAT**. To confirm the operation, press OK, to cancel press CANCEL.

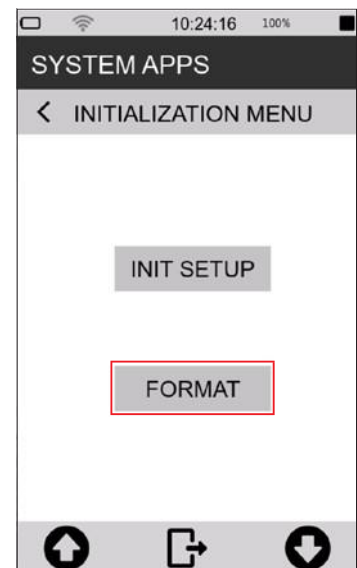

Formatting from pc

The eMMC memory is recognised by the PC as an external drive with the XPT800 model name. The format command available on Windows determines the formatting of data and settings as described in the warning at the beginning of the paragraph. On the next reboot, the sound level meter's operating system restores the device's default settings (please note that the microphone serial number must be restored. See [XPT80X_SLM_Config](#)).

Formatting details:

- Format: exFAT
- Size of allocation unit: 32kilobyte
- Label: XPT800

15.2 Restoring Parameters to Default Settings (Reset)

Resetting the settings resets the setup parameters to the default settings.



Warning!

The Reset procedure, if a formatting has been performed, does not restore all previous conditions.

The reset procedure **does not** delete:

- Measurement data files (unit:\XPT800_XXXXXXXX\Measure)
- Measurement settings (unit:\XPT800_XXXXXXXX\Setup)
- Calibration history

To perform a reset, follow this procedure:

- 1 Ensure that no measuring and recording is in progress.
- 2 Make sure you have saved any configurations being edited in APPLICATION MANAGER.

- 3 In the ICON MENU, press the **SYS-FUNC** icon to access the system configuration menus.
- 4 Access the **INITIALISATION** and **PROCEDURE** pages.
- 5 Touch on **INIT SETUP**. To confirm the operation, press OK, to cancel press CANCEL.

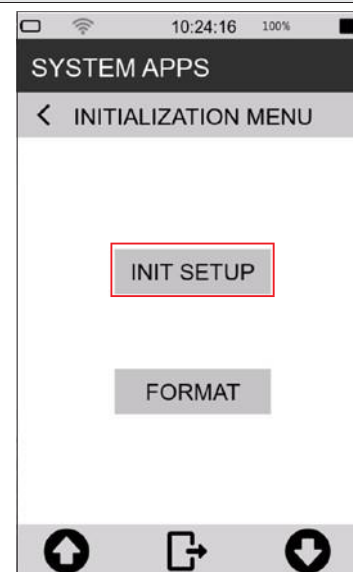

15.3 Malfunctions, causes and possible solutions

❖ Calibration procedure fails:

The calibration correction is applied and written in the Curr.Att. field, along with the date and time, only if it is within the expected range. If the calibration procedure fails, the correction is not applied and written.

Failure to apply the correction may be due to the following factors:

- microphone out of nominal specification
- sound calibrator out of nominal specification
- acoustic calibrator off or with incorrect level setting
- expected calibration value (expected field) not set correctly with respect to the calibrator used.

Possible solutions:

- Ensure that the instrument is not exposed to high noise and/or vibration and that the acoustic calibrator and sound level meter are firmly aligned, and the microphone is fully inserted into the calibrator cavity.
- Check that the rubber sealing ring inside the calibrator cavity is not damaged and is correctly positioned.
- Repeat after waiting for the end of the stabilization time.

❖ **The sound levels measured by the sound level meter appear to be incorrect:**

- Check that the preamplifier is fully inserted into the connector on the sound level meter (the push-pull connector "clicks" when correctly inserted).
- Ensure that the microphone capsule is correctly screwed onto the microphone preamplifier.
- Verify that there is no dirt on the microphone protection grid.
- When using a microphone extension cable, try connecting the preamplifier directly to the sound level meter, excluding the cable as a possible cause of malfunctioning.
- Check that the displayed acoustic parameter is correct (we recommend using an instantaneous parameter such as LAFp)
- Check that the microphone protection grid is screwed tightly onto the capsule.
- Ensure that there is no condensation on the microphone capsule or preamplifier. Avoid switching on the sound level meter in conditions where condensation may occur. For measurements in high humidity or rain, use the WSO outdoor microphone protection unit.
- Activate the preamplifier heater.

❖ **The sound level meter switches off immediately after the power-up presentation screen:**

- Battery is depleted and must be charged, use external power supply as an alternative.

❖ **The sound level meter does not communicate with the PC:**

- Check that the connection cable is correctly plugged into the USB-C connector on the sound level meter and that it is connected to a USB socket on the PC.
- If the USB interface is used, check that, on the sound level meter, are not activated functions for which the USB port is to be disabled (e.g. Log_Sync or measurement with storage).

❖ **Continuous logging cannot be activated. The instrument starts measurements without data recording:**

- Out of memory. Download data and/or delete memory.

❖ **Manual audio recording does not work:**

- Check that the audio logging mode is on TRG (EDIT APP > LOG > AUDIO > Audio logging = TRG).

❖ **Automatic audio recording does not start:**

- Check that the audio logging mode is on TRG (EDIT APP > LOG > AUDIO > Audio logging = TRG).
- Verify trigger input (EDIT APP > TRIGGER > INPUT > SLM = activate check box for parameter on which trigger thresholds are set).
- Check the activation thresholds values by tapping on the parameter selected for triggers in the SLM screen.

16 Long-term storage

- Switch off the instrument as indicated in chapter “[6.3 Switching off](#)” on page 47.
- If the instrument is to be stored for more than 2 weeks, remove the battery as indicated in chapter [5.5.3 on page 42](#).
- We recommend storing the instrument in its case and in a dry environment.



Warning!

In case the instrument is externally powered or charging, do not remove the power cord before turning off the instrument. Removing the power cable with the instrument still on, could result in the loss of unsaved data.

17 Spare parts

For spare parts, please contact Senseca Italy Srl or an authorised dealer.

| Code | Description |
|---------|---|
| ANTGSM8 | External Antenna for GSM module |
| BAG8K | Rugged carrying case (big version) 465 x 355 x 145 mm |
| BAT8 | Rechargeable lithium battery 9Ah |
| BATLID8 | Battery compartment lid |
| LID8 | Rubber cap protecting the connector panel with Senseca logo |
| MC800 | Precision microphone (class 1) |
| MP800 | Single-range microphone preamplifier |
| WSO | Outdoor microphone protection |
| WS90 | Windshield (90 mm) for 1/2" microphones. |

18 Appendix A – Technical Specifications

| | | |
|--|---|--|
| Inputs | Microphone | MC800: Free field ½", 50 mV/Pa sensitivity; 0V; IEC 61094-4 WS2F, 3.15Hz-20KHz. MP800: preamplifier, automatic detection of model and calibration data. SDI (Sensor Digital Interface). CTC automatic electric calibration |
| Measuring ranges with MC800 microphone MP800 preamplifier | Dynamic range Linear Operating Range | > 125dB A (1kHz) 15 dB – 137 (140pk) C 18 dB – 137 (140pk) Z 23 dB – 137 (140pk) |
| Frequency weightings | | A, C + B or Z (user selection). 3 simultaneous |
| Time constants | | Fast, Slow, Impulse, Peak simultaneous |
| Averaging | | Linear, exponential, moving, max, min |
| Parameters* | | Lp, Leq, LLeq, SEL, Leq _{mov} (Sliding), L _{min/max} , L _{peak} , Level diff. (i.e. L _{Ceq} -L _{Aeq}), LUP, L _{Ueq} (User between two sel.bands), LAFT, LAFTeq (TaktMax), L _{PER} (L _{den} , L _{dn} , L _{day} , L _{evening} , L _{night}), L _p ^{1/1} , L _p ^{1/3} , Leq ^{1/1} , Leq ^{1/3} , Leq _{mov} ^{1/1} , Leq _{mov} ^{1/3} , Ln (0.1%-99.9%), Ln _{mov} , Ln ^{1/1} , Ln ^{1/3} , pL, pL ^{1/3} *For more details about measurement parameters see " Appendix B – Parameters " |
| Spectral Analysis | Octave | Real time, 1/1 octave, 8Hz to 16kHz, IEC 61260-1:2014 Real time, 1/3 octave 6.3Hz to 20kHz, IEC 61260-1:2014 |
| | FFT | Real time FFT in parallel with 1/3 oct. 2000/4000/8000/16000 lines. Span: 1200Hz, 6KHz, 24KHz with a respective min freq.resolution: 73mHz, 370mHz, 1.5Hz . Windowing: ractangular, triangular, hanning, blackman, hamming, flat-top. Averaging: Lin / Exp. Complying with ISO/TS 20065:2022 and IEC 61400-11:2012 |
| Noise Criteria | | NC, NR, RNC, RC (range 16Hz-8KHz octave) |
| Reverberation time | | T60 calculation in 1/1 oct. 63Hz-8KHz or 1/3 oct. range 50Hz-10KHz. Computation of correlation; decay linearity acc. to ISO3382:2008. Minimum T60=120ms. Background noise correction. |
| Intelligibility | | STI (STIPA method) according to IEC 60268-16:2011 |
| Statistical Analysis | | Broad band and Spectral: 7xLn (Lin and Mov) selectable percentile levels (0.1%-99.9%). Probability/Cumulative distribution |
| Audio | Recording | Mode: continuous, manual or event triggered. Resolution 16, 24, 32-bit. Audio-band: 10, 20 KHz. Format: Wave or compressed (ADPCM) |
| | Playback | Embedded codec for signal generation. Playback channels: <i>Generator</i> , <i>Trace</i> (.wav) or <i>Measurement</i> (Mic input). Playback Mic or Mic-filtered (Wide Band A, C, Aux or 1/3 band selectable) for Audio playback of microphone input. |
| Measurement Control | | Start, stop, pause, reset, back-erase, continue, event marking, manual audio recording. Measure timer from 1s to 23:59:59 hrs |
| Calibration | Acoustic | Manual or automatic (tone detection). Calibrations history: date/time, dB correction. Free Field, Random Incidence, environmental and shield corrections |
| Triggers | Broad band | Single or multiple (OR/AND) on broad-band levels, levels difference, Ln, L _{mov} |
| | Spectra | On 1/1 or 1/3 oct. masks. <i>Single</i> - All bands mode. Max, min thresholds editable (man or json file) |
| Detectors | Tonality | Automatic identification according to DM 16/03/1998 and ISO1996-2 |
| | Impulsivity | Automatic identification according to DM 16/03/1998 and ISO1996-3 |
| Storage | Physical | Embedded 4GB eMMC; USB memory stick. |
| | Cloud | Upload to cloud storage service (<i>NS-Storage</i>). Manual or automatic (Push) |
| | Archive | List and preview of stored data. Manual data upload on <i>NS-Storage</i> cloud service. |
| Datalogging | | Time history: independent Short, Standard, Report steps. Short: 10ms. Standard: 100/200/500ms/1s. Reports: 10/20/30s,1/2/5/10/20/30/60m Events: triggered broad-band, octave, Ln values Globals: Continuous, Daily integrations |

| | | |
|----------------------|--------------------|--|
| Display | | 4.3" touch, 480x800px, colour TFT, high brightness, sunlight readability. Auto brightness. |
| Keyboard | | ON/OFF/MENU key with RGB backlight; Function keys (2x); Multi-colour Status Indicator. |
| Battery | Type | Rechargeable battery pack, Li-Ion polymer, 9000mAh. PCM circuit for battery protection. Charging temperature range 0°C to 45°C |
| | Operating time | > 30h (wifi OFF) > 24h (wifi ON) |
| Wireless | Wi-Fi | Embedded Wi-Fi module (2.4GHz - IEEE 802.11 b/g/n), for web communication and time sync |
| | GSM | Embedded 4G-LTE modem module for web communication and time sync. Nano SIM slot (4FF) |
| Hardware interface | USB-C | USB-C, OTG 2.0. MS (Mass Storage) and CD (Communication Device) |
| | Ethernet | RJ45 10/100 Ethernet for web communication and time sync |
| | Aux | RJ12: auxiliary connector for external devices as Meteo stations (Meteo interface) |
| | Audio I/O | 3.5mm 4-pin audio jack: audio I/O and trigger I/O |
| Physical | | Dimensions: 304x86x38 mm. Weight: 505 g (incl. batteries). Dust and water-resistant case (IP54). Standard ¼" tripod mount thread. |
| Operating conditions | | Temperature: -10°C a 50°C; humidity: 25% al 90% R.H. Storage temperature -20°C to 60°C |
| Language | | English, Italian (others TBA) |
| System | Status bar | Battery, Wi-Fi/Lan/4G conn., Cloud conn.level, upload/dload, notifications, date/time, active storage media, remaining storage, overload/underload, audio recording, active measurement mode |
| | Monitor | Battery level [%], device temp [°C], pressure [hPa], charge voltage, pre temp [°C] |
| | Fw/Options upgrade | Via USB connection or Over-the-air (OTA) updates of firmware and new options. |
| Acoustic Standards | IEC | Sound Level Meter IEC 61672-1 (2013) class 1 IEC 60651 (1979) plus Amendment 1 (1993-02) Amendment 2 (2000-10), type 1 IEC 60804 (2000-10) type 1 Octave and fractional octave band filters IEC 61260-1 (2014) |
| | ANSI | Sound Level Meter ANSI S1.4-1983 plus ANSI S1.4A-1985 Amendment type 1 (sound level meter) ANSI/ASA S1.4-2014 class 1 ANSI S1.43-1997 type 1 Octave and fractional octave band filters ANSI/ASA S1.11-2014 Part 1 |
| Software | Desktop | Noise Studio NS-ENS: environmental noise analysis Noise Studio NS-SIS: buildings acoustic performance analysis |
| | Web applications | Noise Studio NS-Storage: storage and display of measurement data Noise Studio NS-Manager: remote management of compatible devices Noise Studio NS-Monitor: remote management of compatible devices |

Note (for more information contact sales department):

- some hardware and firmware features may be subject to the purchase of specific options
- some features may be under development (planned) and available later (TBA)

| 4.3" color active matrix TFT display with RGB and SPI interfaces | |
|---|--|
| Panel | IPS transmissive type |
| Touch panel | 5 points + gestures |
| Size | portrait oriented 56.16 mm x 93.60 mm active area |
| Resolution | 480 x 800 pixels |
| Colors | 65K / 262K / 16.7M colors |
| Viewing quality | free viewing direction up to angles higher than 80°, bright enhancement and high reflectivity film |
| Contrast | 800 typical |
| Luminance | 600 cd/m2 typical |

| | |
|-----------------------|---|
| Readability | good even under sunlight thanks to high brightness led chips, BEF (Bright Enhancement Film) and OCA bonding |
| Cover glass | 6H tempered glass, 1.1mm thickness, OCA (Optical Clear Adhesive) glue, custom shaped with company logo |
| Mounting features | 3M VHB 5980 tape (waterproof) |
| Operating temperature | -20°C ÷ +70°C |
| Storage temperature | -30°C ÷ +80°C |
| Interfaces | RGB 16/18/24-bit and SPI |

19 Appendix B – Parameters

19.1 Measure Parameters

The acoustic parameters that can be calculated by the XPT800 sound level meter are defined in "Classes". Each Class can assume specific values of the variables "Time Constant", "Weighting", "Band" of measurement, "Type".

19.1.1 Parameters Classes

| Class | Time constant (Y)/Integration | Ponderation (X) | Band | Description |
|---------|-------------------------------|------------------|---------------------------|--|
| LXFp | FAST | A, C, AUX (Z, B) | Broadband | Sound pressure level with constant FAST |
| LXSp | SLOW | A, C, AUX (Z, B) | Broadband | Sound pressure level with constant SLOW |
| LXlp | IMP | A, AUX (B, C, Z) | Broadband | Sound pressure level with constant IMPULSE |
| LXeq | LIN | A, C, AUX (Z, B) | Broadband | Equivalent sound pressure level |
| LXeqm | LIN | A, C, AUX (Z, B) | Broadband | Equivalent sound pressure level with "moving" integration |
| LXleq | IMP | A, AUX (B, C, Z) | Broadband | Equivalent sound pressure level with constant IMPULSE |
| LXpk | NONE | C, AUX (A, B, Z) | Broadband | Peak sound pressure level |
| LXOYp | FAST, SLOW | A, C, OFF | Octave band filters | Octave band spectrum of sound pressure level. Bands from 8Hz to 16kHz |
| LXOeq | LIN | A, C, OFF | Octave band filters | Octave band spectrum of the equivalent sound pressure level. 8Hz to 16kHz Bands |
| LXOeqm | LIN | A, C, OFF | Octave band filters | Octave band spectrum of the equivalent sound pressure level with "moving" integration. 8Hz to 16kHz bands |
| LXTOYp | FAST, SLOW | A, C, OFF | Third Octave band filters | Third-octave band spectrum of sound pressure level with FAST or SLOW constant. 6.3Hz to 20kHz bands |
| LXTOeq | LIN | A, C, OFF | Third Octave band filters | Spectrum for one-third octave bands of the equivalent sound pressure level. Bands from 6.3Hz to 20kHz |
| LXTOeqm | LIN | A, C, OFF | Third Octave band filters | Spectrum for third-octave bands of the equivalent sound pressure level with "moving" integration. 6.3Hz to 20kHz Bands |
| LXfYp | EXP | - | FFT bands | FFT spectrum with EXP time constant |
| LXfeq | LIN | - | FFT bands | FFT spectrum with LIN time constant |
| LXper | per | A, C | Broadband | Equivalent sound pressure levels with Day, Evening and Night integration. Sound Levels Lden and Ldn |
| LXYn | LIN, FAST, SLOW | A, C, AUX (Z, B) | Broadband | Percentile sound pressure levels. 7 user-defined levels are calculated |
| LXYnm | LIN, FAST, SLOW | A, C, AUX (Z, B) | Broadband | Sound pressure percentile levels with "moving" integration. 7 user-defined levels are calculated |
| LXTOYn | FAST, SLOW | A, C, OFF | Third Octave band filters | Percentile sound pressure levels for third-octave spectrum bands. Seven user-defined levels are calculated |
| pLX | LIN, FAST, SLOW | A, C, AUX (Z, B) | Broadband | Sound pressure level statistics. 241 classes of 0.5dB are calculated |
| pLXTO | FAST, SLOW | A, C, OFF | Third Octave band filters | Statistics of sound pressure levels of the third-octave spectrum. 121 classes of 1.0dB are calculated |
| LUXYp | FAST, SLOW | A, C, OFF | Between two 1/3 bands | Sound pressure level integrated by the spectrum for third-octave bands, according to user-defined limits |

| Class | Time constant (Y)/Integration | Ponderation (X) | Band | Description |
|--------|-------------------------------|------------------|-----------------------|--|
| LUXeq | LIN | A, C, OFF | Between two 1/3 bands | Equivalent sound pressure level integrated from the bore for third-octave bands, according to user-defined limits. |
| LXE | LIN | A, C, AUX (Z, B) | Broadband | Exposure level (SEL) |
| LAFT | FAST | A | Broadband | Takt-max level integrated over a user-defined interval (3s or 5s) |
| LAFTeq | LIN | A | Broadband | Takt-max equivalent level |
| STI | LIN | | Octave band filters | STI index |

19.1.2 Composition of Acoustic parameters Labels

The calculated acoustic parameters, belonging to the parameter classes in the table above, are uniquely identified by labels. The same syntax is used for parameter representation in both the XPT80X sound level meter interface and the NS-Storage and NS-ENS software applications.

Description of acoustic parameter labels

| Label | Description |
|-------|--|
| L | Level |
| X | Frequency weighting filter (" " = no filter : filter = off) |
| Y | Time constant |
| TO | Third-octave band filter |
| O | Octave band filter |
| p | Sound pressure level |
| n | Statistical percentile level |
| per | Period level (day, evening, night) |
| pL | Probability of levels |
| eq | Equivalent level |
| pk | Peak level |
| E | Exposure level (SEL) |
| m | Level with moving average |
| U | User level (global level between two selectable frequency bands) |
| FT | Takt-max level |

Acoustic parameter label variables

| Type | Label | Description |
|---------|----------|---|
| INST | " " | Instantaneous sampled @ step interval |
| AVG | “,T” | Equivalent integrated in measurement time T |
| MAX | “,mx,T” | Max. in measurement time T |
| MIN | “,mn,T” | Min in measurement time T |
| INT | “,t” | Equivalent integrated in Report time interval t |
| INTMAX | “,mx,t” | Max in report time interval t |
| INTMIN | “,mn,t” | Min in report time interval t |
| EV | “,Te” | Equivalent integrated in event time interval Te |
| EVMAX | “,mx,Te” | Max in event time interval Te |
| EVMIN | “,mn,Te” | Min in event time interval Te |
| SHORT | " " | Instantaneous sampled every 10ms |
| TAKTMAX | " " | Taktmax integrated on takt interval |

Acoustic Parameter labelling example

The label that uniquely identifies the specific acoustic parameter is generated from the variables indicated above, as in the example below, where the labels of some measurement parameters are shown.

| Label | Class | Type | Time constant (Y)/Integration | Ponderation (X) | Band |
|-----------|--------|--------------|-------------------------------|-----------------|-------------------|
| LAFp | LXFp | INST | FAST | A | Broadband |
| LAeq,T | Lxeq | AVG | LIN | A | Broadband |
| Lceq,t | Lxeq | INT (Report) | LIN | C | Broadband |
| LZSp,mx,T | LXFp | MAX | SLOW | Z | Broadband |
| LZTOeq,T | LXTOeq | AVG | LIN | Z | Third Octave band |

19.1.3 Classes of measurement parameters available for visualisation

The following table shows the classes of parameters that can be displayed in the different screens available in the Graphic User Interface.

| Class | SLM | TAB WB | TAB OCT | TAB TOCT | GRAPH | HISTOGRAM | SPECTR FFT | STATISTICS | SPECTRGRAM |
|---------|-----|--------|---------|----------|-------|-----------|------------|------------|------------|
| LXFp | √ | √ | - | - | √ | - | - | - | - |
| LXSp | √ | √ | - | - | √ | - | - | - | - |
| LXlp | √ | √ | - | - | √ | - | - | - | - |
| LXeq | √ | √ | - | - | √ | - | - | - | - |
| LXeqm | √ | √ | - | - | √ | - | - | - | - |
| LXleq | √ | √ | - | - | √ | - | - | - | - |
| LXpk | √ | √ | - | - | √ | - | - | - | - |
| LXOYp | √ | - | √ | - | √ | √ | - | - | √ |
| LXOeq | √ | - | √ | - | √ | √ | - | - | √ |
| LXOeqm | √ | - | √ | - | √ | √ | - | - | √ |
| LXTOYp | √ | - | - | √ | √ | √ | - | - | √ |
| LXTOeq | √ | - | - | √ | √ | √ | - | - | √ |
| LXTOeqm | √ | - | - | √ | √ | √ | - | - | √ |
| LXfYp | - | - | - | - | - | - | √ | - | - |
| LXfeq | - | - | - | - | - | - | √ | - | - |
| LXper | √ | √ | - | - | √ | - | - | - | - |
| LXYn | √ | √ | - | - | √ | - | - | - | - |
| LXYmn | √ | √ | - | - | √ | - | - | - | - |
| LnXTOY | - | - | - | √ | - | - | - | - | - |
| pLXY | - | - | - | - | - | - | - | √ | - |
| pLXTOY | - | - | - | - | - | - | - | √ | - |
| LUXYp | √ | - | - | - | √ | - | - | - | - |
| LUXeq | √ | √ | - | - | √ | - | - | - | - |
| LXE | √ | √ | - | - | √ | - | - | - | - |
| LAFT | √ | - | - | - | √ | - | - | - | - |
| LAFTeq | √ | √ | - | - | √ | - | - | - | - |
| STIPA | √ | - | - | - | - | - | - | - | - |

19.1.4 Classes of measurement parameters available for storage

The following table shows the classes of parameters that can be logged in the different storage modes provided, corresponding to specific *.dodl files generated through the logging settings (see [9.4 Set acoustic parameters to be stored on page 69](#)).

| Class | T. HISTORY | REPORTS | EVENTS | GLOBALS |
|-------------|------------|---------|--------|---------|
| LXFp | √ | √ | √ | √ |
| LXSp | √ | √ | √ | √ |
| LXlp | √ | √ | √ | √ |
| LXeq | √ | √ | √ | √ |
| LXeqm | √ | √ | √ | √ |
| LXleq | √ | √ | √ | √ |
| LXpk | √ | √ | √ | √ |
| LXOYp | √ | √ | √ | √ |
| LXOeq | √ | √ | √ | √ |
| LXOeqm | √ | √ | √ | √ |
| LXTOYp | √ | √ | √ | √ |
| LXTOeq | √ | √ | √ | √ |
| LXTOeqm | √ | √ | √ | √ |
| LXfYp (FFT) | - | √ | √ | √ |
| LXfeq (FFT) | - | √ | √ | √ |
| LXper | √ | - | - | √ |
| LXYn | √ | √ | √ | √ |
| LXYnm | √ | - | - | - |
| LnXTOY | - | √ | √ | √ |
| pLXY | - | √ | √ | √ |
| pLXTOY | - | √ | √ | √ |
| LUXYp | √ | √ | √ | √ |
| LUXeq | √ | √ | √ | √ |
| LXE | √ | √ | √ | √ |
| LAFT | √ | - | - | - |
| LAFTeq | √ | - | - | √ |
| STIPA | - | - | - | √ |

19.1.5 Types of parameters available for screens (views)

The following table shows the types of parameters that can be displayed in the different views available in the graphical user interface.

| TYPE | SLM | TAB WB | TAB OCT | TAB TOCT | GRAPH | HISTO-GRAM | SPECTR FFT | STATI-STATICS | SPECTR-GRAM |
|---------------------|-----|--------|---------|----------|-------|------------|------------|---------------|-------------|
| INST | √ | √ | √ | √ | √ | √ | √ | - | √ |
| AVG | √ | √ | √ | √ | √ | √ | √ | √ | - |
| MAX | √ | √ | √ | √ | √ | √ | √ | - | - |
| MIN | √ | √ | √ | √ | √ | √ | √ | - | - |
| INT (Report) | - | TBA | √ | √ | - | √ | √ | √ | √ |
| INTMAX (Report max) | - | TBA | √ | √ | - | √ | √ | - | - |
| INTMIN (Report min) | - | TBA | √ | √ | - | √ | √ | - | - |
| EV (Eevent) | - | TBA | √ | √ | - | √ | √ | √ | - |
| EVMAX (Eevent max) | - | TBA | √ | √ | - | √ | √ | - | - |
| EVMIN (Eevent min) | - | TBA | √ | √ | - | √ | √ | - | - |
| SHORT | - | - | - | - | - | - | - | - | - |

19.1.6 Types of parameters available for storage

The following table shows the types of parameters that can be recorded in the different storage modes available.

| TYPE | T. HISTORY | REPORTS | EVENTS | GLOBALS |
|---------------------|------------|---------|--------|---------|
| INST | √ | - | - | - |
| AVG | √ | - | - | √ |
| MAX | √ | - | - | √ |
| MIN | √ | - | - | √ |
| INT (Report) | - | √ | - | - |
| INTMAX (Report max) | - | √ | - | - |
| INTMIN (Report min) | - | √ | - | - |
| EV (Evint) | - | - | √ | - |
| EVMAX (Evint max) | - | - | √ | - |
| EVMIN (Evint min) | - | - | √ | - |
| SHORT | √ | - | - | - |
| TAKTMAX (Tmax) | √ | - | - | √ |

19.2 Setup Parameters

The following table shows the names of the setup parameters, the menu position, the description and the range of possible values for the user setting.

| PARAMETER | MENU | DESCRIPTION/RANGE |
|---------------------|-----------------------------------|---|
| Meas. setup version | SETT.../INSTRUMENT/IDENTIFICATION | Version set-up measures |
| Instr. model | SETT.../INSTRUMENT/IDENTIFICATION | Instrument model: XPT800, XPT801 |
| Instr. serial | SETT.../INSTRUMENT/IDENTIFICATION | Instrument serial number |
| Preamplifier model | SETT.../INSTRUMENT/IDENTIFICATION | Preamplifier model: DIRECT, MP800, MP801 |
| Preamp. serial | SETT.../INSTRUMENT/IDENTIFICATION | Preamplifier serial number |
| Microphone model | SETT.../INSTRUMENT/IDENTIFICATION | Microphone model |
| Mic. serial | SETT.../INSTRUMENT/IDENTIFICATION | Microphone serial number |
| Microphone sens. | SETT.../INSTRUMENT/IDENTIFICATION | Nominal microphone sensitivity: from -80.0 to 0.0 |
| Options | SYS-INFO/FIRMWARE | Instrument options flag |
| Firmware | SYS-INFO/FIRMWARE | Instrument application firmware version |
| Standards | SYS-INFO/STANDARDS | Compliance with product standards |
| Channel | SETTINGS/INTERFACES/PLAYBACK | Playback channel: OFF, GEN, FILE, MEAS |
| Repetition | SETTINGS/INTERFACES/PLAYBACK | Playback repeat: NO, YES |
| Traces | SETTINGS/INTERFACES/PLAYBACK | Audio traces |
| Filter type | SETTINGS/INTERFACES/PLAYBACK | Playback filter: OFF, WB, TOCT |
| WB filter | SETTINGS/INTERFACES/PLAYBACK | Playback Wide Band ponderation: C, A, AUX |
| Th. octave band | SETTINGS/INTERFACES/PLAYBACK | 1/3 octave playback band: from 40Hz to 20kHz |
| AUX ponderation | SETTINGS/SOUND MEASURE/SLM | AUX ponderation: Z, B |
| U-filter MIN freq. | SETTINGS/SOUND MEASURE/SLM | Filter U - minimum frequency: from 6.3Hz to 16kHz |
| U-filter MAX freq. | SETTINGS/SOUND MEASURE/SLM | Filter U - maximum frequency: from 8Hz to 20kHz |
| Frequency | SETTINGS/INTERFACES/GEN | Generator frequency: from 5Hz to 22500Hz |
| Amplitude | SETTINGS/INTERFACES/GEN | Generator amplitude: from 0 to 1 |
| Duration | SETTINGS/INTERFACES/GEN | Generator duration: from 1s to 10s |
| Files | SETTINGS/INTERFACES/GEN | Generated traces |
| Spectrum pond. | SETTINGS/SOUND MEASURE/SPECTRA | Spectrum ponderation: OFF, C, A |
| Lpk auxil. pond. | SETTINGS/SOUND MEASURE/SLM | Lpk Auxiliary ponderation: A, AUX |
| Llp auxil. pond. | SETTINGS/SOUND MEASURE/SLM | Llp Auxiliary ponderation: C, AUX |
| Spectrum order | SETTINGS/SOUND MEASURE/SPECTRA | Spectrum bands order: 1, 3 |

| PARAMETER | MENU | DESCRIPTION/RANGE |
|---------------------|----------------------------------|--|
| Spectrum constant | SETTINGS/SOUND MEASURE/SPECTRA | Spectrum time constant: FAST, SLOW |
| Inst. param. mode | SETTINGS/SOUND MEASURE/SLM | Instantaneous parameters sampling mode: MAX, MIN, FIRST, MID, LAST |
| Display touch | SETTINGS/INTERFACES/DISPLAY | Touch controller: OFF, ON |
| Ping address | SETTINGS/INTERFACES/NETS/ | Ping address |
| Cloud address | SETTINGS/INTERFACES/NETS/ | Cloud address |
| NTP service | SETTINGS/INTERFACES/NETS/ | Connection to NTP service NTP: OFF, ON |
| NTP address | SETTINGS/INTERFACES/NETS/ | NTP address |
| Battery voltage | SYS-INFO/MONITOR | Battery voltage: from 2.5V to 4.5V |
| Battery level | SYS-INFO/MONITOR | Battery level: from 0.0% to 100.0% |
| Temperature | SYS-INFO/MONITOR | Internal temperature: from -99.9 to 99.9 |
| Pressure | SYS-INFO/MONITOR | Static pressure: from 500hPa to 1500hPa |
| Battery charger | SYS-INFO/MONITOR | Battery charging status: OFF, ON, DONE |
| Charge voltage | SYS-INFO/MONITOR | Charge voltage: from 0V to 48V |
| Preamplifier temp. | SYS-INFO/MONITOR | Preamplifier temperature: da -99.9 a 99.9 |
| Ln1 | SETT.../SOUND MEASURE/STATISTICS | Percentile Level Ln1: from 0.1% to 99.9% |
| Ln2 | SETT.../SOUND MEASURE/STATISTICS | Percentile Level Ln2: from 0.1% to 99.9% |
| Ln3 | SETT.../SOUND MEASURE/STATISTICS | Percentile Level Ln3: from 0.1% to 99.9% |
| Ln4 | SETT.../SOUND MEASURE/STATISTICS | Percentile Level Ln4: from 0.1% to 99.9% |
| Ln5 | SETT.../SOUND MEASURE/STATISTICS | Percentile Level Ln5: from 0.1% to 99.9% |
| Ln6 | SETT.../SOUND MEASURE/STATISTICS | Percentile Level Ln6: from 0.1% to 99.9% |
| Ln7 | SETT.../SOUND MEASURE/STATISTICS | Percentile Level Ln7: from 0.1% to 99.9% |
| Language | SETTINGS/INSTRUMENT/SYSTEM/ | GUI Language: ITALIAN, ENGLISH |
| Back-erase step | SETTINGS/SOUND MEASURE/SLM | Back-erase time interval: 2s, 5s, 10s, 20s |
| Day periods | SETTINGS/SOUND MEASURE/SLM | Daily Periods: dn, den |
| Period limits | SETTINGS/SOUND MEASURE/SLM | Daily Periods Time Limits |
| Period weights | SETTINGS/SOUND MEASURE/SLM | Deily Periods Weights |
| Integration | SETT.../SOUND MEASURE/STATISTICS | WB Levels Statistics time constant: LIN, FAST, SLOW |
| Ponderation | SETT.../SOUND MEASURE/STATISTICS | WB ponderation: C, A, AUX |
| Spectrum statistics | SETT.../SOUND MEASURE/STATISTICS | Spectrum for statistics: OFF, REPORT, EVENT, GLOBAL |
| Sp. stat. integr. | SETT.../SOUND MEASURE/STATISTICS | Spectrum statistics integration: LIN, EXP |
| HISTORY interval | SETTINGS/DATALOGGER/SETUP/ | Inst. History interval: 10ms, 100ms, 200ms, 500ms,1s |
| Audio logging | SETTINGS/DATALOGGER/AUDIO/ | Audio recording mode: OFF, CONT, TRG |
| Audio resolution | SETTINGS/DATALOGGER/AUDIO/ | Resolution of audio records:16, 24, 32 bit |
| Sampling rate | SETTINGS/DATALOGGER/AUDIO/ | Sampling of audio records: 12kSmp/s, 20kSmp/s |
| Audio format | SETTINGS/DATALOGGER/AUDIO/ | Audio files format: WAVE, ADPCM |
| Metrology firmware | SYS-INFO/FIRMWARE | Metrology firmware version |
| Maximum duration | SETTINGS/DATALOGGER/AUDIO/ | Maximum audio record duration: INF, 10s, 30s, 1m, 2m, 5m, 10m, 30m, 1h |
| Measure name | SETTINGS/DATALOGGER/SETUP/ | Measure name |
| Log file max size | SETTINGS/DATALOGGER/SETUP/ | Max logging file size: 1MB, 2MB, 5MB, 10MB, 20MB, 50MB, 100MB |
| Log synchronization | SETTINGS/DATALOGGER/SETUP/ | Logged Data cloud synchronization: NO, YES |
| Sync files | SETTINGS/DATALOGGER/SETUP/ | Files to be synchronized |
| Measure timer | SETTINGS/SOUND MEASURE/SETUP/ | Measurement Timer |
| Start of REPORTS | SETTINGS/DATALOGGER/SETUP/ | Reports intervals time alignment: MANUAL, CLOCK |
| Display timer | SETTINGS/INTERFACES/DISPLAY | Display backlight timer:1m, 2m, 5m, 10m, 30m, 1h |
| IP address | SYS-FUNC/NETWORK.../MONITOR | Net connection address |
| dB resolution | SETTINGS/SOUND MEASURE/SETUP/ | dB levels resolution: 0.1dB, 0.01dB |
| Pre-trigger dur. | SETTINGS/TRIGGER/SETUP | Audio recording pre-trigger duration: from 2s to 10s |

| PARAMETER | MENU | DESCRIPTION/RANGE |
|---------------------|--------------------------------|---|
| Min trigger dur. | SETTINGS/TRIGGER/SETUP | Post-trigger duration: from 1 to 3600s |
| TRGOUT polarity | SETTINGS/TRIGGER/TRGIO | TRGOUT polarity: POS, NEG |
| TRGIN polarity | SETTINGS/TRIGGER/TRGIO | TRGIN polarity: POS, NEG |
| TRGOUT mode | SETTINGS/TRIGGER/TRGIO | Modo TRGOUT: OFF, MEAS, TRG |
| Colors theme | SETTINGS/INTERFACES/DISPLAY | GUI color theme: DARK, LIGHT |
| Date | SYS-FUNC/CALIBRATION/SETUP/ | Calibration Date |
| Time | SYS-FUNC/CALIBRATION/SETUP/ | Calibration Time |
| Electric cal. date | SYS-FUNC/CALIBRATION/SETUP/ | Electric calibration date |
| Electric cal. time | SYS-FUNC/CALIBRATION/SETUP/ | Electric calibration time |
| Acoustic field | SYS-FUNC/CALIBRATION/SETUP/ | Acoustic Filed: FF, RI |
| Overload level | SETTINGS/SOUND MEASURE/SETUP/ | Overload level: from 20.0 to 199.0 dB |
| Correction | SYS-FUNC/CALIBRATION/SETUP/ | Calibration correction: from -199.0 to 199.0 dB |
| Level | SYS-FUNC/CALIBRATION/SETUP/ | Calibration Level: from 74.00 to 134.00 dB |
| Electric cal. corr. | SYS-FUNC/CALIBRATION/SETUP/ | Elec. Calibration correction: from -199.0 to 199.0 dB |
| Electric cal. level | SYS-FUNC/CALIBRATION/SETUP/ | Electric calibration level: from 74.00 to 134.00 dB |
| Calibration mode | SYS-FUNC/CALIBRATION/SETUP/ | Calibration mode: MAN, AUTO |
| El. calibration | SYS-FUNC/CALIBRATION/SETUP/ | Electric calibration: OFF, ON |
| Electric cal. timer | SYS-FUNC/CALIBRATION/SETUP/ | El. Calibration Timer: OFF or from 1h to 24h |
| TAKT step | SETTINGS/SOUND MEASURE/SLM | TAKT interval: 3s/5s |
| Integr. Threshold | SETTINGS/SOUND MEASURE/SLM | Threshold of values used for integration 0.0 to 199.9 |
| Sp. rating type | SETTINGS/SOUND MEASURE/SPECTRA | Spectrum Rating: NC, RNC, NR, RC |
| Noise rating mode | SETTINGS/SOUND MEASURE/SPECTRA | Rating mode: OFF, RATING |
| Net address mask | SETTINGS/INTERFACES/NETS/ | Manual address: address mask |
| Gateway address | SETTINGS/INTERFACES/NETS/ | Manual address: gateway |
| DNS address | SETTINGS/INTERFACES/NETS/ | Manual address: DNS |
| Preamplifier heater | SETTINGS/SOUND MEASURE/SETUP/ | Preamplifier heater: OFF, ON |
| Microphone input | SYS-FUNC/CALIBRATION/SETUP/ | Microphone input: MIC, DIRECT |
| Environmental corr. | SYS-FUNC/CALIBRATION/SETUP/ | Environmental correction: OFF, ON |
| Shield correction | SYS-FUNC/CALIBRATION/SETUP/ | Windshield correction: OFF, WS90 |
| Conn.net addr. mask | SYS-FUNC/NETWORK.../MONITOR | Net connection mask |
| Connected gateway | SYS-FUNC/NETWORK.../MONITOR | Net connection gateway address |
| Connected DNS | SYS-FUNC/NETWORK.../MONITOR | Net connection DNS address |
| GUI firmware | SYS-INFO/FIRMWARE | GUI firmware version |
| WiFi firmware | SYS-INFO/FIRMWARE | WiFi firmware version |
| Sync. backlog | SETTINGS/DATALOGGER/SETUP/ | List of files waiting for synchronization |

20 Appendix C – Trigger

The trigger function can be managed through parameters which can be set either in EDIT APP > TRIGGER or in the SETTINGS > TRIGGER menu. With this function, it is possible to automatically isolate a sound event during measurement, by identifying a change in sound level or by synchronising with an external signal or manually by pressing a button. The acoustic descriptors used by the trigger function are those selectable in the SLM view (see “9.3 Select acoustic parameters to be displayed” on page 68). The level change that triggers the event identification can be either positive or negative, and the trigger threshold can be set to a different level from the deactivation threshold. The following image shows an example of sound event capture with positive polarity. The sound level (LAeq) exceeds the set activation threshold at the time indicated by cursor V2 and then the stop threshold at the time indicated by cursor V3.

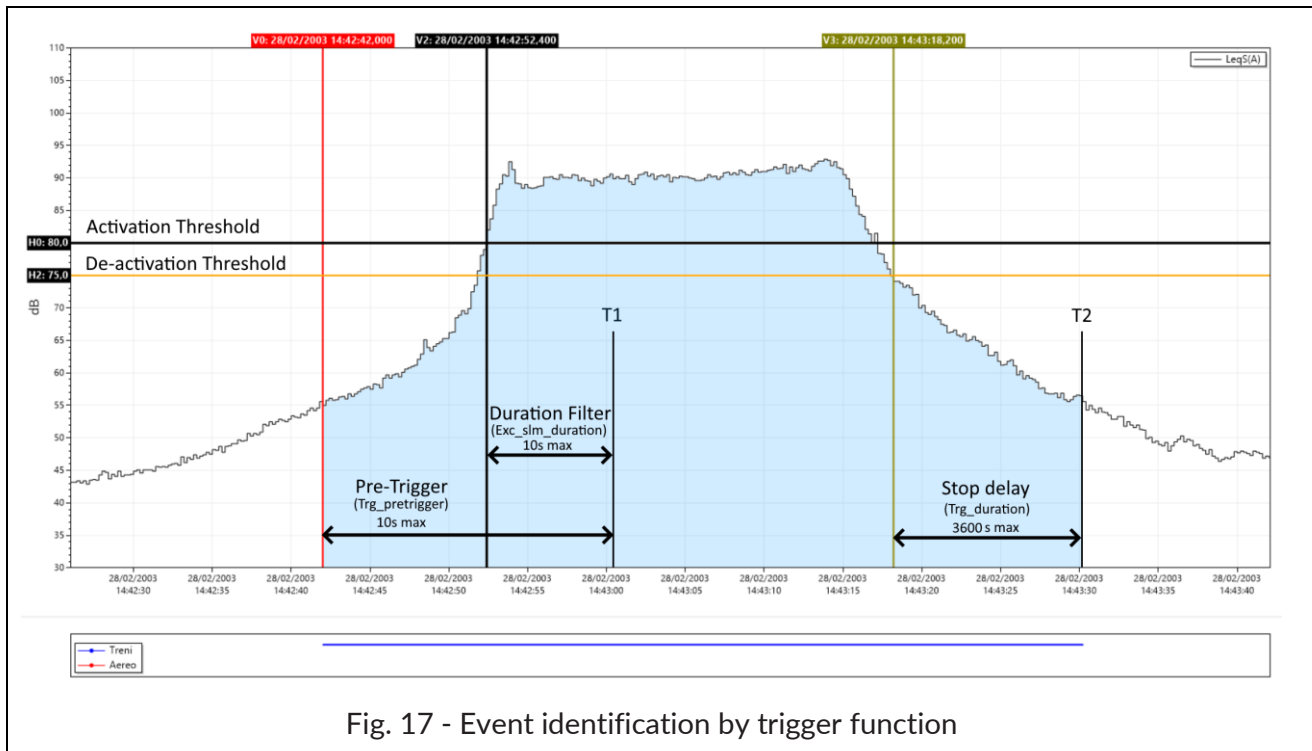

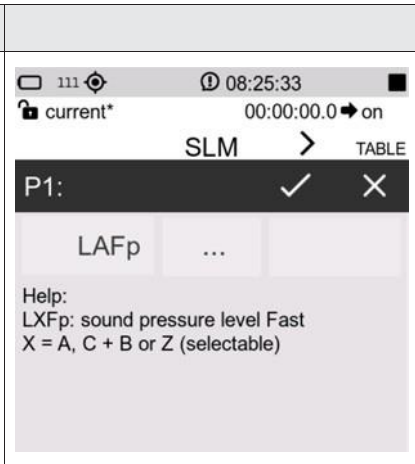

Fig. 17 - Event identification by trigger function

To prevent even short pulses from being identified as sound events, a **minimum activation duration** (duration filter) of up to a maximum of 10s can be set. If the activation threshold is exceeded for less than the set time, the event is not taken into account. A **stop delay** can also be set: when the deactivation threshold is reached, the event is delayed for the set time up to a maximum of 3600s. In the example above, as the trigger conditions persist beyond the set minimum duration, i.e. at least until time T1, the action provided by the trigger function begins; this includes the seconds before the trigger threshold is exceeded (**pre-trigger**). The pre-trigger interval can be set via the parameter Trg_pretrigger. The trigger action is terminated at time T2, with a delay equal to the stop delay starting from the instant identified by cursor V3 corresponding to the crossing of the stop threshold. The trigger to identify an event, can also be activated by means of an **electrical signal connected to the Trigger I/O input (20.5 Trigger I/O Input)** or by **pressing a button** from the interface (see 10.5 Customizing markers). In both cases the minimum duration parameter has no effect, and the event starts as soon as the trigger is detected.

20.1 Exceedances settings

One or more of the acoustic parameters set and displayed in the SLM screen can be used to trigger. The parameters selected and activated to generate the trigger will be available as input for the trigger. In the case of several activated parameters, it will be possible to combine them (OR/END logic) together to generate advanced multi-parameter triggers.

| | |
|--|---|
| <p>Tap on one of the parameters on the SLM screen to access the panel relating to the parameter on which a trigger is to be activated; from there, use the three dots  to set the relevant parameters such as the exceedance thresholds that trigger on and off, the mode and duration.</p> |  |
|--|---|

20.1.1 Exceedance of SLM parameters

Reaching the set conditions for exceedances can be used to generate a trigger. The trigger, once activated, can generate a specific action (e.g. the automatic recording of an audio signal).

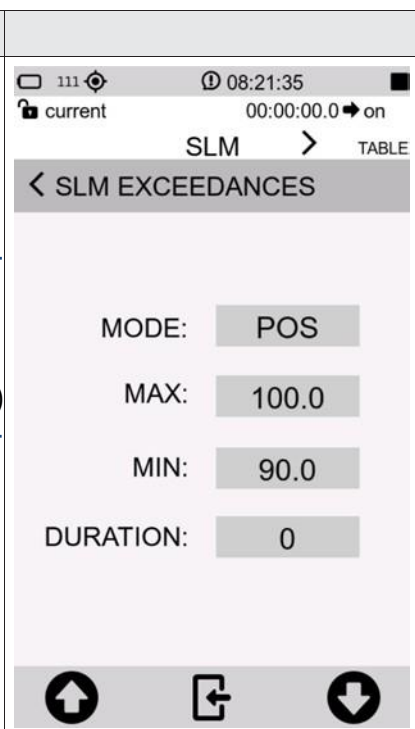
| | |
|--|---|
| <ul style="list-style-type: none"> • Set the exceedance activation MODE (see “20.1.2 Exceedance SLM mode (Exc_slm_mode)”) • Set activation threshold value (MAX) • Set deactivation threshold value (MIN) • Set minimum exceedance duration time (duration filter) for trigger activation (see “20.1.4 SLM exceedance duration filter (Exc_slm_duration)”) |  |
|--|---|

20.1.2 Exceedance SLM mode (Exc_slm_mode)

Through the MODE parameter, it is possible to trigger on SLM acoustic parameters exceedances according to 4 different modes described below. Four values are available: POS, NEG, IN, OUT

❖ POS

The exceedance occurs (trigger ON) when the sound level goes from a lower to a higher value than the Max value (threshold Max) set as the trigger activation threshold and is deactivated (trigger OFF) when the sound level goes from a higher to a lower value than the Min value (threshold Min) set as the trigger deactivation threshold.

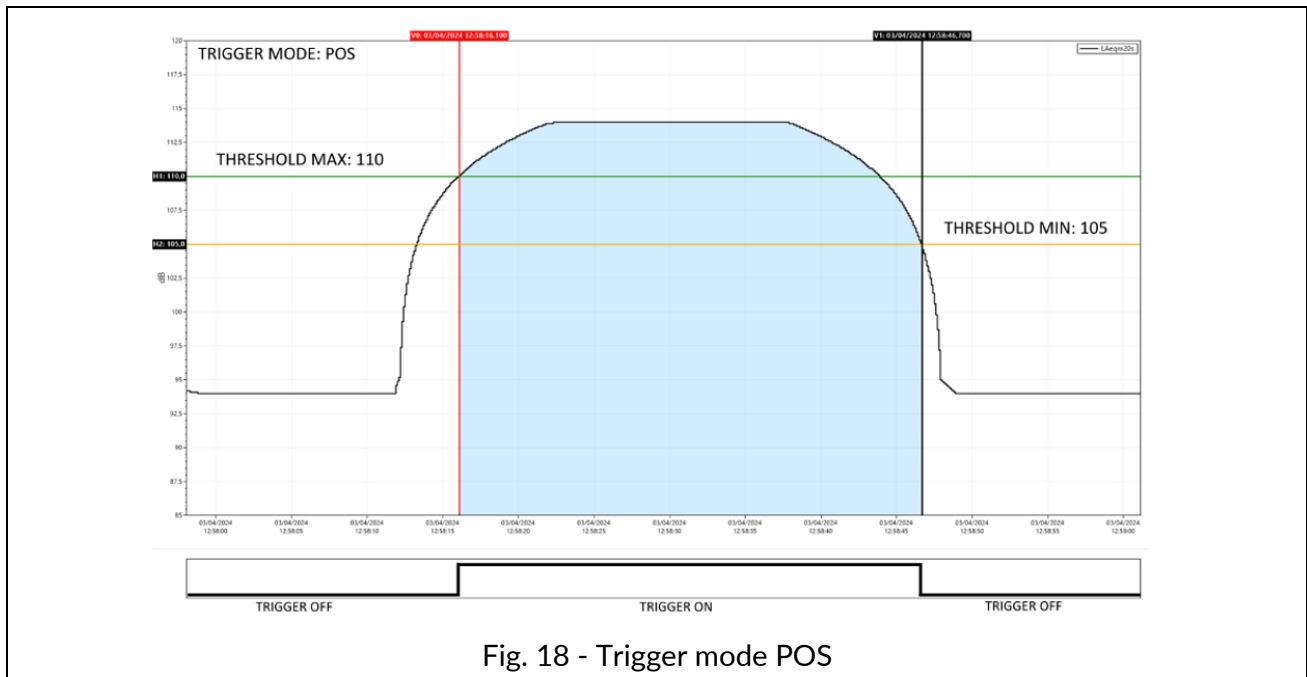

Fig. 18 - Trigger mode POS

❖ NEG

The exceedance occurs (trigger ON) when the sound level goes from a higher to a lower value than the Min (threshold Min) value set as the trigger activation threshold and is deactivated (trigger OFF) when the sound level goes from a lower to a higher value than the Max value (threshold Max) set as the trigger deactivation threshold.

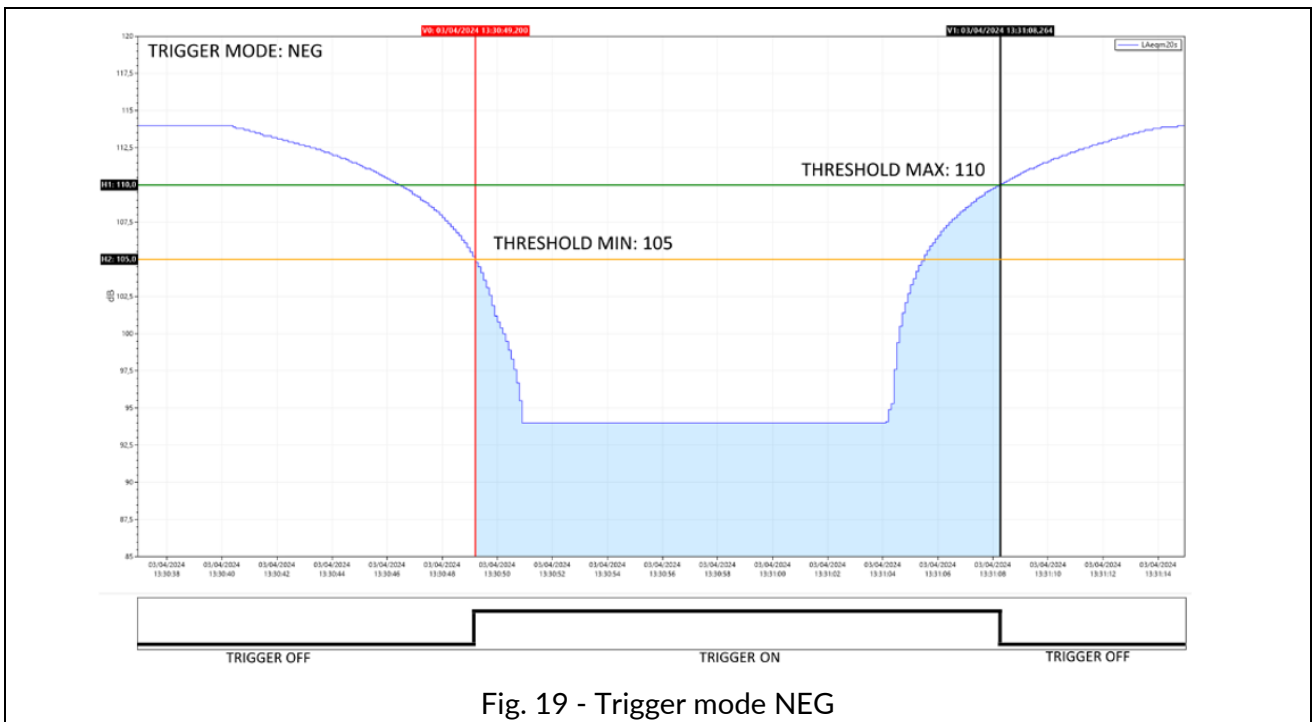
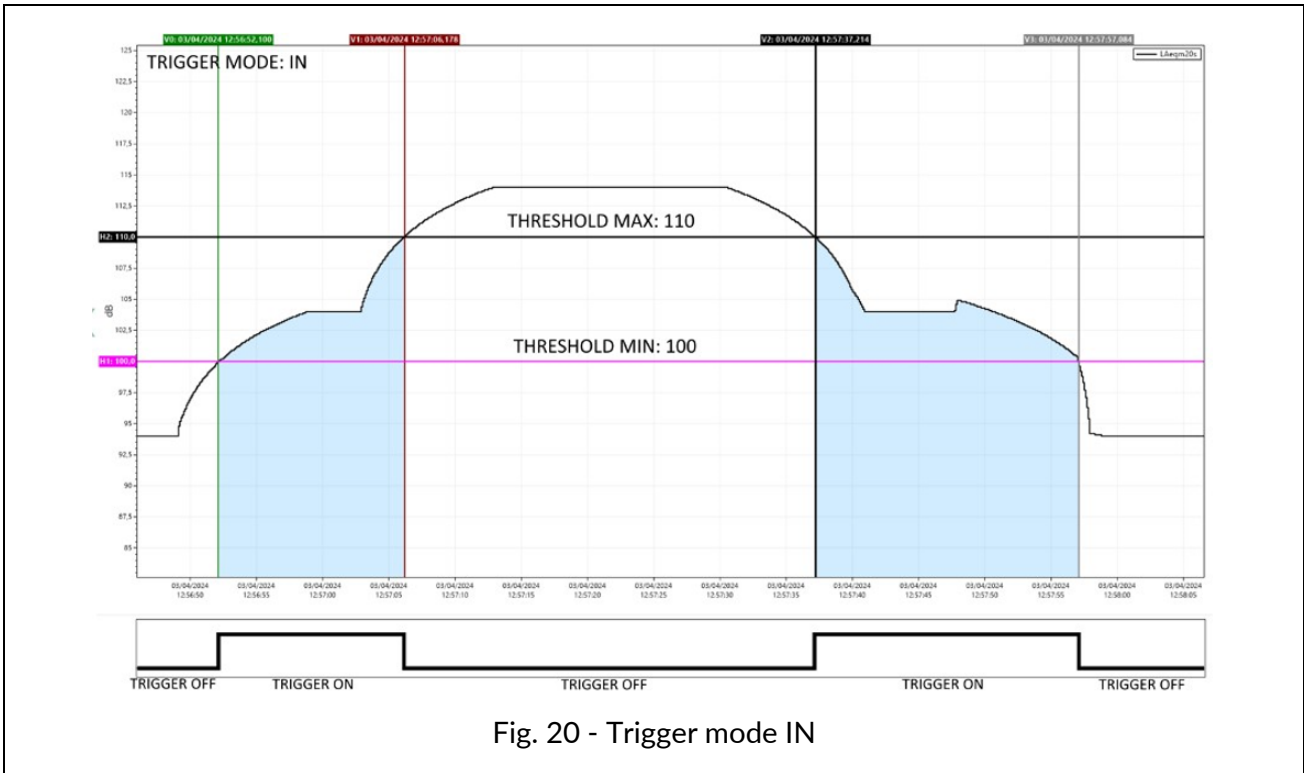

Fig. 19 - Trigger mode NEG

❖ IN

The exceedance is activated when the sound level is between the set Max (threshold Max) and Min (threshold Min) value.



❖ OUT

The exceedance is activated when the sound level is not between the set Max (threshold Max) and Min (threshold Min) value.

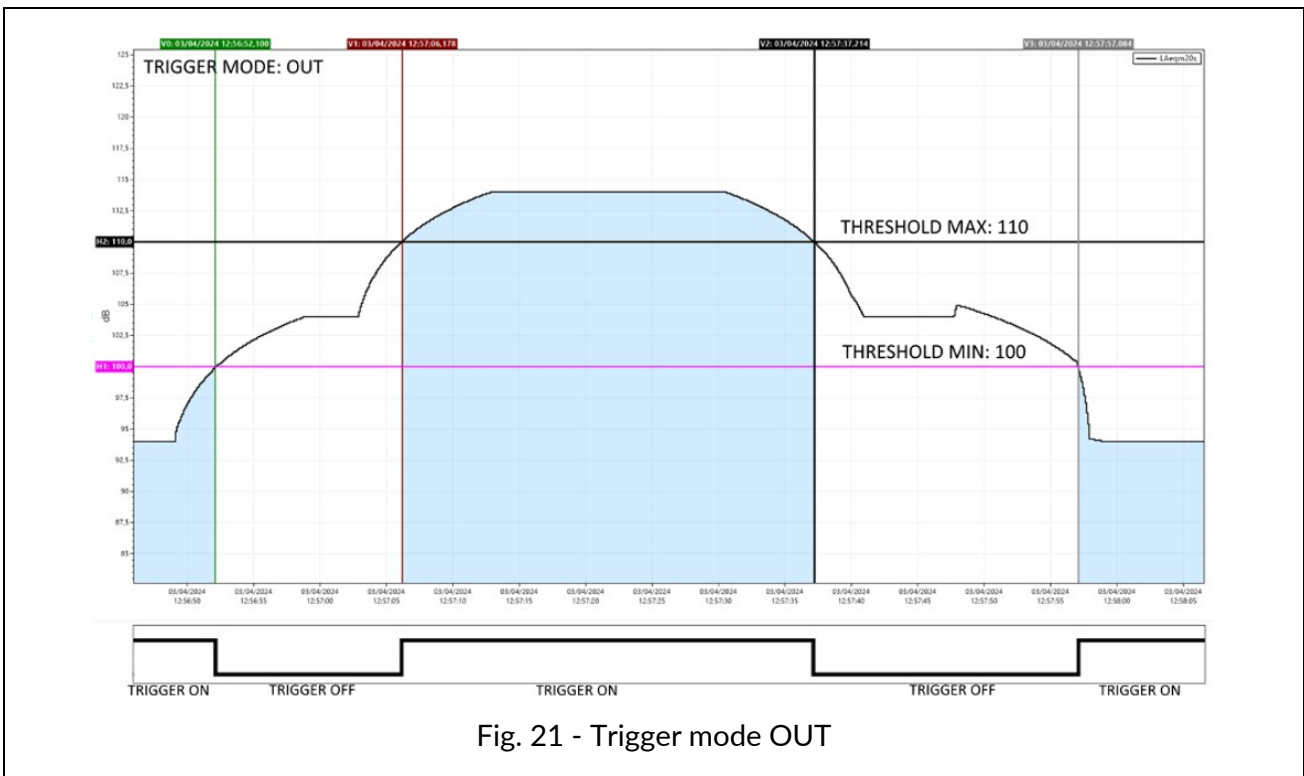

20.1.3 Exceedance SLM thresholds (Exc_slm_threshold)

User input of two level values Max and Min is required: start threshold or stop threshold depending on the selected mode (POS, NEG, IN, OUT).

Trigger start threshold: the threshold for triggering on the level reached by the selected parameter.

Trigger stop threshold: a separate deactivation threshold for triggering on the level reached by the selected parameter.

20.1.4 SLM exceedance duration filter (Exc_slm_duration)

A duration filter is available to eliminate false triggers. An event is only triggered if the over level condition persists for a number of seconds at least equal to this parameter (parameter value 0-10s).

20.1.5 Enabling SLM exceedances (Exc_slm_enable)

Enables or disables the use of exceedance on SLM (Trigger Input) parameters

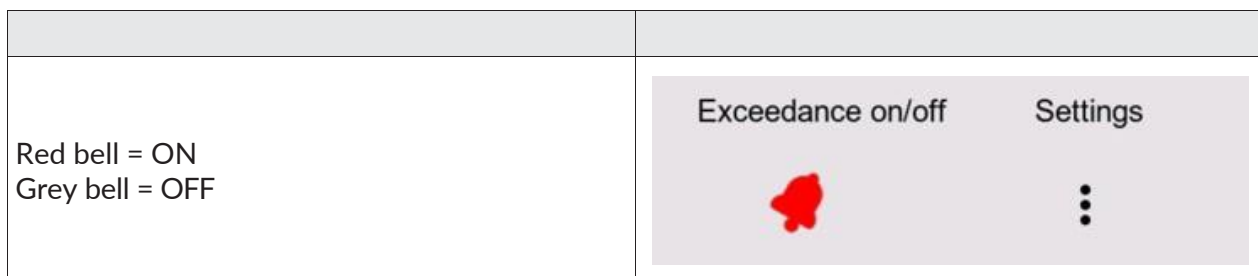

20.2 Setup trigger

(EDIT APP > TRIGGER > SETUP or SETTINGS > TRIGGER > SETUP)

General trigger parameters are available for setting on SETUP menu

20.2.1 Pre-trigger

This is the time interval before the trigger occurrence. The event generated by the trigger activation will also include the configurable time interval before the trigger activation. The function makes it possible to also detect or include in the calculations the level increase phase of a sound event or particularly fast events whose phase before the trigger is triggered. (parameter value 2-10s)

20.2.2 Post-trigger duration

After the deactivation threshold is reached, the trigger remains active for a user-settable time. It is possible in this way, for example, to encode the 'tail' of a sound event (parameter value 1-3600s).

20.2.3 Retrigger

ON: if during an already active trigger, another trigger condition is detected, the new trigger is considered

OFF: if, during an already active trigger, another trigger condition is detected, the new trigger is discarded

20.3 INPUT

(EDIT APP > TRIGGER > INPUT)

The trigger input can be chosen from one or more of the parameters set in the SLM screen and activated for the trigger. The parameters selectable as trigger inputs are only those for which the Exceedance on/off (bell) function has been activated in the setting panel relating to the selected SLM parameter. Parameters selected as trigger inputs can be set to each other in OR or END logic.

20.3.1 SLM

The screen shows 12 parameters (among which there can also be coupled parameters of the type L1 minus L2), 6 related to Par1 and 6 related to Par 2. Only the parameters available for the trigger (Exceedance on) will be active; those not available (Exceedance off) will be visible but deactivated and in grey colour; for the latter, the selection on/off checkbox cannot be activated.

The on/off checkbox can be used to activate or deactivate the parameter for its use as a trigger during measurement.

If the logic between Par1 and Par2 is set to AND, it is possible to select one of the activated SLM parameters in Par2 for the trigger (Exceedance on). Activating the AND logic will only trigger if both Par1 and Par2 reach the values set in the exceedance panel.

20.3.2 MRK

Allows the marker name to be changed and activated by check box.

20.3.3 MIX

Trigger IN (ON/OFF): enables external trigger on Trigger I/O input

20.4 Setting exceedances of a spectrum in octave or third octave bands

The exceedance monitoring function on the octave or third-octave band spectrum allows min and max thresholds to be set for each band (spectrum exceedance mask). The exceeding of one or more bands generates a trigger.

Setting thresholds for each frequency band:

From graphic interface in EDIT APP/TRIGGER/SPECTRUM

- Select the band using the vertical cursor
- Modify the thresholds of the Min and Max fields
- click SAVE (the file *exceedances_xOCT.json* is modified and stored - see below).
- Click LOAD to load and display the mask (in orange color) with the thresholds set.

from PC

- By directly editing with text editor the file at path *XPT80x/sn./Setup/exceedances_xOCT.json* having the following format:

| Octave | Third Octave |
|--|---|
| <pre> "Octave":{ "8" [140.0,80.0] "16" [140.0,80.0] "31.5" [140.0,80.0] "63" [100.0,80.0] "125" [100.0,80.0] "250" [100.0,80.0] "500" [100.0,80.0] "1k" [100.0,80.0] "2k" [100.0,80.0] "4k" [100.0,80.0] "8k" [100.0,80.0] "16k" [100.0,80.0] </pre> | <pre> "Third Octave":{ "6.3" [140.0,80.0] "8" [140.0,80.0] "10" [140.0,80.0] "12.5" [140.0,80.0] "16" [140.0,80.0] "20" [140.0,80.0] "25" [140.0,80.0] "31.5" [140.0,80.0] "40" [100.0,80.0] "50" [100.0,80.0] "63" [100.0,80.0] "80" [100.0,80.0] "100" [100.0,80.0] "125" [100.0,80.0] "160" [100.0,80.0] "200" [100.0,80.0] "250" [100.0,80.0] "315" [100.0,80.0] "400" [100.0,80.0] "500" [100.0,80.0] "630" [100.0,80.0] "800" [100.0,80.0] "1k" [100.0,80.0] "1.25k" [100.0,80.0] "1.6k" [100.0,80.0] "2k" [100.0,80.0] "2.5k" [100.0,80.0] "3.15k" [100.0,80.0] "4k" [100.0,80.0] "5k" [100.0,80.0] "6.3k" [100.0,80.0] "8k" [100.0,80.0] "10k" [100.0,80.0] "12.5k" [100.0,80.0] "16k" [100.0,80.0] "20k" [100.0,80.0] </pre> |

20.4.1 Enabling Spectrum exceedances

From graphic interface access the spectrum view (or EDIT APP/SEL.VIEW/SPECTRUM)

- Tap the bell to access the setting
- BANDS: select SINGLE or ALL
 - SINGLE (reaching the conditions of at least one band generates the surplus)
 - ALL (reaching of exceedance conditions must be true for all bands)
- Select required MODE (see [20.1.2 Exceedance SLM mode \(Exc_slm_mode\) on page 169](#))
- Activate the exceedance switching the cursor to ON

With exceedance activated, the bell icon in the spectrum view changes from gray to white (or black depending on the display colour mode).

When the set conditions for exceedances are reached, the bell turns red  and a trigger is generated.

20.5 Trigger I/O Input

The input can be used to receive (Trigger IN) or send (Trigger OUT) electrical signals.

The input settings can be modified from SETTINGS/TRIGGER/TRGIO

20.5.1 TRGOUT polarity

Sets the polarity of the output trigger signal

POS: the polarity of the output signal is positive

NEG: the polarity of the output signal is negative

20.5.2 TRIGIN polarity

Sets the polarity of the input trigger signal

POS

IN

20.5.3 TRGOUT Mode

Sets the mode of the output trigger signal

OFF

MEAS

TRG

21 Appendix D - File system information

21.1 XPT80X_SLM_Config

The file contains information about the specific device, such as the microphone serial number. It is strongly recommended that this file is backed up; if the device is formatted, restoring the file to the file system will allow information about the device to be recovered.

The file can be found in the following path:

Memory unit:\XPT800_2404A00000\Configuration\SLM\000000000001.conf

```
"XPT80X_SLM_Config":  
"preamplifier_model": "MP800"  
"preamplifier_serial": "000000000001"  
"microphone_model": "MC800"  
"microphone_serial": "000001"  
"microphone_polarization": "OV"  
"sensitivity": "-26.0dB"  
"CIC_option": "YES"  
"HEATER_option": "YES"
```

22 Appendix E – Serial Interface

Terminal Settings

Access to the serial communication port (RS232/485 interface) is possible via the USB-C connector. To communicate with the device, set up communication as shown in the table below.

| | | |
|----------------------|--------------|--------|
| Serial communication | Speed (baud) | 115200 |
| | Data bits | 8 |
| | Stop bits | 1 |
| | Parity | none |
| | Flow control | none |

XPT80x measurement status and status transitions

| Status | Description |
|--------|---|
| Stop | The instrument does not perform new sound level measurements. The screens show the last measured level. |
| Run | The instrument performs sound level measurements. The screens show the measurement levels updated every 0.5s. |
| Log | The instrument takes sound level measurements and stores them according to the setup set by the user. The screens show the measurement levels updated every 0.5s. |

| Command | Initial status | Final status |
|----------|----------------|--------------|
| RUN | Stop | Run |
| LOG | | Log |
| STOP | Run | Stop |
| PAUSE | | Pause |
| LOG | Log | Stop |
| CONTINUE | Pause | Run |

22.1 COM commands

| Command (FW V.0525V165) | Answer | Description |
|----------------------------|---|---|
| ? | PAR CMD | Requests command list: - PAR: command to read the values measured by the instrument - CMD: measurement control command |
| PAR:? | SLM SLM2 SPC | Prompts for PAR command parameter list: - SLM: group consisting of the last 3 measurement parameters of the SLM screen - SLM2: group consisting of the first 3 measurement parameters of the SLM screen - SPC: instantaneous spectrum per octave band or third octave |
| CMD:? | STOP RESET RUN PAUSE CONTINUE | Prompts for CMD command parameter list: - STOP: stops measurement; instrument enters Stop state (execute only while instrument is in Run or Log state) - RESET: resets the integrated measurement parameters (only execute while the instrument is in Pause status) - RUN: resets the measurement parameters and starts a new measurement; the instrument enters the Run state (execute only while the instrument is in the Stop state) - PAUSE: suspends the integration of the global measurement parameters; the instrument enters the Pause state (execute only while the instrument is in the Run state) - CONTINUE: resumes integration of global measurement parameters; the instrument returns to the Run state (execute only while the instrument is in the Pause state) - LOG: resets the measurement parameters and starts a new measurement; the instrument enters the Log state (execute only while the instrument is in the Stop state) |
| PAR:SLM:0:? | LAFp= 55.9;LCFp= 58.4;LZFP= 62.2 | Prompts the reading of all values in the SLM group. In the response example, the SLM group measurement levels are: - LAFp = 55.9 dB - LCFp = 58.4 dB - LZFP = 62.2 dB". |

| | | |
|--------------|---|--|
| PAR:SLM:2:? | LCFp= 60.7 | Prompts the reading of the 2nd value of the SLM group. In the response example the 2nd measurement level of the SLM group is: LCFp = 60.7 dB. |
| PAR:SLM2:0:? | LASp= 52.2;LCSp= 56.8;LZSp= 59.2 | Prompts the reading of all values in the SLM2 group. In the response example, the SLM group measurement levels are: - LASp = 52.2 dB - LCSp = 56.8 dB - LZSp =59.2 dB |
| PAR:SPC:0:? | LTOFp= 55.5, 57.4, 55.1, 52.3, 53.1, 47.9, 50.5, 51.4, 45.3, 46.7, 46.4, 48.7, 41.7, 44.6, 44.7, 46.2, 45.7, 48.3, 47.6, 44.4, 46.6, 48.0, 54.3, 51.8, 47.7, 46.0, 46.3, 48.0, 45.8, 46.8, 45.2, 38.9, 37.9, 31.5, 33.5, 27.9 | Prompts for a reading of the instantaneous spectrum. In the response example, the third-octave spectrum of the LFp parameter is given. For the XPT800 the bands are 36 starting at 6.3Hz while for the XPT801 the spectrum bands are 31 starting at 20Hz. |
| PAR:SPC:1:? | LTO6.3Fp= 57.2 | Prompts for a reading of the 1st band of the instantaneous spectrum. The response example gives the instantaneous sound level of the 1st band of the spectrum per third octave of the LFp parameter: LTO6.3Fp = 57.2dB For the XPT800 the bands are 36 starting at 6.3Hz while for the XPT801 the bands of the spectrum are 31 starting at 20Hz. |

23 Declaration of Conformity



DICHIARAZIONE DI CONFORMITÀ UE EU DECLARATION OF CONFORMITY

Senseca Italy S.r.l. | Via Marconi, 5 | 35030 Selvazzano Dentro (PD) | ITALY

Documento Nr. / Mese.Anno: **5214 / 05.2024**
Document-No. / Month.Year:

Si dichiara con la presente, in qualità di produttore e sotto la propria responsabilità esclusiva, che i seguenti prodotti sono conformi ai requisiti di protezione definiti nelle direttive del Consiglio Europeo:

We declare herewith under our sole responsibility that the following products are in compliance with the protection requirements defined in the European Council directives:

Codice prodotto: **XPT800**
Product identifier:

Descrizione prodotto: **Fonometro**
Product description: **Sound level meter**

I prodotti sono conformi alle seguenti Direttive Europee:
The products conform to following European Directives:

| Direttive / Directives | |
|--------------------------|---|
| 2014/53/EU | Direttiva apparecchiature radio / <i>Radio Equipments Directive (RED)</i> |
| 2011/65/EU - 2015/863/EU | RoHS |

Norme armonizzate applicate o riferimento a specifiche tecniche:
Applied harmonized standards or mentioned technical specifications:

| Norme armonizzate / <i>harmonized standards</i> | |
|---|---|
| EN 61326-1:2021 | EMC - Prescrizioni generali / <i>General requirements</i> |
| EN 61326-2-3:2021 | EMC - Prescrizioni particolari / <i>Particular requirements</i> |
| EN 62479:2010 | Esposizione umana a campi elettromagnetici / <i>Human exposure to EMF</i> |
| ETSI EN 301 489-1 V2.1.1 | EMC - Dispositivi radio / <i>Radio equipments</i> |
| ETSI EN 301 489-17 V3.1.1 | EMC - Dispositivi RF a banda larga / <i>RF broadband devices</i> |
| ETSI EN 300 328 V2.1.1 | Dispositivi RF a banda larga / <i>RF wideband devices</i> |
| EN 61010-1:2010/A1/AC:2019 | Requisiti di sicurezza elettrica / <i>Electrical safety requirements</i> |
| EN IEC 63000:2018 | RoHS |

Il produttore è responsabile per la dichiarazione rilasciata da:
The manufacturer is responsible for the declaration released by:

Gianluca Maestroni
VP Environmental BU

Selvazzano Dentro, 14/05/2024

Questa dichiarazione certifica l'accordo con la legislazione armonizzata menzionata, non costituisce tuttavia garanzia delle caratteristiche.

This declaration certifies the agreement with the harmonization legislation mentioned, contained however no warranty of characteristics.

WARRANTY

The manufacturer is required to respond to the "factory warranty" only in those cases provided by Legislative Decree 6 September 2005 - n. 206. Each instrument is sold after rigorous inspections; if any manufacturing defect is found, it is necessary to contact the distributor where the instrument was purchased from. During the warranty period (24 months from the date of invoice) any manufacturing defects found will be repaired free of charge. Misuse, wear, neglect, lack or inefficient maintenance as well as theft and damage during transport are excluded. Warranty does not apply if changes, tampering or unauthorized repairs are made on the product. Solutions, probes, electrodes and microphones are not guaranteed as the improper use, even for a few minutes, may cause irreparable damages. The manufacturer repairs the products that show defects of construction in accordance with the terms and conditions of warranty included in the manual of the product. For any dispute, the competent court is the Court of Padua. The Italian law and the "Convention on Contracts for the International Sales of Goods" apply.

TECHNICAL INFORMATION

The quality level of our instruments is the result of the continuous product development. This may lead to differences between the information reported in the manual and the instrument you have purchased. We reserve the right to change technical specifications and dimensions to fit the product requirements without prior notice.

DISPOSAL INFORMATION

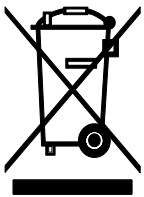

Electrical and electronic equipment marked with specific symbol in compliance with 2012/19/EU Directive must be disposed of separately from household waste. European users can hand them over to the dealer or to the manufacturer when purchasing a new electrical and electronic equipment, or to a WEEE collection point designated by local authorities. Illegal disposal is punished by law.

Disposing of electrical and electronic equipment separately from normal waste helps to preserve natural resources and allows materials to be recycled in an environmentally friendly way without risks to human health.



RoHS

senseca.com



Senseca Italy S.r.l.
Via Marconi, 5
35030 Selvazzano Dentro (PD)
ITALY
info@senseca.com

