



KERN & Sohn GmbH

Ziegelei 1
D-72336 Balingen
E-Mail: info@kern-sohn.com

Tel: +49-[0]7433- 9933-0
Fax: +49-[0]7433-9933-149
Internet: www.kern-sohn.com

Operating instructions Precision/ compact balances and platform scales

KERN 572 / 573 / KB / DS / FKB

Version 7. 4
2017-10
GB



572/573/KB/DS/FKB -BA-e-1774

Importør:
Impex Produkter AS
Gamle Drammensvei 107
1363 HØVIK
Tel. 22 32 77 20
info@impex.no
www.impex.no



KERN 572 / 573 / KB / DS / FKB

Version 7.4 2017-10

Operating instruction

Precision/compact balances and platform scales

Table of contents:

1	MODE - MENUE	4
2	Technical data	6
2.1	KERN 572.....	6
2.2	KERN 573.....	9
2.3	KERN KB	10
2.4	KERN DS.....	14
2.5	KERN FKB	18
3	Fundamental information (general).....	21
3.1	Intended use.....	21
3.2	Inappropriate use.....	21
3.3	Monitoring the test substances	21
4	Fundamental safety information.....	22
4.1	Observe the information in the operating instructions	22
4.2	Staff training.....	22
5	Transport and storage	22
5.1	Acceptance check	22
5.2	Packaging.....	22
6	Unpacking, installation and commissioning	23
6.1	Place of installation, place of use	23
6.2	Unpacking	23
6.2.1	Installation.....	23
6.3	Mains supply	23
6.4	Battery operation FKB.....	24
6.5	Connecting peripheral equipment	24
6.6	Initial start-up	24
6.7	Adjustment	24
6.8	Adjusting (go to 7.2.6)	25
6.8.1	Adjusting for verification (KERN 573; FKB-M; KB-NM; DS-M).....	25
6.9	Verification	26

7	Operation	27
7.1	Display control panel	27
7.2	Operation	29
7.2.1	Weighing with Tare	29
7.2.2	Count – Selection reference piece	29
7.2.3	Percent %	29
7.2.4	Formula Weighing	29
7.2.5	Tolerance Weighing	29
7.2.6	Adjust	31
7.2.7	Preselect Tare	31
7.2.8	Auto Tare active	31
7.2.9	Filter / Speed	31
7.2.10	Auto Off active	31
7.2.11	Variable Factor	31
7.2.12	Preselect Unit	31
7.2.13	Animal weighing:	33
7.2.14	Swap:	33
7.3	Display background illumination	35
7.4	Interface RS 232 C	35
7.5	RS 232 C Data output via interface RS 232 C	36
7.5.1	Description of the data transfer	37
7.5.2	Numerator	37
7.6	Printer	37
7.7	Underfloor weighing	38
8	Maintenance, upkeep, disposal	39
8.1	Cleaning	39
8.2	Maintenance, upkeep	39
8.3	Disposal	39
9	Troubleshooting	40
10	Declaration of conformity	40

1 MODE - MENUE

Models 572 / KB / DS / FKB non-verifiable:

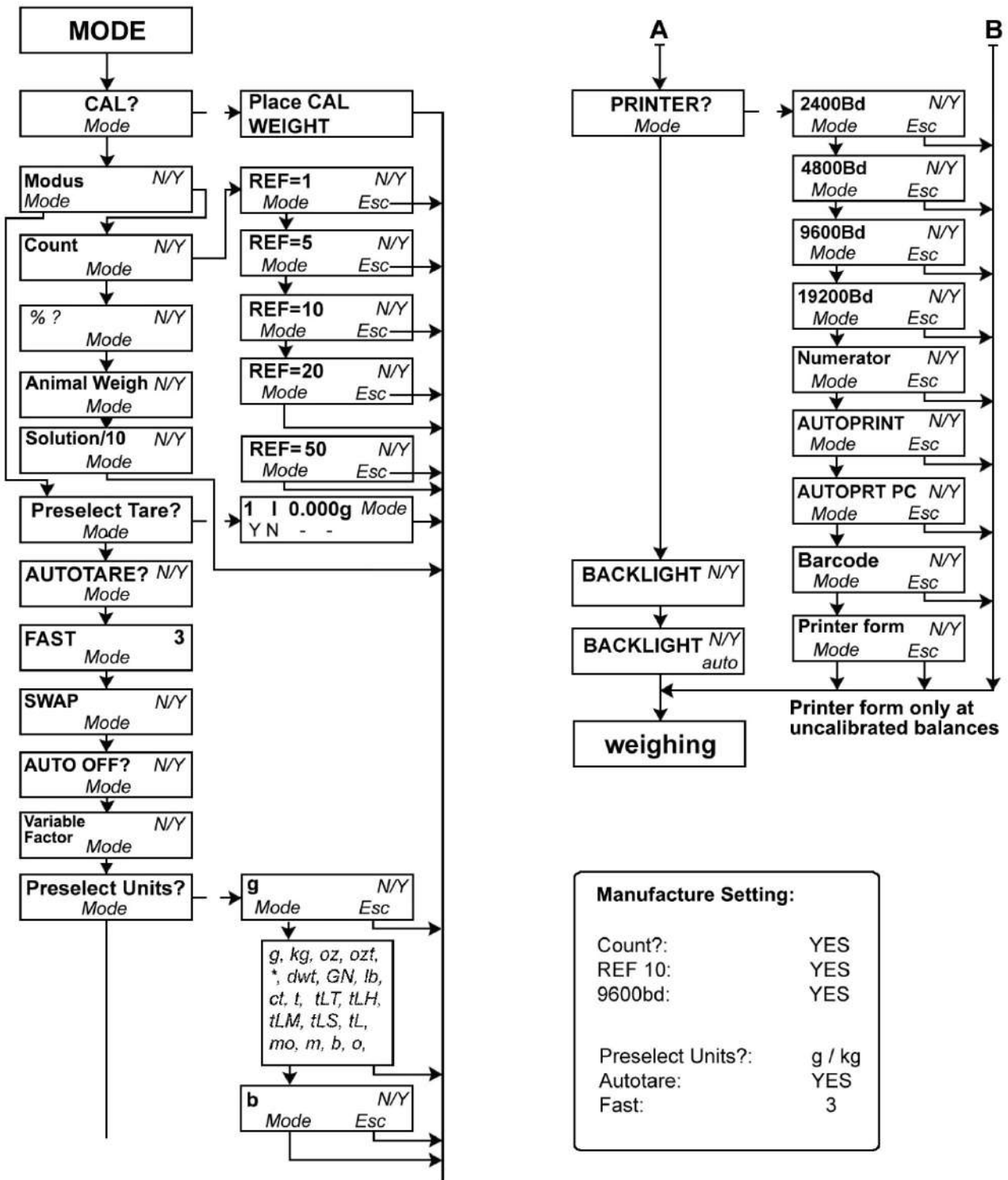

Important!

The modified settings - as well as the adjustment - must be stored when switching-off, via the ON/OFF button.

Models 573-NM; KB-NM; DS-M; FKB-M:

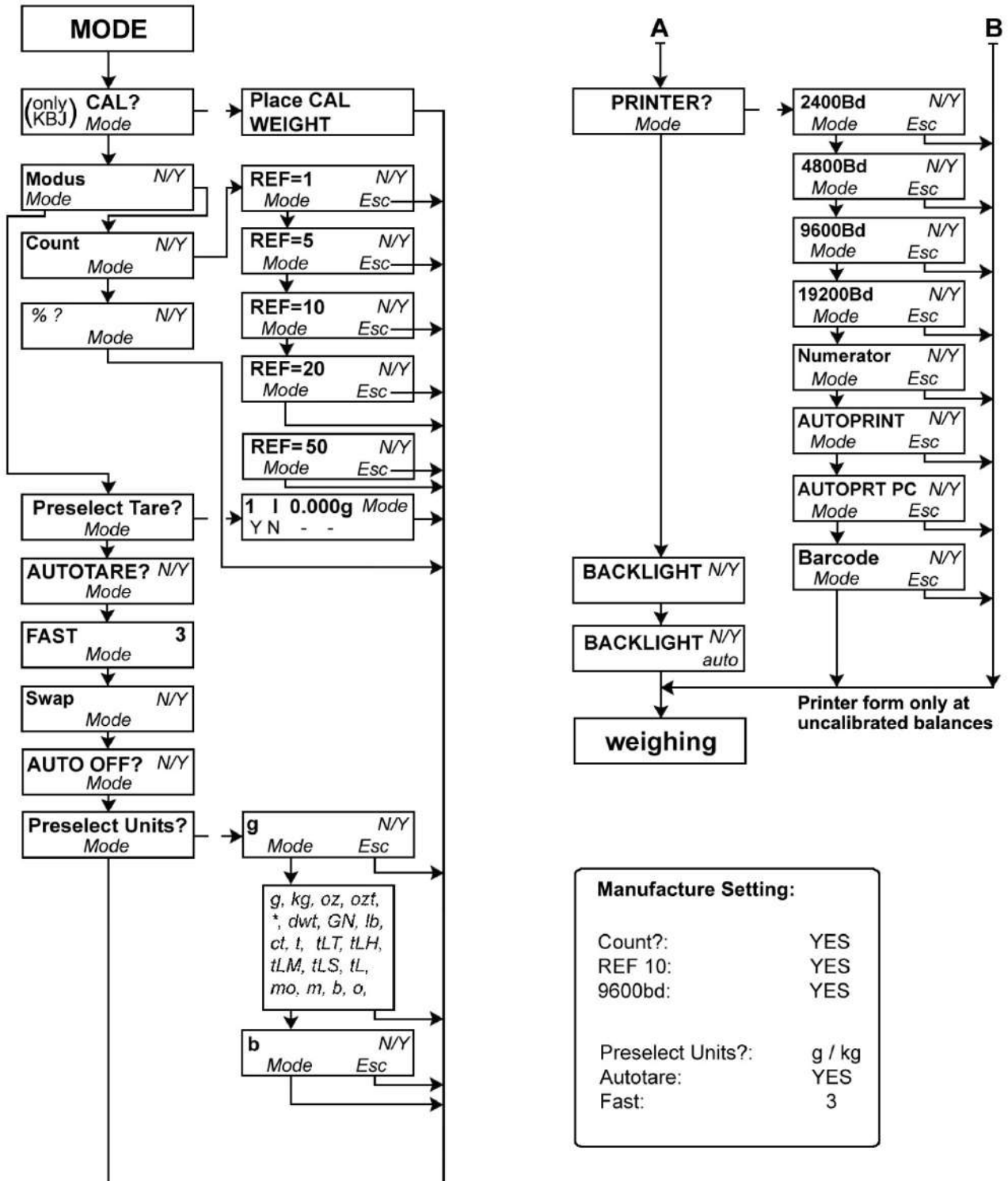

Important!

The modified settings - as well as the adjustment - must be stored when switching-off, via the ON/OFF button.

2 Technical data

2.1 KERN 572

KERN	572-30	572-31	572-32	572-33
Readability (d)	0,001 g	0,001 g	0,001 g	0,01 g
Weighing range (max)	240 g	300 g	420 g	1.600 g
Taring range (subtractive)	240 g	300 g	420 g	1.600 g
Reproducibility	0,001 g	0,002 g	0,002 g	0,01g
Linearity	±0,003 g	±0,005 g	±0,005 g	± 0,03 g
Smallest part weight for piece counting under laboratory conditions	1 mg	1 mg	1 mg	10 g
Smallest part weight for piece counting under normal conditions	10 mg	10 mg	10 mg	100 mg
Recommended adjusting weight F1 (not supplied)	200 g	200 g +100 g	200 g + 200 g	1 kg + 500 g
Adjustment points	50 g 100 g 200 g 240 g	50 g 100 g 200 g 300 g	100 g 200 g 300 g 400 g	0,5 kg 1,0 kg 1,5 kg 1,6 kg
Stabilization time (typical)	3 sec.			
Humidity of air	max. 80% relative (not condensing)			
Permitted environmental temperature	+10 °C ... + 40 °C			
Warm-up time	2 h	2 h	4 h	2 h
Housing (B x D x H) [mm]	180 x 310 x 90			
Vibration filter	yes			
Weighing plate stainless steel [mm]	Ø 106	Ø 106	Ø 106	Ø 150
Balance Input voltage	12 V, 300 mA			
Power supply unit Input voltage	100 V – 240V			
Units	see menu			
Net weight (kg)	2,3			
Interface	RS232			

KERN	572-35	572-37	572-39	572-43
Readability (d)	0,01 g	0,01 g	0,01 g	0,1 g
Weighing range (max)	2.400 g	3.000 g	4.200 g	10.000 g
Taring range (subtractive)	2.400 g	3.000 g	4.200 g	10.000 g
Reproducibility	0,01 g	0,02 g	0,02 g	0,1g
Linearity	±0,03 g	±0,05 g	±0,05 g	± 0,3 g
Smallest part weight for piece counting under laboratory conditions	10 mg	10 mg	10 mg	100 mg
Smallest part weight for piece counting under normal conditions	100 mg	100 mg	100 mg	1 g
Recommended adjusting weight F1 (not supplied)	2 kg	2 kg + 1 kg	2 kg + 2 kg	10 kg
Adjustment points	0,5 kg 1,0 kg 2,0 kg 2,4 kg	1,0 kg 1,5 kg 2,0 kg 3,0 kg	1,0 kg 2,0 kg 3,0 kg 4,0 kg	2 kg 5 kg 10 kg
Stabilization time (typical)	3 sec.			
Humidity of air	max. 80% relative (not condensing)			
Permitted environmental temperature	+10 °C ... + 40 °C			
Warm-up time	2 h	2 h	4 h	2 h
Housing (B x D x H) [mm]	180 x 310 x 90			
Vibration filter	yes			
Weighing plate stainless steel [mm]	Ø 150	Ø 150	Ø 150	160 x 200
Balance Input voltage	12 V, 300 mA			
Power supply unit Input voltage	100 V – 240V			
Units	see menu			
Net weight (kg)	2,3	2,3	2,3	2,7
Interface	RS232			

KERN	572-45	572-49	572-55	572-57
Readability (d)	0,05 g	0,1 g	0,05 g	0,1 g
Weighing range (max)	12.000 g	16.000 g	20.000 g	24.000 g
Taring range (subtractive)	12.000 g	16.000 g	20.000 g	24.000 g
Reproducibility	0,05 g	0,1 g	0,1 g	0,1g
Linearity	±0,15 g	±0,3 g	±0,25 g	± 0,3 g
Smallest part weight for piece counting under laboratory conditions	50 mg	100 mg	50	100 mg
Smallest part weight for piece counting under normal conditions	500 mg	1 g	500 mg	1 g
Recommended adjusting weight F1 (not supplied)	10 kg	10 kg + 5 kg	20 kg	20 kg
Adjustment points	2 kg 5 kg 10 kg 12 kg	5 kg 10 kg 15 kg 16 kg	5 kg 10 kg 15 kg 20 kg	5 kg 10 kg 15 kg 20 kg 24 kg
Stabilization time (typical)	3 sec.			
Humidity of air	max. 80% relative (not condensing)			
Permitted environmental temperature	+10 °C ... + 40 °C			
Warm-up time	2 h			
Housing (B x D x H) [mm]	180 x 310 x 90			
Vibration filter	yes			
Weighing plate stainless steel [mm]	160 x 200			
Balance Input voltage	12 V, 300 mA			
Power supply unit Input voltage	100 V – 240V			
Units	see menu			
Net weight (kg)	2,7			
Interface	RS232			

2.2 KERN 573

KERN	573-34A	573-34NM	573-46A	573-46NM
Readability (d)	0,01 g	0,01 g	0,1 g	0,1 g
Weighing range (max)	650 g	650 g	6.500 g	6.500 g
Taring range (subtractive)	650 g	650 g	6.500 g	6.500 g
Verification value (e)	-	0,1 g	-	1 g
Minimum load (Min)	-	0,5 g	-	5 g
Accuracy class	-	II	-	II
Reproducibility	0,01 g	0,01 g	0,1 g	0,1g
Linearity	±0,03 g	±0,03 g	±0,3 g	± 0,3 g
Smallest part weight for piece counting under laboratory conditions	10 mg	10 mg	100 mg	100 mg
Smallest part weight for piece counting under normal conditions	100 mg	100 mg	1 g	1 g
Recommended adjusting weight F1 (not supplied)	600 g	600 g	6 kg	10 kg
Adjustment points	200 g 500 g 600 g	200 g 500 g 600 g	2,0 kg 5,0 kg 6,0 kg free	2,0 kg 5,0 kg 6,0 kg free
Stabilization time (typical)	3 sec.			
Humidity of air	max. 80% relative (not condensing)			
Permitted environmental temperature	+10 °C ... + 40 °C			
Warm-up time	2 h			
Housing (B x D x H) [mm]	180 x 310 x 90			
Vibration filter	yes			
Weighing plate stainless steel [mm]	Ø 150	Ø 150	160 x 200	160 x 200
Balance Input voltage	12 V, 300 mA			
Power supply unit Input voltage	100 V – 240V			
Units	g, kg			
Net weight (kg)	2,3	2,3	2,8	2,8
Interface	RS232			

2.3 KERN KB

KERN	KB 120-3N	KB 240-3N	KB 360-3N	KB 600-2
Readability (d)	0,001 g	0,001 g	0,001 g	0,01 g
Weighing range (max)	120 g	240 g	360 g	650 g
Taring range (subtractive)	120 g	240 g	360 g	650 g
Reproducibility	0,001 g	0,001 g	0,002 g	0,01 g
Linearity	±0,003 g	±0,003 g	± 0,005 g	±0,03 g
Smallest part weight for piece counting under laboratory conditions	1 mg	1 mg	1 mg	10 mg
Smallest part weight for piece counting under normal conditions	10 mg	10 mg	10 mg	100 mg
Recommended adjusting weight F1 (not supplied)	100 g	200 g	200 g +100 g	500 g +100 g
Adjustment points	20 g 50 g 100 g 120 g	100 g 150 g 200 g 240 g	100 g 200 g 300 g 360 g	200 g 500 g 600 g
Stabilization time (typical)	3 sec.			
Humidity of air	max. 80% relative (not condensing)			
Permitted environmental temperature	+10 °C ... + 40 °C			
Warm-up time	2 h	2 h	4 h	2 h
Housing (B x D x H) [mm]	167 x 250 x 85			
Vibration filter	yes			
Weighing plate stainless steel [mm]	Ø 81			
Balance Input voltage	12 V, 300 mA			
Power supply unit Input voltage	100 V – 240V			
Units	see menu			
Net weight (kg)	1			
Interface	RS232			
Rechargeable battery pack KB-A01N	7,2 V / 2000mAh			

KERN	KB 1200-2N	KB 2000-2N
Readability (d)	0,01 g	0,01 g
Weighing range (max)	1.200 g	2.000 g
Taring range (subtractive)	1200 g	2000 g
Reproducibility	0,01 g	0,01 g
Linearity	±0,03 g	±0,03 g
Smallest part weight for piece counting under laboratory conditions	10 mg	10 mg
Smallest part weight for piece counting under normal conditions	100 mg	100 mg
Recommended adjusting weight F1 (not supplied)	1000 g	2000 g
Adjustment points	200 g 500 g 1000 g	0,5 kg 1,0 kg 1,5 kg 2,0 kg
Stabilization time (typical)	3 sec.	
Humidity of air	max. 80% relative (not condensing)	
Permitted environmental temperature	+10 °C ... + 40 °C	
Warm-up time	2h	
Housing (B x D x H) [mm]	167 x 250 x 85	
Vibration filter	yes	
Weighing plate stainless steel [mm]	130 x 130	
Balance Input voltage	12 V, 300 mA	
Power supply unit Input voltage	100 V – 240V	
Units	see menu	
Net weight (kg)	1,5	
Interface	RS232	
Rechargeable battery pack KB-A01N	7,2 V / 2000mAh	

KERN	KB 2400-2N	KB 3600-2N	KB 6000-1
Readability (d)	0,01 g	0,01 g	0,1 g
Weighing range (max)	2.400 g	3.600 g	6.500 g
Taring range (subtractive)	2400 g	3600 g	6.500 g
Reproducibility	0,01 g	0,02 g	0,1g
Linearity	±0,03 g	± 0,05 g	± 0,3 g
Smallest part weight for piece counting under laboratory conditions	10 mg	10 mg	100 mg
Smallest part weight for piece counting under normal conditions	100 mg	100 mg	1 g
Recommended adjusting weight F1 (not supplied)	2000 g	3 kg	10 kg
Adjustment points	0,5 kg 1,0 kg 2,0 kg 2,4 kg	1 kg 2 kg 3 kg 3,6 kg	2,0 kg 5,0 kg 6,0 kg free
Stabilization time (typical)	3 sec.		
Humidity of air	max. 80% relative (not condensing)		
Permitted environmental temperature	+10 °C ... + 40 °C		
Warm-up time	2 h	4 h	2 h
Housing (B x D x H) [mm]	167 x 250 x 85		
Vibration filter	yes		
Weighing plate stainless steel [mm]	Ø 81		
Balance Input voltage	12 V, 300 mA		
Power supply unit Input voltage	100 V – 240V		
Units	g, kg	g, kg, ct	g, kg
Net weight (kg)	1,8	2,0	1,7
Interface	RS232		

KERN	KB 6500-1NM	KB 10000-1N	KB 10K0.05N
Readability (d)	0,1 g	0,1 g	0,05 g
Weighing range (max)	6.500 g	10.000 g	10.000 g
Taring range (subtractive)	650 g	10.000 g	10.000 g
Verification value (e)	1 g	-	-
Minimum load (Min)	5 g	-	-
Accuracy class	II	-	-
Reproducibility	0,1 g	0,1 g	0,05 g
Linearity	±0,3 g	±0,3 g	±0,15 g
Smallest part weight for piece counting under laboratory conditions	10 mg	10 mg	50 mg
Smallest part weight for piece counting under normal conditions	1 g	1 g	500 mg
Recommended adjusting weight F1 (not supplied)	6 kg	10 kg	10 kg
Adjustment points	2,0 kg 5,0 kg 6,0 kg	2,0 kg 5,0 kg 10,0 kg	2,0 kg 5,0 kg 10,0 kg
Stabilization time (typical)	3 sec.		
Humidity of air	max. 80% relative (not condensing)		
Permitted environmental temperature	+10 °C ... + 40 °C		
Warm-up time	2 h		
Housing (B x D x H) [mm]	167 x 250 x 85		
Vibration filter	yes		
Weighing plate stainless steel [mm]	150 x 170		
Balance Input voltage	12 V, 300 mA		
Power supply unit Input voltage	100 V – 240V		
Units	see menu		
Net weight (kg)	1,7		
Interface	RS232		
Rechargeable battery pack KB-A01N	7,2 V / 2000mAh		

2.4 KERN DS

KERN	DS 3K0.01S	DS 5K0.05S	DS 8K0.05	DS 10K0.1S
Readability (d)	0,01 g	0,05 g	0,05 g	0,1 g
Weighing range (max)	3.000 g	5.000 g	8.000 g	10.000 g
Taring range (subtractive)	3.000 g	5.000 g	8.000 g	10.000 g
Reproducibility	0,02 g	0,05 g	0,05 g	0,1 g
Linearity	±0,05 g	±0,15 g	± 0,15 g	±0,3 g
Smallest part weight for piece counting under laboratory conditions	10 mg	50 mg	50 mg	100 mg
Smallest part weight for piece counting under normal conditions	100 mg	500 mg	500 mg	1 g
Recommended adjusting weight F1 (not supplied)	3 kg	5 kg	5 kg + 2 kg	10 kg
Adjustment points	1 kg 2 kg 3 kg	1 kg 2 kg 5 kg	2 kg 4 kg 5 kg 7 kg 8 kg	2 kg 5 kg 10 kg
Stabilization time (typical)	3 sec.			
Humidity of air	max. 80% relative (not condensing)			
Permitted environmental temperature	+10 °C ... + 40 °C			
Warm-up time	2 h			
Housing (B x D x H) [mm]	228 x 228 x 70			
Vibration filter	yes			
Weighing plate stainless steel [mm]	228 x 228	228 x 228	315 x 305	228 x 228
Balance Input voltage	12 V, 300 mA			
Power supply unit Input voltage	100 V – 240V			
Units	see menu			
Net weight (kg)	5,5	5,5	7,5	5,5
Interface	RS232			
Rechargeable battery pack KB-A01N	7,2 V / 2000mAh			

KERN	DS 16K0.1	DS 20K0.1	DS 30K0.1	DS 36K0.2
Readability (d)	0,1 g	0,1 g	0,1 g	0,2 g
Weighing range (max)	16.000 g	20.000 g	30.000 g	36.000 g
Taring range (subtractive)	16.000 g	20.000 g	30.000 g	36.000 g
Reproducibility	0,1 g	0,1 g	0,2 g	0,2 g
Linearity	±0,3 g	±0,3 g	± 0,5 g	±0,6 g
Smallest part weight for piece counting under laboratory conditions	10 mg	10 mg	10 mg	100 mg
Smallest part weight for piece counting under normal conditions	100 mg	100 mg	100 mg	1 g
Recommended adjusting weight F1 (not supplied)	10 kg + 5 kg	20 kg	20 kg + 10 kg	20 kg + 10 kg
Adjustment points	5 kg 10 kg 15 kg 16 kg	5 kg 10 kg 15 kg 20 kg	10 kg 15 kg 20 kg 30 kg	10 kg 15 kg 20 kg 30 kg 36 kg
Stabilization time (typical)	3 sec.			
Humidity of air	max. 80% relative (not condensing)			
Permitted environmental temperature	+10 °C ... + 40 °C			
Warm-up time	2 h			
Housing (B x D x H) [mm]	315 x 305 x 70			
Vibration filter	yes			
Weighing plate stainless steel [mm]	315 x 305			
Balance Input voltage	12 V, 300 mA			
Power supply unit Input voltage	100 V – 240V			
Units	see menu			
Net weight (kg)	7,5			
Interface	RS232			
Rechargeable battery pack KB-A01N	7,2 V / 2000mAh			

KERN	DS 30K0.1L	DS 36K0.2L	DS 60K0.2
Readability (d)	0,1 g	0,2 g	0,2 g
Weighing range (max)	30.000 g	36.000 g	60.000 g
Taring range (subtractive)	30.000 g	36.000 g	60.000 g
Reproducibility	0,2 g	0,2 g	0,4 g
Linearity	±0,5 g	±0,6 g	± 1,0 g
Smallest part weight for piece counting under laboratory conditions	100 mg	200 mg	200 mg
Smallest part weight for piece counting under normal conditions	1 g	2 g	2 g
Recommended adjusting weight F1 (not supplied)	20 kg + 10 kg	20 kg + 10 kg	60 kg
Adjustment points	10 kg 15 kg 20 kg 30 kg	10 kg 15 kg 20 kg 30 kg 36 kg	20 kg 30 kg 50 kg 60 kg
Stabilization time (typical)	3 sec.		
Humidity of air	max. 80% relative (not condensing)		
Permitted environmental temperature	+10 °C ... + 40 °C		
Warm-up time	2 h		
Housing (B x D x H) [mm]	450 x 350 x 115		
Vibration filter	yes		
Weighing plate stainless steel [mm]	450 x 350		
Balance Input voltage	12 V, 300 mA		
Power supply unit Input voltage	100 V – 240V		
Units	see menu		
Net weight (kg)	9,5		
Interface	RS232		
Rechargeable battery pack KB-A01N	7,2 V / 2000mAh		

KERN	DS 65K0.5	DS 65K1M	DS 100K0.5	DS 150K1
Readability (d)	0,5 g	1 g	0,5 g	1 g
Weighing range (max)	65.000 g	65.000 g	100.000 g	150.000 g
Taring range (subtractive)	65.000 g	65.000 g	100.000 g	150.000 g
Verification value (e)	-	10 g	-	-
Minimum load (Min)	-	50 g	-	-
Accuracy class	-	II	-	-
Reproducibility	0,5 g	1 g	0,5 g	1 g
Linearity	±1,5 g	±2 g	±1,5 g	±3 g
Smallest part weight for piece counting under laboratory conditions	500 mg	500 mg	500 mg	1 g
Smallest part weight for piece counting under normal conditions	5 g	5 g	5 g	10 g
Recommended adjusting weight F1 (not supplied)	50 kg	50 kg	100 kg	3 x 50 kg
Adjustment points	20 kg 30 kg 50 kg 60 kg	20 kg 30 kg 50 kg 60 kg	20 kg 50 kg 100 kg	50 kg 100 kg 150 kg
Stabilization time (typical)	3 sec.			
Humidity of air	max. 80% relative (not condensing)			
Permitted environmental temperature	+10 °C ... + 40 °C			
Warm-up time	2 h			
Housing (B x D x H) [mm]	450 x 350 x 115			
Vibration filter	yes			
Weighing plate stainless steel [mm]	450 x 350			
Balance Input voltage	12 V, 300 mA			
Power supply unit Input voltage	100 V – 240V			
Units	see menu			
Net weight (kg)	9,5			
Interface	RS232			
Rechargeable battery pack KB-A01N	7,2 V / 2000mAh			

2.5 KERN FKB

KERN	FKB 6K0.02	FKB 8K0.05	FKB 16K0.05	FKB 16K0.1
Readability (d)	0,02 g	0,05 g	0,05 g	0,1 g
Weighing range (max)	6.000 g	8.000 g	16.000 g	16.000 g
Taring range (subtractive)	6.000 g	8.000 g	16.000 g	16.000 g
Reproducibility	0,04 g	0,05 g	0,1 g	0,1g
Linearity	±0,1 g	±0,15 g	±0,25 g	± 0,3 g
Smallest part weight for piece counting under laboratory conditions	20 mg	50 mg	50 mg	100 mg
Smallest part weight for piece counting under normal conditions	200 mg	500 mg	500 mg	1 g
Recommended adjusting weight F1 (not supplied)	5 kg	5 kg + 2 kg	10 kg + 5 kg	10 kg + 5 kg
Adjustment points	1 kg 3 kg 5 kg 6 kg	2 kg 4 kg 5 kg 7 kg 8 kg	5 kg 10 kg 15 kg 16 kg	5 kg 10 kg 15 kg 16 kg
Stabilization time (typical)	3 sec.			
Humidity of air	max. 80% relative (not condensing)			
Permitted environmental temperature	+10 °C ... + 40 °C			
Warm-up time	2 h			
Housing (B x D x H) [mm]	350 x 390 x 120			
Vibration filter	yes			
Weighing plate stainless steel [mm]	340 x 240			
Balance Input voltage	12 V, 300 mA			
Power supply unit Input voltage	100 V – 240V			
Units	see menu			
Net weight (kg)	6,5			
Interface	RS232			
Battery operation	6 x 1,5 V; Size C			

KERN	FKB 36K0.1	FKB 36K0.2	FKB 65K0.2	FKB 65K0.5
Readability (d)	0,1 g	0,2 g	0,2 g	0,5 g
Weighing range (max)	36.000 g	36.000 g	65.000 g	65.000 g
Taring range (subtractive)	36.000 g	36.000 g	65.000 g	65.000 g
Reproducibility	0,2 g	0,2 g	0,4 g	0,5 g
Linearity	±0,5 g	±0,6 g	±1,0 g	± 1,5 g
Smallest part weight for piece counting under laboratory conditions	100 mg	200 mg	200 mg	500 mg
Smallest part weight for piece counting under normal conditions	1 g	2 g	2 g	5 g
Recommended adjusting weight F1 (not supplied)	20 kg + 10 kg	20 kg + 10 kg	50kg + 10 kg	50kg
Adjustment points	10 kg 15 kg 30 kg 36 kg	10 kg 20 kg 30 kg 36 kg	15 kg 30 kg 50 kg 60 kg	20 kg 30 kg 50 kg 60 kg
Stabilization time (typical)	3 sec.			
Humidity of air	max. 80% relative (not condensing)			
Permitted environmental temperature	+10 °C ... + 40 °C			
Warm-up time	4 h	2 h	4 h	2 h
Housing (B x D x H) [mm]	350 x 390 x 120			
Vibration filter	yes			
Weighing plate stainless steel [mm]	340 x 240			
Balance Input voltage	12 V, 300 mA			
Power supply unit Input voltage	100 V – 240V			
Units	see menu			
Net weight (kg)	6,5			
Interface	RS232			
Battery operation	6 x 1,5 V; Size C			

KERN	FKB 8K0.1M	FKB 65K1M
Readability (d)	0,1 g	1 g
Weighing range (max)	8.000 g	65.000 g
Taring range (subtractive)	8.000 g	65.000 g
Verification value (e)	1,0 g	10 g
Minimum load (Min)	5,0 g	50 g
Accuracy class	II	II
Reproducibility	0,1 g	1 g
Linearity	± 0,3 g	± 3 g
Smallest part weight for piece counting under laboratory conditions	100 mg	1 g
Smallest part weight for piece counting under normal conditions	1 g	10 g
Recommended adjusting weight F1 (not supplied)	5 kg + 2 kg	50 kg
Adjustment points	2 kg 5 kg 7 kg 8 kg	20 kg 30 kg 50 kg 60 kg
Stabilization time (typical)	3 sec.	
Humidity of air	max. 80% relative (not condensing)	
Permitted environmental temperature	+10 °C ... + 40 °C	
Warm-up time	2 h	
Housing (B x D x H) [mm]	350 x 390 x 120	
Vibration filter	yes	
Weighing plate stainless steel [mm]	340 x 240	
Balance Input voltage	12 V, 300 mA	
Power supply unit Input voltage	100 V – 240V	
Units	see menu	
Net weight (kg)	6,5	
Interface	RS232	
Battery operation	6 x 1,5 V; Size C	

3 Fundamental information (general)

It is essential to read through and observe the complete operating instructions before installing and commissioning.

3.1 Intended use

The balance you have acquired serves to determine the weighing value of the material to be weighed. It is intended to be used as a “non-automatic” balance, i.e. the material to be weighed is manually and carefully placed in the centre of the weighing plate. The weighing value can be read off after a stable weighing value has been obtained.

3.2 Inappropriate use

Do not use the balance for dynamic weighing. In the event that small quantities are removed or added to the material to be weighed, incorrect weighing results can be displayed due to the “stability compensation” in the balance. (Example: Slowly draining fluids from a container on the balance.)

Do not leave a permanent load on the weighing plate. This can damage the measuring equipment.

Be sure to avoid impact shock and overloading the balance in excess of the prescribed maximum load rating (max.), minus any possible tare weight that is already present. This could cause damage to the balance.

Never operate the balance in hazardous locations. The series design is not explosion-proof.

Structural alterations may not be made to the balance. This can lead to incorrect weighing results, faults concerning safety regulations as well as to destruction of the balance.

The balance may only be used in compliance with the described guidelines. Varying areas of application/planned use must be approved by KERN in writing.

Guarantee

The guarantee is not valid following

- non-observation of our guidelines in the operating instructions
- use outside the described applications
- alteration to or opening of the device
- mechanical damage and damage caused by media, liquids
- natural wear and tear
- inappropriate erection or electric installation
- overloading of the measuring equipment

3.3 Monitoring the test substances

The metrology features of the balance and any possible available adjusting weight must be checked at regular intervals within the scope of quality assurance. For this purpose, the answerable user must define a suitable interval as well as the nature and scope of this check. Information is available on KERN's home page (www.kern-sohn.com) with regard to the monitoring of balance test substances and the test weights required for this. Test weights and balances can be adjusted quickly and at a reasonable price in KERN's accredited DKD calibration laboratory (return to national normal).

4 Fundamental safety information

4.1 Observe the information in the operating instructions



Carefully read this operation manual before setup and commissioning, even if you are already familiar with KERN balances.

Versions in other languages are non-binding translations. The only binding version is the original document in German.

4.2 Staff training

The device may only be operated and looked after by trained members of staff.

5 Transport and storage

5.1 Acceptance check

Please check the packaging immediately upon delivery and the device during unpacking for any visible signs of external damage.

In the case of visible damages please obtain a signature from the bearer to serve as confirmation of damage. Do not make alterations to the goods and packaging, do not remove any consignment parts. Report the damage to the parcel service immediately in writing (within 24 hours).

5.2 Packaging

Please retain all parts of the original packaging in case it should be necessary to return items at any time.

Only the original packaging should be used for return consignments.

Before despatch, disconnect all attached cables and loose/movable parts, remove weighing plate.

Apply any intended transport security devices. Secure all parts, e.g. glass windshield, weighing plate, power unit etc., to prevent slipping and damage.

6 Unpacking, installation and commissioning

6.1 Place of installation, place of use

The balance is constructed in such a way that reliable weighing results can be achieved under normal application conditions.

By selecting the correct location for your balance, you will be able to work quickly and precisely.

Therefore please observe the following at the place of installation:

- Place the balance on a firm, level surface;
- Avoid extreme heat as well as temperature fluctuation caused by installing next to a radiator or in the direct sunlight;
- Protect the balance against direct draughts due to open windows and doors;
- Avoid jarring during weighing;
- Protect the balance against high humidity, vapours and dust;
- Do not expose the device to extreme dampness for longer periods of time. Inadmissible bedewing (condensation of air moisture on the device) can occur if a cold device is taken into a significantly warmer environment. In this case, please acclimatise the device for approx. 2 hours at room temperature after it has been disconnected from the mains.
- Avoid static charging of the material to be weighed, weighing container and windshield.

Major display deviations (incorrect weighing results) are possible if electromagnetic fields occur as well as due to static charging and instable power supply. It is then necessary to change the location.

6.2 Unpacking

Carefully remove the balance from its packaging, remove the plastic wrapping and position the balance in its intended working location.

6.2.1 Installation

Install the balance in such a fashion that the weighing plate is absolutely horizontally.

6.3 Mains supply

Electric power supply is by means of the external mains supply circuit. The printed voltage level must comply with the local voltage.

Only use original KERN mains supply circuits. The use of other makes is subject to approval by Kern.

6.4 Battery operation FKB



- ⇒ To insert the batteries (6 x 1.5 V) remove the battery compartment cover. Remove it with the help of a coin.
- ⇒ In the each battery tube insert three batteries in the same polarity sense.
- ⇒ Screw down again the battery cover.

To save the battery, the background illumination can be switched off (see chap. 7.3). Moreover the AUTO-OFF function can be activated (see chap. 7.2.10). If the battery voltage drops below a critical value for operational safety, this will be indicated in the display with the "BATT LOW" information.

6.5 Connecting peripheral equipment

The balance must be disconnected from the mains before connecting or disconnecting additional equipment (printer, PC) to or from the data interface.

Only use KERN accessories and peripheral equipment with your balance. These have been ideally coordinated to your balance.

6.6 Initial start-up

A warm-up time of 2 hours stabilises the measured values after switching on.

The accuracy of the balance depends on the local acceleration of the fall. Please be sure to observe the information in the chapter on adjusting.

6.7 Adjustment

As the acceleration value due to gravity is not the same at every location on earth, each balance must be coordinated – in compliance with the underlying physical weighing principle - to the existing acceleration due to gravity at its place of location (only if the balance has not already been adjusted to the location in the factory). This adjustment process must be carried out during the initial start-up, after change in location and variation of surrounding temperature. It is also recommendable to adjust the balance periodically during weighing operation in order to obtain exact measured values.

6.8 Adjusting (go to 7.2.6)

Using a precision weight, the accuracy of the balance can be checked at any time and adjusted.

Warning:

With verified balances, this precision adjustment is not possible.

Adjustment procedure:

Check that the surrounding conditions are stable.

A short warm-up time of about 15 minutes is recommended for stabilisation.

6.8.1 Adjusting for verification (KERN 573; FKB-M; KB-NM; DS-M)

General Information:

Prior to the procedure of verification the balance has to be adjusted.

Remark: The adjusting is only possible when not being blocked by the adjusting switch. The switch for this step is located at the bottom of the housing between the two turning feet.

At the model FKB the cover plate from the housing bottom must be removed.

Switch to the right	Adjusting function is released.
	This setting has to be selected before starting the adjusting.
	Executing the adjusting according to chapter 7.2
	After the adjusting has been completed successfully it is necessary to turn the adjusting switch to the left for blocking.
Switch to the left	Adjusting function is blocked.
	After the adjusting has been completed successfully the adjusting has to be blocked by switching to the left.
	The balance is now prepared for the procedure of verification.
	After the verification the adjusting switch has to be secured by a verification mark against access.

6.9 Verification

General introduction:

According to EU directive 2014/31/EU balances must be verified if they are used as follows (legally controlled area):

- a) For commercial transactions if the price of goods is determined by weighing.
- b) For the production of medicines in pharmacies as well as for analyses in the medical and pharmaceutical laboratory.
- c) For official purposes.
- d) For manufacturing final packages.

In cases of doubt, please contact your local trade in standard.

Verification instructions

An EU type approval exists for balances described in their technical data as verifiable. If a balance is used where obligation to verify exists as described above, it must be verified and re-verified in regular intervals.

Re-verification of a balance is carried out according to the respective national regulations.

The validity for verification of balances in Germany is e.g. 2 years.

The legal regulation of the country where the balance is used must be observed!



Verification of the balance is invalid without the "seal".

Balances with obligation to verify must be taken out of operation if:





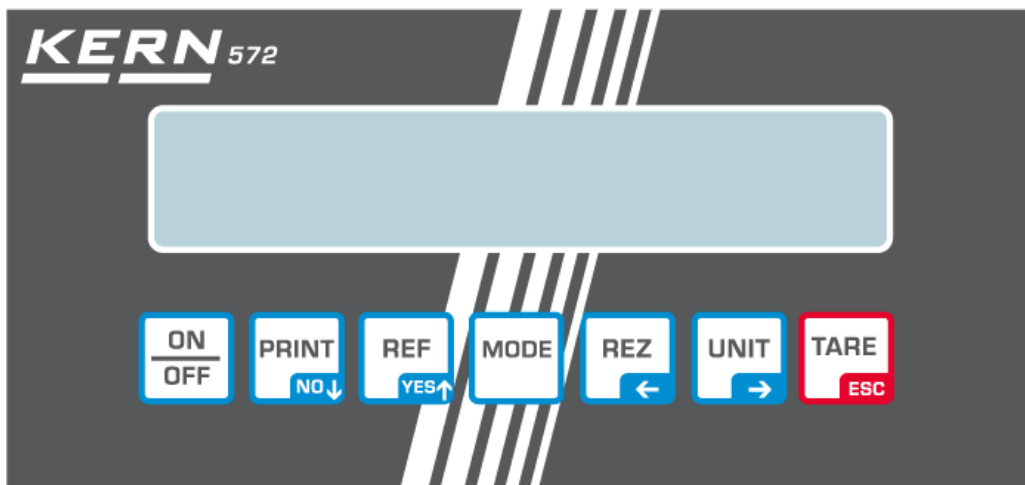

- **The weighing result of the balance is outside the error limit.** Therefore, in regular intervals load balance with known test weight (ca. 1/3 of the max. load) and compare with displayed value.
- **The re-verification deadline has been exceeded.**

7 Operation

7.1 Display control panel



Keyboard:

-  ON / OFF
-  Print weighing result
in MODE: No / descending
-  **in % and counting mode:**
Form reference
in MODE: Yes / ascending
-  MODE configuration
(see mode structure diagram page 2)
-  Formula weighing
in MODE: to left
Change g-pieces
-  Unit changeover
in MODE: to right
-  Tare
in MODE: back in weighing operation

Display-Symbol	Meaning
==OVERLOAD==	Overload: Weighing range has been exceeded
=====	Underload: Weighing range has been fallen short of
<<	In counting and % mode: part too light
□	Automatic tare active / In verification operation zero display
PTA	Preselect tare Tare pre-selection active
D	Difference in % during percentage weighing
Net	Net weight of the components during formula preparation
SUM	Gross weight of several components during formula preparation
→	Balance is in counting mode and currently displaying the weight value of the counting amount
III.	For multirange balance in verification operation indication of range
Wait > 299 s	Warm-up time if verifiable (switch-on drift monitoring)

7.2 Operation

7.2.1 WEIGHING with TARE

During weighing in a certain weight amount of a product is to be filled into a weighing container with-out the tare weight of the container being weighed. The weighing container is excluded from consideration by using TARE and thus only the measured value of the product is indicated. The maximum weighing range is reduced by the value of the tare weighing container – tare is therefore classed as being subtractive. Wait until the g or kg unit symbol appears on the display. The weighing result is now stable.

7.2.2 COUNT - Selection reference piece

In order to be able to count a larger quantity of parts it is necessary to determine the average weight of each part using a small quantity (**reference piece number**).

The greater the reference piece number, the greater the counting accuracy.

In the case of small or very varied parts, a particularly high reference piece number must be selected.

COUNT

Commence by applying the number of parts of the determined reference piece number.

Using the automatic reference optimization (**OPT**) the counting accuracy is automatically increased when applying up to 100 items.

Now apply the quantity to be counted.

7.2.3 PERCENT %

When using **percentage weighing** it is possible to remove partial amounts from the weighing container. Instead of the manual withdrawal there can also, for example, the evaporated amount of moisture during a drying sequence be displayed as a percentage.

To begin with the percentage of the removed parts is displayed.

The remaining amount in the container is shown as a percentage by operating the REZ key.

7.2.4 FORMULA WEIGHING

The **formula weighing** function makes it possible to weigh in several components (K1, K2, ...,Kn) in succession and subsequently determine the total weight of the components.

Return to weighing mode by pressing the ESC key.

7.2.5 TOLERANCE WEIGHING

When using **tolerance weighing** the parts to be checked are compared with a target value and the divergence displayed as a plus or minus value when compared to the target value.

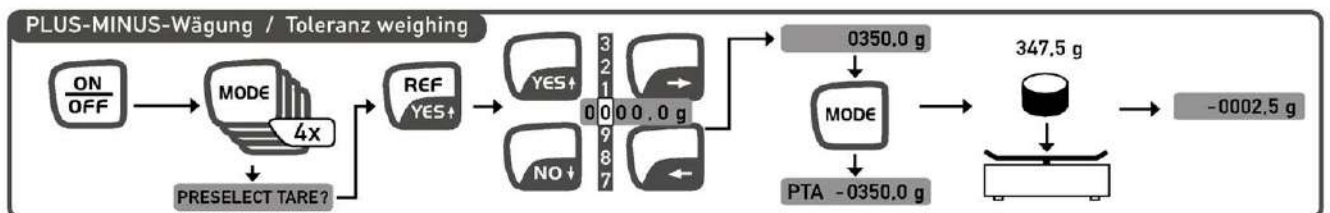
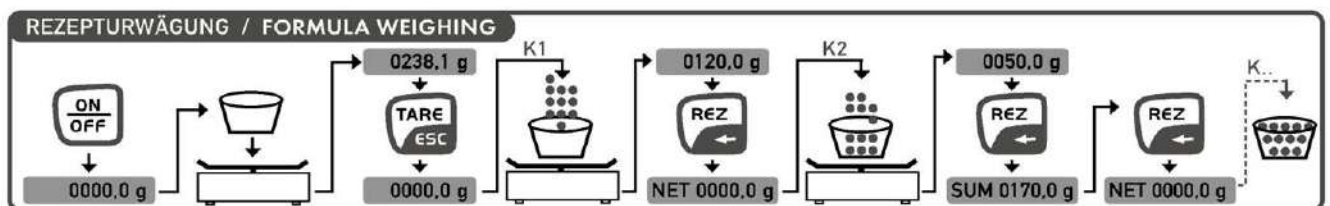
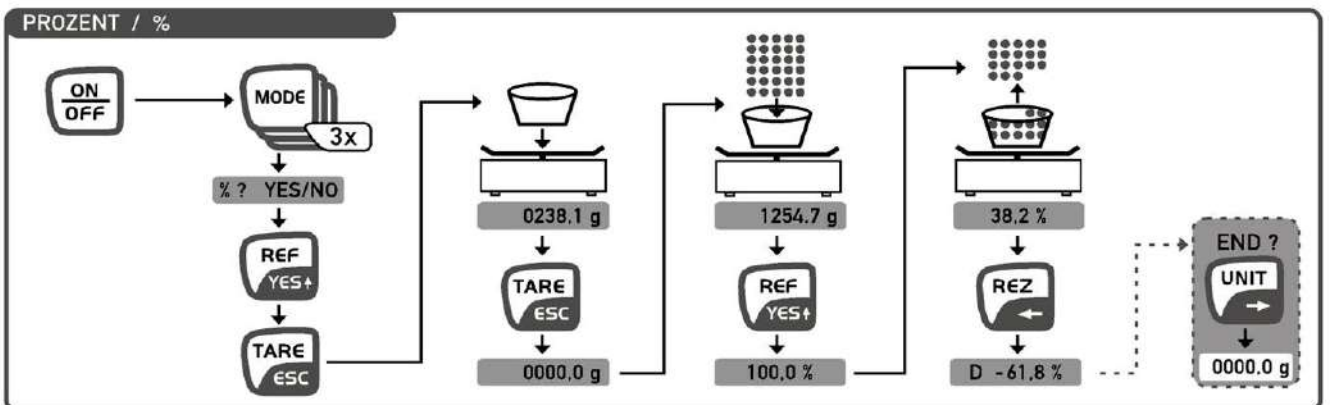
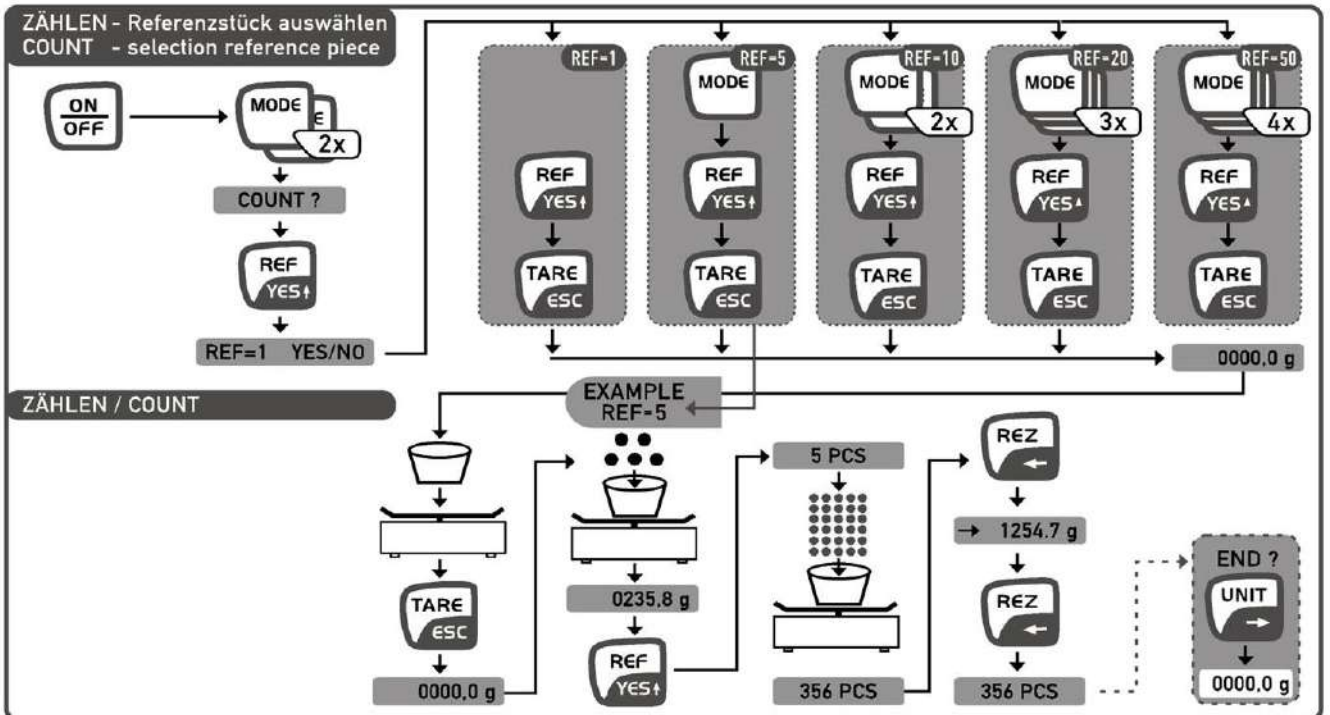
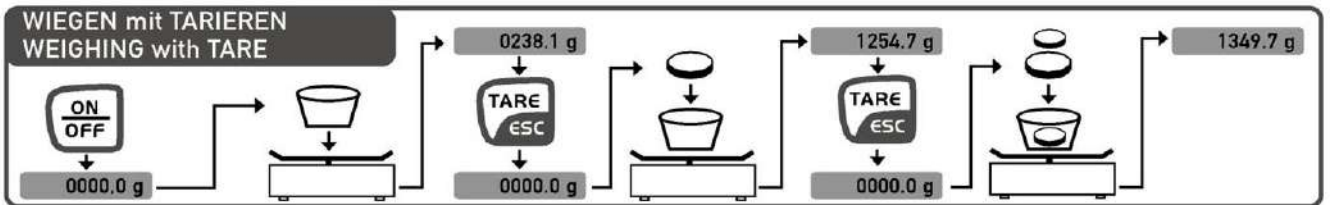

7.2.6 ADJUST

The balance must be **adjusted** at its place of installation before initial use and at regular intervals.

Please observe the warm-up time referred to in the chapter on "Commissioning".
It is essential to avoid jarring and disturbances during the adjusting procedure.

7.2.7 PRESELECT TARE

The known tare value of a weighing container can be "deducted" by entering its weight as **preselect tare**.
In this way only the net weight of the goods to be weighed is displayed during subsequent weighings.
PTA will be seen on the display. Manual tare may not be carried out using the TARE key.

7.2.8 AUTO TARE active

AUTO TARE inactive

Auto tare activation serves to stabilize the zero point of the balance. Minor changes in weight in the zero point range are tared automatically, i.e. the displayed figure remains at zero.

7.2.9 FILTER / SPEED

The balance can be adapted in stages to its location from 1 – 5.

Stage 1 = good installation conditions, fast **display / low filter effect** (e.g. proportioning)

Stage 5 = poor installation conditions, slow **display / high filter effect** (restless environment) e.g. proportion weighing requires a greater display speed and this can be adjusted by selecting "Fast" in the MODE program.

7.2.10 AUTO OFF active

AUTO OFF inactive

The auto-off function inactivates the balance after approx. 60 seconds if it is not in use.

7.2.11 VARIABLE FACTOR

The weighing value in grams is automatically multiplied by the set variable factor and the result (including the unit *) shown on the display. Example:

A sheet of paper sized 10 x 10cm weighs 0,6 g. In order to determine the weight g/m², the factor has to be at 100.
The display value is 0,6g x 100 = 60,0*, thus 60,0 g/m².

7.2.12 PRESELECT UNIT

UNIT - select

All selected units checked YES in Preselect Units are offered on the UNIT key in weighing mode for unit changeover.
Recommendation: Only preselect the units that are actually required.

Each time the UNIT key is pressed, the next preselected unit (using Preselect Units) is selected.

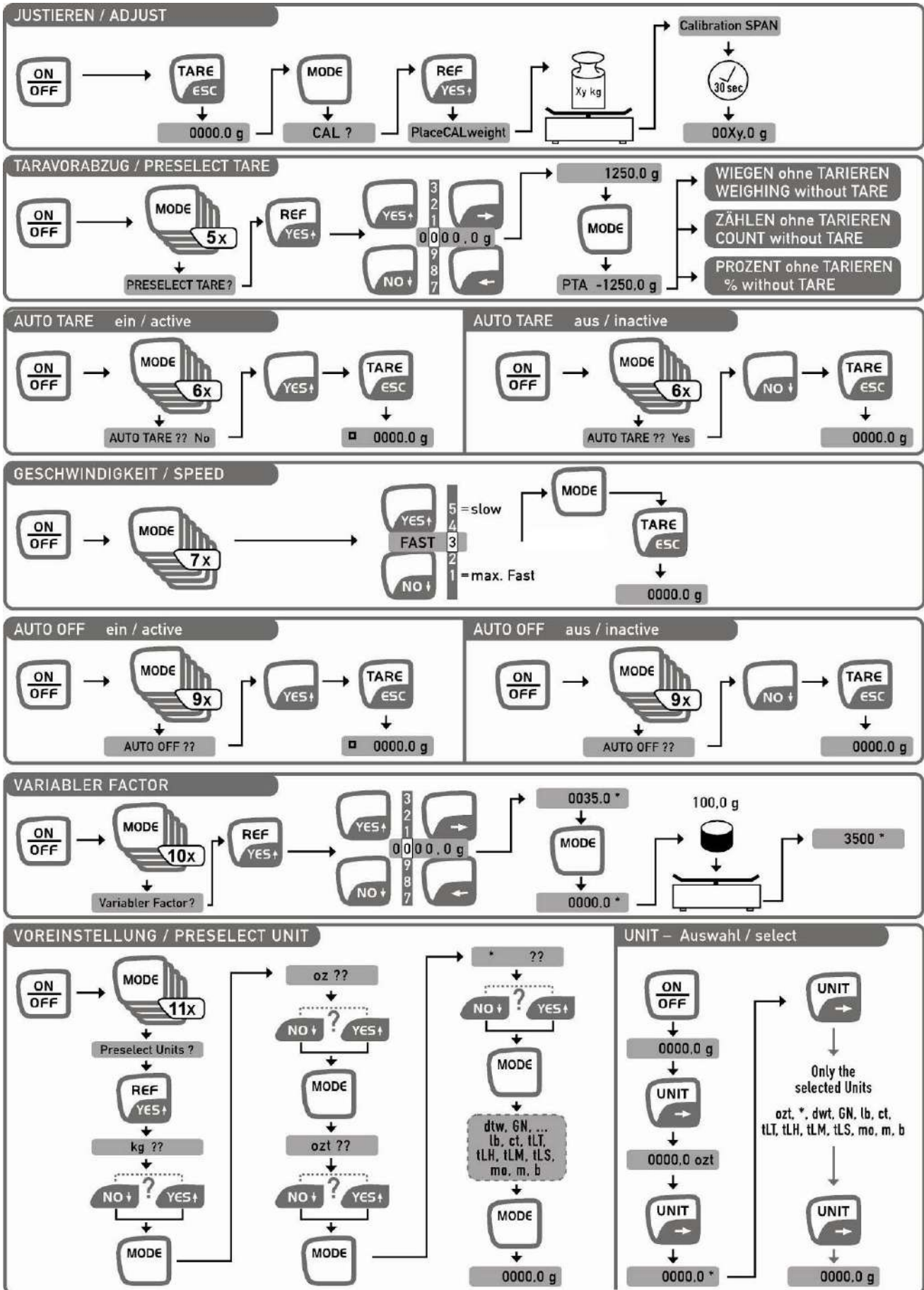

7.2.13 Animal weighing:

- Activate via mode/animal weigh. Y/N (4xMode)
- Put container without measured object on the weighing surface and tare
- Place the measured object (animal) in the container and start with REF/YES key
- The value averaging in shown in the display with AVG as well as by extinguishing of the character blocks and the subsequently fixed display value.
- Printing and deleting of the average value can be triggered by the PRINT key
- Simple deleting is possible by pressing the TARE key.
-

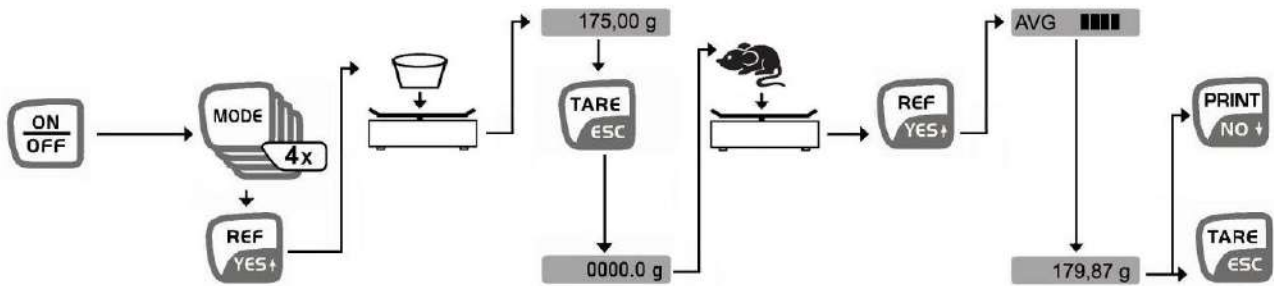

7.2.14 Swap:

- Strong filtering

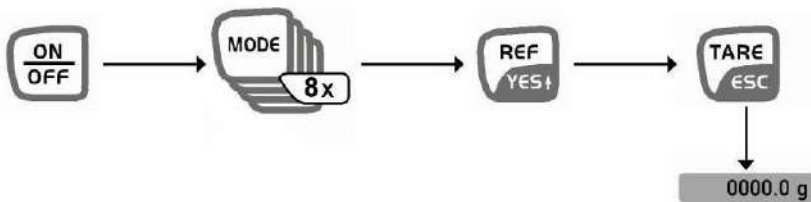

7.3 Display background illumination

After having switched on your balance and the zero display, press the „MODE“ button to select the menu point „Backlight“. Acknowledge by pressing the „YES“ button in order to switch on the permanent background illumination. By pressing the „NO“ button, the background illumination is switched off.

If the background illumination shall be switched off time-controlled (to save the battery), press the „MODE“ button to select the menu point „Backlight auto“ and confirm by pressing the „YES“ button. The background illumination will be switched off automatically 10 sec after having reached a stable weighing value.

7.4 Interface RS 232 C

Technical Data

- 8-bit ASCII Code
- 1 start bit, 8 data bits, 1 stop bits, no parity bit
- Baud rate adjustable to 2400, 4800 and 9600 baud (default), 19200 baud
- Sup-D- 9 pol. is necessary .
- When working with an interface correct operation is secured only if the corresponding KERN-interface-cable (max. 2m) is used.

Description of the jack

Sup-D- 9 pol.

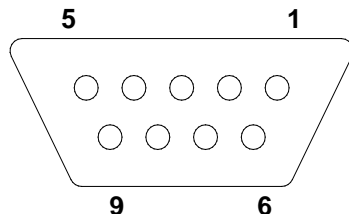

Pin 2: Transmit data

Pin 3: Receive data

Pin 5: Signal ground

Baudrate

The Baud rate for the data transfer is adjusted with the MODE-key. The following example demonstrates how to set the Baud rate 4800.

Select Baud rate	Display
1. Press MODE-key repeatedly until "PRINTER" is displayed.	PRINTER?
2. Press YES-key.	2400 Baud
3. Press MODE-key repeatedly until the desired Baud rate appears (for instance 4800 Baud).	4800 Baud
4. Press YES-key to select 4800 Baud. The tick-mark (X) confirms the new setting.	4800 Baud X
5. Press MODE-key repeatedly until the balance displays in grams again, or press tare key.	0.0 g

7.5 RS 232 C Data output via interface RS 232 C

RS 232 C Data output via interface RS 232 C

General information

As a condition for the data transfer between the balance and a peripheral device (for instance printer, PC ...) both device have to be set on the same interface parameter (for instance baud rate, parity ...).

There are 5 methods for the data output via RS 232 C

Data output via PRINT-Key

The printing process can be released by the PRINT-key. In this case the settings AUTO-PRINT and AUTPRINT PC should be deselected.

AUTOPRINT (Data output, after having loaded the balance)

The setting AUTOPRINT is in the PRINTER-routine, and there it can be selected or deselected. When AUTOPRINT is active the actual weighing value will be sent via the RS 232 interface when the balance has been unloaded and then loaded after having achieved the stability.

AUTOPRINT PC (Continuous data output)

The setting AUTPRINT PC is in the PRINTER-routine, and there it can be selected or deselected. When AUTOPRINT PC is active the actual weighing values will be sent continuously via the RS 232 interface.

Data output by transfer of remote controls

The following functions can be released by the remote controls that will be transferred as ASCII signs to the balance.

t Tare.

w a weighing value (or unstable) is sent via RS 232 interface.

s a stable weighing value is sent via RS 232 interface.

If the balance receives the command w or s, it acts without printing delay.

Output on bar code printer

The data transfer mode has to be set on „Barcode“.

As bar code printer a Zebra printer model LP2824 is provided.

Take into account that the output format of the balance is fixedly defined and cannot be changed.

The printer format is stored in the printer, i.e. in case of a failure the printer cannot be changed with a new one from factory, previously it is necessary that KERN installs the respective software.

The Zebra printer and the balance must be connected to the delivered interface cable when they are switched off.

After switching-on both appliances, and after reaching the status ready-for-operation, a label will be printed out when pressing the  key.

7.5.1 Description of the data transfer

Structure of each data transfer:

Bit-Nr.	1	2	3	4	5	6	7	8	9	10	11	12	13	14	15	16	17	18
	B*	N	N	N	B	B	B	B	B	0	.	0	0	E	E	E	CR	LF

N = Numerator

B*: = Blank or in the range of zero point.

B, 0, ;, g: = Blank or weighing value with unit, depending on the load on the weighing plate.

E = Unit

CR: = Carriage Return

LF: = Line Feed

7.5.2 Numerator

The Numerator is found under the menu point "Printer" and can be activated and deactivated. When editing data with the use of the print option, the range of the numerator will increase by one place.

7.6 Printer

With the serial data output RS 232 a printer can be connected.

The printout shows the weight in grams. When the counting mode is selected the number of pieces or the weight is printed. When the percent mode is selected, the percentage or the weight will be printed. Press The PRINT-key to print weighing results. Select the enumerator to number the weighing continuously. Turn off the balance or use the CLEAR function to Reset the enumerator to (000).

7.7 Underfloor weighing

Objects which, because of their size or shape, cannot be put on the scale, can be weighed by means of underfloor weighing.

Proceed as follows:

- Switch off the balance.
- Turn the balance over, without loading the balance plate.
- Open the cover plate on the base of the balance.
- Hang on the hook for underfloor weighing .
- Place the balance over an opening.
- Hang the item to be weighed on the hook and carry out weighing.

! CAUTION !

**Take care that the hooks used for the underfloor weighing are stable enough to hold the goods which you wish to weigh (risk of breakage).
Always make sure that there are no living beings or materials below the load that could be injured or damaged.**

! NOTE !

After completing the underfloor weighing, the opening in the floor of the balance must be closed again (dust protection).

8 Maintenance, upkeep, disposal

8.1 Cleaning

Please disconnect the device from the operating voltage before cleaning.

Only use a cloth dampened with mild suds and not aggressive cleaning agents (solvents or similar). Please ensure that fluids are not able to get into the device and rub off using a clean, soft cloth.

Loose sample residue/powder can be removed carefully using a brush or hand vacuum cleaner.

Remove any spilt material to be weighed immediately.

8.2 Maintenance, upkeep

The device may only be opened by trained service engineers authorised by KERN.

Disconnect from the mains supply before opening.

8.3 Disposal

The operating company shall dispose of the packaging and the device in compliance with the valid national or regional law of the operating location.

9 Troubleshooting

The balance should be switched off for a short time following an interruption in the programme sequence and disconnected from the mains supply. It is then necessary to repeat the weighing process from the beginning.

Help:

Interruption

Weight display is not illuminated.

Possible cause

- The balance is not switched on.
- The mains supply connection has been interrupted (mains cable not plugged in/faulty).
- Power supply interrupted. .
- Draught/air movement

The weight display changes continually

- Table/floor vibrations
- The weighing plate is in contact with foreign matter.
- Electromagnetic fields / static charging (choose different location/switch off interfering device if possible)

The weighing result is obviously incorrect

- The balance display is not set to zero
- Adjustment is no longer correct.
- Great fluctuations in temperature.
- Electromagnetic fields / static charging (choose different location/switch off interfering device if possible)

Switch the balance off if other error messages should appear and then switch on again. Contact the manufacturer if the error message does not disappear.

10 Declaration of conformity

To view the current EC/EU Declaration of Conformity go to:

www.kern-sohn.com/ce

i The scope of delivery for verified weighing balances (= conformity-rated weighing balances) includes a Declaration of Conformity.