

Product Catalogue



Your Total Temperature Solution

Designed for today's busy restaurant kitchens, food processing facilities and storage areas, Comark's range of thermometers and related temperature and humidity instruments lead the industry. Whether it's a waterproof C22 thermometer, PDT300 pocket digital thermometer, or a FoodPro Plus infrared with probe, Comark has a solution to fit your budget.

Prevent the outbreak and spread of foodborne illness. Our range of monitoring and recording instruments – N5001HACCP Auditor, Diligence and EVt logger ranges, and the RF500 wireless system – offer accurate and tamper-proof recording of key parameters to augment your HACCP and food safety programme.

Designed especially for the food industry Comark instruments meet a number of key international standards:

- IP ratings tell the user immediately how effectively the electrical instrument case protects against the ingress of dust and water.
- The CE mark certifies that the product meets European health and safety regulations.
- All of our key products are NSF certified so you can trust that they meet their published accuracy and specifications.

Selected Comark thermometers, probes and data loggers have BioCote® silver technology incorporated into instrument cases and probe handles at the time of manufacture. The antimicrobial finish inhibits the growth of foodborne bacteria, therefore reducing the risk of cross-contamination within the environment. BioCote® has been officially recognised for its benefits within the food industry with HACCP International Certification. HACCP International Certification supports organisations that demonstrate food safety excellence in non-food products that are designed for, or are commonly used in, the food industry. BioCote® is the only antimicrobial solution to be awarded HACCP International Certification.

With our wide range of products, a knowledgeable staff and commitment to your satisfaction, you can count on Comark for answers to all your temperature measurement needs.

C22 Dual Sensor Thermometer With locking probe connector

- Clock display
- Waterproof
- Long battery life up to 5 years
- Wide variety of probes
- T-Type thermocouple and thermistor



Quick – Reliable – Accurate



FPP FoodPro Plus
Infrared thermometer with flip down
penetration probe



UTL80
Refrigerated drawer stick-on
thermometer

Double stick tape for securing to
a refrigerated drawer



300B
Ruggedized and water resistant

New thin tip and field calibratable with
an accuracy of $\pm 1^\circ\text{C}$ (2°F)

PDQ400
Waterproof, field calibratable with a
thin 1.5mm tip



Diligence WiFi
Data Loggers
Wireless temperature
and humidity monitoring
with alarms



Diligence WiFi

HACCP Auditing

N5001USB HACCP Auditor

Maintain all your Food Safety and HACCP records in one convenient database. Eliminate clipboards and manual record-keeping.

The N5001USB is a unique data management tool for all aspects of a food service or food processing operation. You can record temperatures at receiving, storage, prep, hot holding or cold holding plus incorporate the many other checklists you've been filling out by hand. All this with a simple series of screens that are unique to your operation. Design them yourself with our free-form software.

- Corrective Action selections ensure that failures are corrected immediately
- Filter data to quickly find or analyse non-conformances
- Auditor data is in real time and is tamper-proof
- Export to Excel or Access for reporting to upper management
- Simulation sequence allows you to fine-tune any changes before you finalise a program
- Instruction screens can be included to aid in employee training
- Programming offered via special quotation
- T-Type thermocouple probes with Lumberg connector
- Range: -200° to 400°C (-328° to 752°F)
- Accuracy $\pm 0.2\%$ of reading
 $\pm 0.2^\circ\text{C}$ (full range)
- Large, backlit graphic display
- BioCote® antimicrobial protection
- Waterproof and rugged IP67 case
- Battery: 2 x AA Alkaline

Typical screens

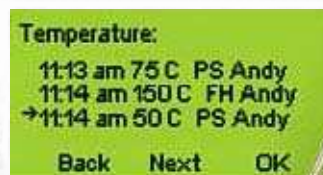

N5001USB Auditor Product Line

N5001USB	Auditor
CRS/6	Protective Rubber Boot
SWAUDITOR	Software
MC28	Hard Carrying Case
PT19L	Penetration Probe with 1.5mm tip
PT24L/C	Penetration Probe with 3.3mm tip



C22

Dual Sensor – T-Type thermocouple or thermistor with secure Lumberg connector

For complete assurance that the unit and probe “system” accuracy is better than 0.5°C, the C22 with a Comark Lumberg connector is your best answer. The C22 comes in a robust waterproof and rugged case and also includes the Clock, Countdown Timer, Data Hold and Auto Switch Off features.

- System Accuracy (Type-T Thermocouple): $\pm 0.5^{\circ}\text{C}$ (0.9°F)*
- System Accuracy (PST Thermistor): $\pm 0.3^{\circ}\text{C}$ (0.6°F)*
- Range: -200° to 400°C (-328° to 752°F)
- IP65/IP67

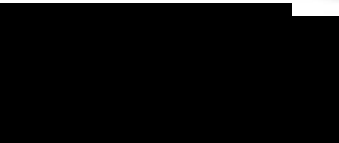

PX22L
Food penetration probe (3.3mm)

Temperature range: -40° to 150°C (-40° to 302°F)



PT24L/C
Food penetration probe (3.3mm)

Temperature range: -100° to 250°C (-148° to 482°F)

N9094

Triple sensor – T-Type, thermistor and K-Type thermocouple. Extra tough waterproof case for food processing environments

- Waterproof and dustproof to IP68 standard
- Range: -200° to 400°C (-328° to 752°F)
- Accuracy at $+23^{\circ}\text{C}$ (73°F): $\pm 0.5^{\circ}\text{C}$ ($\pm 0.9^{\circ}\text{F}$)*
- Clock, countdown timer and data hold
- 10 year battery life
- 2 year warranty
- Optional CRS/6 protective rubber boot
- Probes must be purchased separately

N9094 EHO Kit includes:

- N9094
- ST23L Surface Probe
- PT24L/C Penetration Probe
- AT22L Air Probe
- MC28 case
- PW70T wipes



PT19L
Penetration probe with reduced tip (1.5mm)

Temperature range: -100° to 250°C (-148° to 482°F)



PT23L
Needle probe with 100mm stem (1.6mm)

Temperature range: -100° to 250°C (-148° to 482°F)

Test Caps

Each cap simulates a specific temperature to check your thermistor thermometers. Each cap has a UKAS Certificate of Calibration.

Test Cap Order Code	Temperature Point
TX21L	-18°C
TX22L	-5°C
TX23L	0°C
TX24L	$+3^{\circ}\text{C}$
TX25L	$+63^{\circ}\text{C}$
TX26L	$+70^{\circ}\text{C}$



Economy Thermometers

P125 Pocketherm Thermistor

Pocketherm is fast and accurate. Set different probe angles for taking different temperatures. Audible alarm plus flashing LEDs instantly indicate critical HACCP zones.

Switches on when probe swings out!

NEAT:

Probe angles to fit the measurement

FAST:

Tapered probe for quicker response

COMPACT:

Fits easily in pockets or cases

LED indicators for quick recognition of HACCP temperature zones

Yellow:	Frozen	Below -18°C
Green:	Chilled	0°C to +5°C
Red:	Cooked	75°C and above

Specifications

Range:	-40°C to +125°C
Resolution:	0.1°
Accuracy:	±0.5°C from -20°C to +70°C
Battery:	9V
Auto Off:	After 1 hour



Catercheck 3 Thermometer

Simple single button operation with a permanently attached penetration probe.

- Simple single button on/off
- Auto switch off
- Battery life up to 5 years
- Temperature range -40°C to +125°C



C20 Thermistor Thermometer

Simple single button operation with a Lumberg connector that allows a range of thermistor type probes to be attached.

- Simple single button on/off
- Auto switch off
- Battery life up to 5 years
- Temperature range -40°C to +125°C



C12 HACCP Thermometer

Use where colour coding could reduce risks from cross-contamination. Supplied with five colour option labels.

- Simple single button operation
- Supplied with two probes, one penetration probe, one air probe
- Temperature range -40°C to +125°C
- Auto switch off
- Battery life up to 5 years

General Thermometers

K-Type Thermocouples

C28 Thermometer

K-Type Thermocouple with sub-miniature connector

Designed for heavy use in today's busy kitchens.

- Waterproof and rugged
- Built-in clock and countdown timer
- Up to 7,000 hour battery life
- Range: -200° to 600°C (-328° to 1112°F)
- Data hold and auto switch off
- BioCote® Antimicrobial Protection
- Settable alarms
- 2 Year Warranty
- Battery: 2 x AA Alkaline



C20WB
Probe caddy and wall bracket



C28 Legionella Kit

The C28 Legionella Kit is ideal for testing water towers and water systems in businesses, schools, dental practices, residential homes and other institutions where there could be high risk areas.

Thermometer range -200°C to +600°C.

C28 Legionella Kit includes:

- 1 x C28 Thermometer with sub-miniature connector
- 1 x UKAS Certificate at 0°, +70°C and +100°C (PRO1 Penetration Probe only)
- 1 x PRO1 Penetration Probe
- 1 x SK21M Surface Probe
- 1 x AK28M Air Probe
- 1 x PW70T Probe Wipes
- 1 x MC28 Carry Case

Part No. C28LKIT



Pocket Digital Thermometers

The sensor in all Comark pocket digital thermometers is positioned directly at the tip of the stem. So you are always ensured of a quick, accurate and reliable measurement. For the fastest readings, select a model with a thin 1.5mm stem.

300

Simple, compact styling and a great price for excellent value!

- Now field calibratable with a thin 1.5mm tip
- Range: -40° to 150°C (-40° to 300°F)
- Accuracy: $\pm 1^\circ\text{C}$ (2°F)
- Data hold
- Auto power off



New!

PDT300

Waterproof, field calibratable and a thin 1.5mm tip

The most popular thermometer for measuring thin foods.

- Range: -50° to 150°C (-58° to 300°F)
- Accuracy: $\pm 1^\circ\text{C}$ ($\pm 2^\circ\text{F}$)



KM14

Check dishwasher cycles

Check dishwasher rinse temperatures with this waterproof pocket digital thermometer.

- Range: -20° to 200°C (-4° to 400°F)
- Accuracy: $\pm 1^\circ\text{C}$ (2°F)
- Maximum temperature hold
- Field calibratable
- Stem diameter of 3.3mm





PDQ400

Waterproof, field calibratable and a thin 1.5mm tip

High accuracy pocket digital thermometer. Waterproof and field calibratable. Max temperature hold for use in commercial dishwashers.

- Range: -20° to 200°C (-4° to 400°F)
- Accuracy: ± 0.5°C (1°F)



DT400

Waterproof, field calibratable, max hold and dishwasher safe

A new extended range to cover all kitchen needs including fryer temperatures and dishwasher cycles. The 1.5mm tip means fast response and easy measurement of thin foods.

- Range: -20° to 200°C (-4° to 400°F)
- Accuracy: ± 0.5°C (1°F)



New!

300B

Ruggedized and water resistant

For added protection, the model 300 is packaged with the ARB300A protective rubber boot on a single slide card.



Pocket Dial Thermometers

Tough, durable and accurate

Comark's dial thermometers can't be beaten. All models feature stainless steel construction and a plastic watertight lens.

- Magnifying dial cover
- Recalibration nut
- 1 Year Limited Warranty

With Comark's patented calibration nut, you can easily calibrate your bi-metal thermometer in seconds with only a twist of your fingers. Once it is set, the nut stays tight and firmly in place.



T220/38A

Hot drink thermometer

Make steam table measurements with these large-face, easy-to-read thermometers. You can also use the T220A/38A for lattes.

- 20cm stem
- Sturdy clip attaches to cups or jugs
- Range: 0°F to 220°F
- Large face
- Accuracy: ± 1 division (2° div. °F)



T200LC

Latte thermometer

Check milk temperatures in lattes, espresso drinks and hot cocoa. The sturdy clip attaches securely to cups or pitchers.

- Special colour indication over frothing range
- Range: 0° to +100°C
- Accuracy: ± 1 division (2° div. °C)



Refrigerator and Freezer

New!



ERF1K
Economy fridge/freezer thermometer

This dual-scale economy thermometer hangs or stands and has easy-to-read bold numbers. Made of stainless steel.

- Range: -30° to 30°C (-20° to 86°F)
- Accuracy: ±1 division, 2° div. °C/°F



RFT2AK
Fridge/freezer thermometer

This thermometer hangs or stands with easy-to-read bold numbers. Blue and green zones indicate safe temperatures while red indicates possible spoilage.

- Range: -30° to 30°C
- Accuracy: ±1 division, 1° div. °C, 2° div. °F



UTL140
Indoor/outdoor stick-on thermometer

Includes both adhesive and magnetic mount.

- Range: -40° to 50°C, (-40° to 120°F)



UTL80
Refrigerated drawer stick-on thermometer

A modified RFT2A features double stick tape for securing inside a refrigerated drawer.

- Range: -30° to 25°C (-20° to 80°F)
- Accuracy: ±1°C

NSF

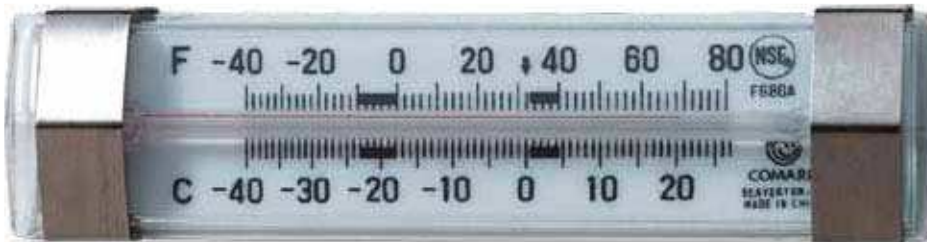

FG80AK
Fridge/freezer thermometer

This thermometer hangs or stands, has easy-to-read bold numbers, and a dual scale. Non-toxic, spirit filled.

- Range: -40° to 27°C (-40° to 80°F)
- Accuracy: ±1 division, 1° div. °C, 2° div. °F

NSF

EFG120C
Economy wall thermometer

This non-toxic spirit filled economy thermometer has protective end caps, bold numbers for easy reading, and can hang or be mounted.

- Range: -40° to 50°C, (-40° to 120°F)
- Accuracy: ±1 division, 1° div. °C, 2° div. °F

NSF

New!



New!



WT4
Wall thermometer

Spirit filled, 23cm length, plastic construction.

- Range: -30°C to +50°C (-20°F to +120°F)

Oven • Meat



MT200K
Meat thermometer

This dishwasher safe thermometer has an adjustable temperature indicator and dual range readings.

- Range: 60° to 85°C (120° to 200°F)
- Accuracy: ±1 division, 2° div



New!

DHH
Dial hot holding thermometer

Quickly see if hot food is staying hot! HACCP zone at 60°C.

- Range: 40° to 80°C (100° to 180°F)



DOT2AK
Oven thermometer

Easy-to-read bold numbers are displayed in coloured zones for quick reference. Hangs or stands.

- Range: 100° to 280°C (200° to 550°F)
- Accuracy: ±1 division, 10° div.



EMT2K
Economy meat thermometer

Stainless steel body, bold numbers for easy reading and dual scale measurement.

- Range: 60° to 87°C (140° to 190°F)
- Accuracy: ±1 division, 10° div, (°F)



New!

EOT1K
Economy oven thermometer

This economy stainless steel thermometer measures in dual scale. It hangs or stands and bold numbers for easy reading.

- Range: 50° to 300°C (100° to 600°F)
- Accuracy: ±1 division, 10° div.



Candy • Humidity • Timers and Alarms



DTH880
Compact temperature and humidity tester

This unit can be wall mounted or used with a handy built-in tilt stand. It measures humidity from 25 to 95% RH and temperature from 0° to 50°C (32° to 122°F). Features include comfort zone indication and min/max readings. Uses an AAA battery and comes with a 1 Year Limited Warranty.

- Accuracy: ±1°C (2°F), 0° to 40°C (32° to 104°F)
- Humidity: ±5% RH, 40% to 80%, ±7% below 40% or over 80%



CD400K
Candy thermometer

Dishwasher safe, stainless steel construction, adjustable temperature indicator, 2 ¼" dial face, 4 ½" stem, and dual scale reading.

- Range: 40° to 200°C (100° to 400°F)
- Accuracy: ±1 division, 5° div.



CF400K
Candy thermometer

This spirit glass thermometer, constructed of stainless steel, has dual range and a clip on the back.

- Range: 40° to 200°C (100° to 400°F)
- Accuracy: ±1 division, 2° div.



UTL264
Count up and count down timer

Extra large digits make the UTL264 easy to read. The audible buzzer clearly announces when countdown has been reached. Timing capacity of 99 minutes 59 seconds and repeatable memory make this timer a value-added tool. Features easel stand and magnetic clip back. Uses an AAA battery.



UTL884
Mechanical timer

This easy-to-use 60 minute timer has a long-ring bell alarm.

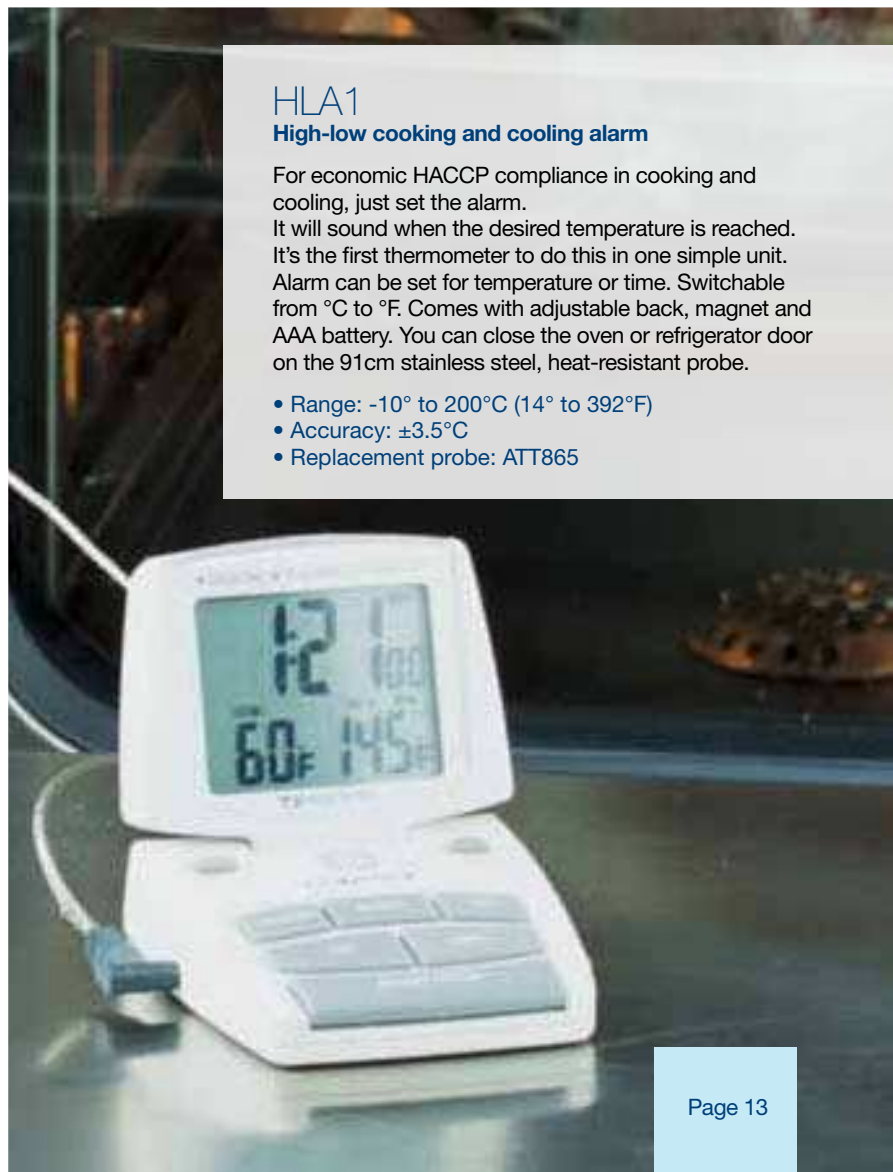

HLA1
High-low cooking and cooling alarm

For economic HACCP compliance in cooking and cooling, just set the alarm. It will sound when the desired temperature is reached. It's the first thermometer to do this in one simple unit. Alarm can be set for temperature or time. Switchable from °C to °F. Comes with adjustable back, magnet and AAA battery. You can close the oven or refrigerator door on the 91cm stainless steel, heat-resistant probe.

- Range: -10° to 200°C (14° to 392°F)
- Accuracy: ±3.5°C
- Replacement probe: ATT865

Infrared Thermometers



FPP FoodPro Plus

Infrared thermometer with an added flip-down Pt100 sensor probe and integral countdown timer.

- Probe Range: -40° to 200°C (-40° to 400°F)
- Probe Accuracy: ±0.5°C (±0.9°F) from -5° to 65°C (+23°F to +150°F)
- Probe is replaceable in the field: FP-Probe
- Infrared Range: -35° to 275°C (-30° to 525°F)
- Distance to Spot Size Resolution (D:S) 2.5:1
- Battery: 9V Alkaline



Safer	Risk Zone	Safer
Chilled and Frozen Storage	Ripening Fermenting Warming-Cooling	Pasteurization Sterilization Conservation Warm Holding
Microorganism growth inhibited	Heavy growth of Microorganisms	Microorganism growth inhibited or destroyed
4°C (40°F)	4°C to 60°C (40°F to 140°F)	60°C (140°F)

Specifications
Sighting
Case
Measurement Range – Infrared
Accuracy
Ratio of Distance Spot to Size
Response Time
Ambient Operating Range
Emissivity (pre-set)
Backlight
Battery
Warranty



FP FoodPro

Quickly scan food surface temperatures using unique target illumination beam.

- “HACCP Check” feature graphically displays critical temperature zones
- Range: -30° to 200°C (-20° to 400°F)
- ±1°C Accuracy from +0° to 65°C or 1.5% of reading
- Emissivity: pre-set at 0.97
- Distance to Spot Size Resolution (D:S) 2.5:1
- Battery: AA Alkaline



KM814FS

Economy infrared thermometer for food service applications

Precisely locate target measurement point through laser sighting. For HACCP temperature measurements at receiving, during cooking, holding and serving.

- Switchable °C/°F with backlight
- Auto switch off
- Single degree resolution
- 7 second display hold
- Distance to Spot Size Resolution (D:S) 4:1
- Optional soft pouch 17275
- ±1°C accuracy in critical food zone, 0°C to 65°C



KM842

Rugged IR thermometer

When surface temperature measurements need to be fast and accurate, the KM842 is hard to beat.

- Perform HACCP temperature measurements at receiving
- Monitor surface temperatures during cooking
- Check hot holding and serving temperatures
- Ensure uniform storage temperatures

FPP	FP	KM814FS	KM842
LED	LED	Single point	Single point
Belt pouch included	n/a	Optional soft pouch 17275	Hard case
-35° to 275°C (-30° to 525°F)	-30° to 200°C (-20° to 400°F)	-30° to 200°C (-25° to 400°F)	-32° to 535°C (-25° to 750°F)
For targets between 0°C and +65°C ± 1°C	For targets between 0°C and +65°C ± 1°C	For targets between 0°C and +65°C ± 1°C	23°C and up, ±1% or ±1°C, whichever is greater
2.5:1	2.5:1	4:1	12:1
500m second	500m second	500m second	500m second
0° to 50°C	0° to 50°C	0° to 50°C	0° to 50°C
10 to 95% RH	10 to 95% RH	10 to 95% RH	10 to 95% RH
0.97	0.97	0.97	0.95
Yes	Yes	Yes	Yes
9V Alkaline	AA Alkaline	9V Alkaline	9V Alkaline
2 years	2 years	1 year	1 year

Wireless Monitoring



RF500

Wireless monitoring system

This system provides effortless 24/7 monitoring of temperature, humidity and door events. Low power RF technology with built-in mesh networking, and transmitters with bi-directional communications offer:

- Accurate, tamper-proof records
- Secure multi-user access to data via the internet at any time
- Alarm notification via email, phone or sms
- Transmitters that are waterproof and accurate with long battery life
- Compliance with legislative and regulatory requirements
- Plus, it's easy to install, use and maintain

Manual checks on temperature and humidity are a thing of the past.

The RF500A employs a system of remote sensors and probes to automatically collect and transmit data to a Gateway unit which manages the system and stores the data.

The RF500A Gateway requires no specialist PC software. It connects directly to the local area network permitting 24/7 single or multi-user access via the internet at any time. The system provides a full audit trail, electronic signatures and data protection to meet the requirements of 21 CFR Part 11.

In the event of readings falling outside pre-set limits, alarm notification via screens, SMS, email or voice contact you immediately, so immediate corrective action can be taken.

Advanced features include: ADR – Automatic Data Retrieval.

In the event of a power failure, data is stored in the RF500A transmitter then automatically transmitted to the Gateway as soon as the network is restored, so no data is lost.

Mesh Network – established through powered transmitters.

This enables the system to automatically adjust to any changes in the environment, rerouting signals as required to ensure that the data is always returned to the Gateway.

Waterproof Transmitters with LCD

Transmitters are fully waterproof and include an LCD for instant data display and an LED for local alarm indication. Low battery indicator on each unit is

viewable via the web. Choose either a model with a 2 year battery life or AC power transformer.

- RF512 has an integral temperature sensor plus connectors for two external thermistor probes and an external door sensor.
- RF513 has integral temperature and humidity sensors and a connector for an external door sensor.
- RF515 has inputs for current and voltage so can be connected to a control loop and programmed to measure an extensive range of parameters.
- RF516 is a precision temperature transmitter with an internal temperature sensor plus connectors for one external PT100 probe and an external door sensor.



RF542 Network logger

- Connect via a port to LAN or WAN anywhere.
- Expand your monitoring system using your existing network.
- The RF500A Gateway hosts any combination of RF500 series collection devices. This includes RF542 data logger wired to the network and RF wireless transmitters stationed within radio range of the Gateway.
- 24/7 Email and SMS alerts.
- Temperature measurement via single or duplex sensor probe.



Specifications

RF500A Gateway	
Channels	Up to 256
Transmitters	Up to 64
Storage capacity	Up to 10 years of storage
RF frequency	2.4 GHz using IEEE 802.15.4
Battery life	1 hour (rechargeable)
Power sources	110-240V adaptor, rechargeable Ni-Mh battery
Clock accuracy	4ppm (2 minutes per year)
Dimensions	L 259mm x W 189mm x H 92mm
Weight	1.3kg

Transmitters – RF512, RF513, RF516

Temperature measurement range

Internal Thermistor Sensor RF512, RF516	-30° to 70°C (-22° to 158°F)
Integral Thermistor Sensor RF513	-30° to 70°C (-22° to 158°F)
External Thermistor Sensor	-40° to 125°C (-40° to 257°F)
External Pt100 Sensor	-200° to 400°C (-328 to 750°F)

System accuracy with standard sensors:

Temperature

External thermistor:	-20°C to +70°C ±0.5°C (0.9°F)
External thermistor:	full range ± 1°C (2°F)
Internal thermistor :	-20°C to +70°C ±0.5°C (1°F)
PT100	full range ±0.05°C/±0.1°F plus probe
Humidity	10 to 90% RH ±3%
Logging memory	32,000 records
Logging frequency	Programmable between 1 and 60 minutes
Monitoring frequency	1 minute
Battery type	Replaceable Lithium 'C' Cell (Part No RFBATT)
Battery life	Up to 2 years (when used at 23°C/73°F) room temperature)
Dimensions	L 170mm x W 83mm x H 34mm
Weight	270g

See our separate brochure on the RF500A system for more details or visit our website.

1. Large LCD allows local view of temperature, RH (RF513), and door opening information plus alarms and RF status
2. LEDs for active/alarm indication
3. Antenna
4. Selectable scales °C or °F, %RH or DP (RF513)
5. Compact, waterproof case with BioCote® antimicrobial surface protection
6. Door event sensor connector
7. AC/Main power connector
8. Secure Lumberg connector for probes

Diligence WiFi Loggers

Temperature & Humidity Data Loggers

Diligence WiFi Data Loggers from Comark provide an easy way to collate temperature data automatically, 24 hours a day, seven days a week. For any organisation involved in providing or serving food to the public, it provides critical visibility of food safety compliance.

Manual temperature collection takes valuable time which could be saved by automation and it also removes the risk of mistakes. An audible alarm provides an alert whenever temperatures fall out of range of preset conditions so corrective action can be taken before valuable stock is put at risk.

As soon as the Diligence WiFi network is set up, temperature or humidity is continually logged and data is transmitted wirelessly via your existing WiFi network to a PC and viewed using the free Diligence WiFi secure software package. When installed the software allows set-up, data logging and data review. Historic data can be viewed via the graphing tool or exported to Excel.

Use Diligence WiFi Loggers to monitor areas such as walk-in and reach-in refrigerators and freezers, cold storage areas, blast chillers, and hot holding cabinets.

- RECHARGEABLE. A full charge lasts 3-12 months
- Easy to self install out of the box
- Connects to existing WiFi networks, no hard wiring required
- Quick to mount in any location
- Use Diligence WiFi secure software to view data and report
- Reliable temperature data 24 hours a day, 7 days a week
- Built-in visual WiFi Signal Meter

Diligence WiFi

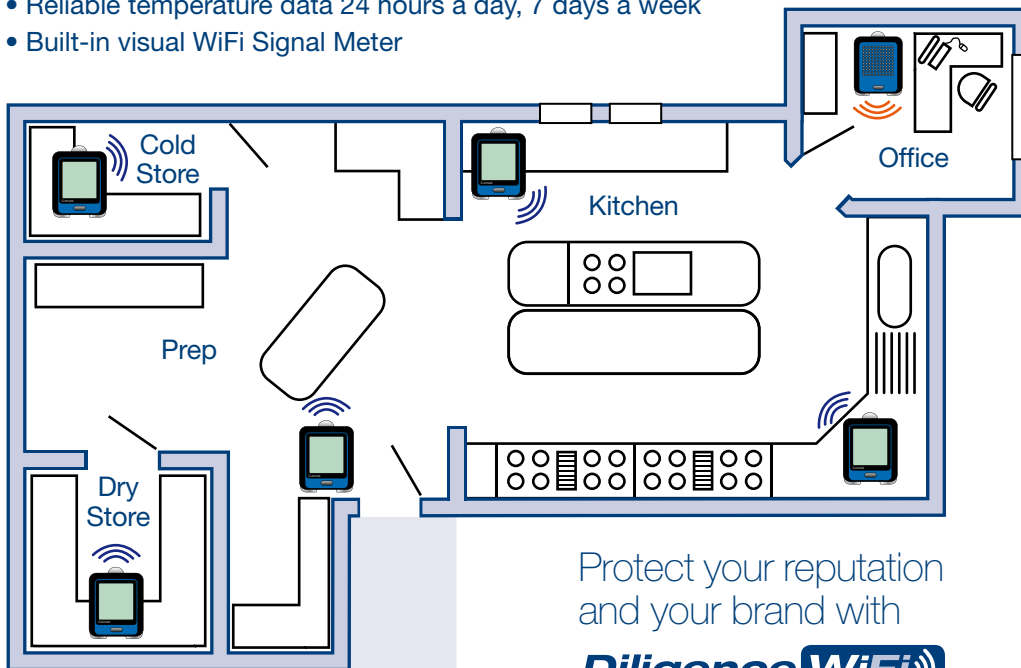

View data and reports on your PC using Diligence WiFi secure software

Protect your reputation and your brand with

Diligence WiFi

Use Diligence WiFi Data Loggers to:

- Monitor walk-in and reach-in refrigerators and freezers
- Check cold storage areas are kept at optimum levels
- Conduct temperature checks on blast chillers
- Ensure safe hot holding temperatures are maintained



RF311-T



RF312-TP



RF313-TH



RF314-TC

Specifications	RF311-T	RF312-TP	RF313-TH	RF314-TC
Temperature measurement range	-20°C to +60°C	-40°C to +125°C (Probe temp range)	-20°C to +60°C	-270°C to 1300°C (probe dependent)
Internal resolution	0.1°C	0.1°C	Temp: 0.1°C Humidity: 1.0 %RH	0.1°C
Temperature accuracy - internal	±0.5°C overall error between -10°C and +50°C	N/A	±0.3 overall error between 0°C and +60°C	N/A
Probe temperature accuracy -10 to +70°C (+14 to +158°F) -40 to +125°C (-40 to +257°F)	N/A	±0.6°C ±1.0°C	N/A	±1.5°C (probe dependent)
Humidity accuracy - overall error between 10 %RH and 90 %RH	N/A	N/A	±2.0 %RH	N/A
Logging rate (user configurable)	Minimum 10 seconds Typical 10 minutes Maximum every 12 hrs	Minimum 10 seconds Typical 10 minutes Maximum every 12 hrs	Minimum 10 seconds Typical 10 minutes Maximum every 12 hrs	Minimum 10 seconds Typical 10 minutes Maximum every 12 hrs
Operating temperature range	-20°C to +60°C	-20°C to +60°C	-20°C to +60°C	-20°C to +60°C
IP Rating	IP55	IP55	IP55	IP55
Battery life	3 - 12 months*	3 - 12 months*	3 - 12 months*	3 - 12 months*

* Depending on frequency of transmissions



RF324
Audible and Visual Alert

Specifications	RF324
Operating temperature range	-20°C to +60°C
IP Rating	IP55
Back-up battery life	2 days
Sound Output	Typical 100 dBA @ 1m

Temperature and Humidity Monitoring

Comark Diligence EV Data Loggers measure both humidity and temperature when monitoring food in storage, transit or processing as well as pharmaceutical and general industrial applications. Models with thermistor sensors offer highest accuracy. K or T-Type thermocouples provide a wide measurement range. With the addition of the N2000BOX, the N2012 can measure up to five separate channels with a single logger using four external probes and one internal sensor. With the N2000ADP/K, the N2014 can measure up to four channels using three external thermocouple probes and one internal sensor.



N2011

N2012

N2013

Features:

- Tough, moulded cases, dust and waterproof to IP67 standards
- Large memory capacity of up to 16,000 readings
- Instrument accuracy of $\pm 0.5^{\circ}\text{C} + 0.3\%$ of reading at $+20^{\circ}\text{C}$
- Ability to log over multiple periods
- Windows™ based Evolution software for fast data download and analysis
- LED indication of active logging and temperature or humidity alarm conditions
- LCD displays on selected models for instant checks on current readings and alarms
- Additional beeper warning of temperature and humidity alarm conditions
- Single-button control of main functions
- Ability to scroll LCD display between readings from all sensors in use
- Wide range of Comark temperature probes available

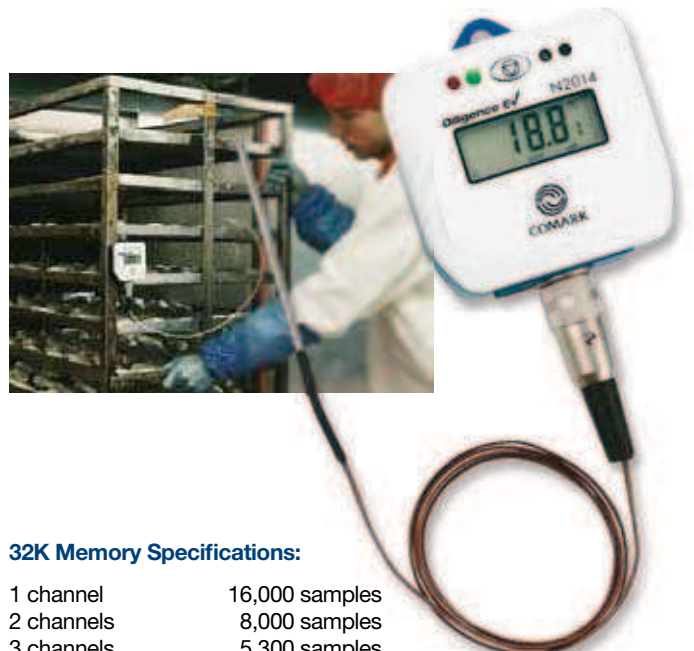

32K Memory Specifications:

1 channel	16,000 samples
2 channels	8,000 samples
3 channels	5,300 samples
4 channels	4,000 samples
5 channels	3,200 samples

Communications	Via infrared interface
Download Time	3 minutes for 10,000 readings (typical)
Logging Frequency	Programmable between 1 second and 99 hours
Battery Life	Up to 5 years
LED Indication	Red = Alarm, Green = Logger active





N2014



N2015



Mapping Kit

Using Diligence EV Data Loggers, temperature mapping can be carried out in storage areas such as fridges, freezers and cold rooms.

- 10 x N2011 Data Loggers
- 10 x UKAS Certificates at -20°, 0°C and +8°C
- 1 x N2014 Data Logger
- 1 x N2000ADP/T Adaptor for multiple probes
- 3 x AT26M Air Probe
- 3 x UKAS Certificates at -40°C and -80°C (for FFP Freezers)
- 1 x N2000CRU USB Computer Interface
- 1 x Case

Diligence EV product line

N2011	Internal temperature sensor with LCD
N2012	Internal temperature sensor and up to 4 external sensors with N2000 Box with LCD
N2013	Single temperature and humidity alarm with LCD
N2014	Thermocouple logger with range of -200°C to +1372°C with N2000ADP/K and appropriate probes with LCD
N2015	4 to 20mA
N2000CRU	Communications interface with USB connection
N2000BOX	Multi-link box to connect up to 4 probes to N2012
N2000ADP/T	Adaptor to connect up to 3 thermocouple probes to N2014
EVS	Standard software
EVS	Software for use with 21CFR Part II
PRO	Penetration probe, 1m long with 10cm stem for N2012
PX31L	Penetration probe, 1m long with stem for N2014
ADP55	USB to Serial Port Adaptor

Measurement range

N2011	
Temperature	-40° to +70°C (-40° to +158°F)
N2012	
Internal sensor	-40° to 70°C (-40° to 158°F)
External sensor	-40° to 150°C (-40° to +302°F)
N2013	
Temperature	-20° to +60°C (-4° to +140°F)
Humidity	0 to 97% RH, non-condensing
N2014	
K-Type	-200° to +1372°C (-328° to +2500°F)
T-Type	-200° to +400°C (-328° to +750°F)
N2015	4 to 20mA

Ev2 Temperature Logger

Multi-Use logger makes it easy to comply with HACCP and USDA requirements by monitoring the temperatures of meat, seafood and produce shipments 24/7.

- Review maximum, minimum and average trip temperatures plus total time in alarm, right on the screen
- Accept or reject a shipment in seconds
- Download data to a PC for permanent HACCP records
- Single button starts/stops logging
- Up to 3,000 readings with 1 sec to 99 hour intervals
- Special software for 21 CFR Part 11 compliance
- BioCote® antimicrobial protection
- Waterproof and rugged IP67 case



Ev2 Range

Ev2	Transport logger, multi-use
EVS	Software, standard
PRO	Software for use with 21CFR Part 11
CRU	PC interface for programming and downloading data with USB connector



Industrial Thermometers

Use Comark industrial thermometers and temperature probes for a range of applications which include scientific research, pharmaceuticals, public health, horticulture, building management, manufacturing, H & V and refrigeration.



N9005 Dual sensor thermometer

This Type T/K thermocouple thermometer is rated IP67 and provides exceptional instrument accuracy. A cell-phone style menu allows selection of scales, clock adjustment and setting the count-down timer.

- -200°C to +1372°C range, depending on sensor
- Accuracy 0.1% \pm 0.2°C across the full measurement range.
- Countdown timer with selectable audible alarms
- Permanent clock display
- Selectable auto switch off – choose 3, 10 or 30 minute interval
- Data hold
- Sub-miniature probe connector
- Scales °C, °F



N9002 Differential thermometer with multi-sensor compatibility

Compatible with 8 thermocouple types – K, N, T, J, R, S, E and B. Twin sub-miniature probe connectors allow differential temperatures to be measured, with readings displayed in °C, °F or K. It can also be used as a conventional thermometer when a single probe is connected.

- -200°C to thermocouple limit
- Single and dual differential inputs
- Maximum and minimum temperature memory
- Data hold
- Selectable 3, 10 or 30 minute auto switch off
- Scales °C, °F and K
- Rated IP67
- Calibration – BS EN 60584 Thermocouples (ITS90)



N8006 with integral temperature and humidity sensor

Use N8006 for applications as diverse as heating and ventilating, the storage of sensitive materials such as paper and fabric, or art galleries and museums where acceptable humidity levels need to be maintained.

- 0 to 100% humidity range
- -20°C to 60°C temperature range
- RH, °C, °F and DP scales
- Accuracy at 0-90% RH: \pm 2%
- Rated IP67



N9002 HVAC Kit

- N9002 Differential Thermometer
- 1 x LC98 Case
- 2 x SK29M Pipe Probes
- 1 x SK21M Surface Probe
- 1 x AK21M Air Probe



KM330 with Type K sensor

An economically priced thermometer with a Type K sensor which extends the upper measurement range to 1300°C. It incorporates a useful maximum temperature memory function and comes complete with a slip-on rubber boot.

- -50°C to +1300°C range
- Sub-miniature probe connector
- Selectable 0.1°/1° resolution
- Max temperature memory
- Data hold
- Scales °C, °F

KM330/P/Kit

- KM330 Thermometer
- 1 x PRO2 Surface Probe
- 1 x PRO4 Flexible Air Probe
- Carrying pouch



KM340

Differential thermometer with Type K sensor

This is a differential measurement version of the KM330 and is ideal for HVAC applications, particularly for flow and return measurements and radiator output checks. It measures two temperature inputs and calculates the difference between them. It can also be used as a conventional single probe thermometer.

- -50°C to +1300°C range
- Two sub-miniature probe connectors
- Max/min temperature memory
- Data hold
- Scales °C or °F
- Resolution 1°



KM330/Legionella Kit (not illustrated)

- KM330 Thermometer
- 1 x PRO1 Penetration Probe
- 1 x PRO2 Surface Probe
- Carrying pouch



Pressure Meters

Accuracy and speed of response, plus ATEX certified Intrinsically Safe options are the factors which define Comark pressure meters.

Comark twin input pressure meters

The C9550 range of pressure meters is suitable for gauge or differential pressure and positive or negative (vacuum) pressure measurement. These instruments are ideal for applications like H & V, process pressures, laboratories and clean rooms, through to service and maintenance and the calibration of other instruments.

The C9500 range is identical to the above in terms of specifications but all instruments are ATEX certified Intrinsically Safe (I.S.) for working in hazardous environments. Certified to Ex II 1 G EEx ia IIC T4 Baseefa03ATEX0079. All C9500 models also have average reading function and over-range indication.

The C9550 offers silicone protection as an option. This allows liquid pressures to be measured without the risk of sensor corrosion. Simply order the version with 'SIL' in the order code.

Four models are offered in each range with measurement parameters 0 to 2PSI, 0 to 5PSI, 0 to 30PSI and 0 to 100PSI. Readings can be displayed in up to 11 different scales depending on the model. See table for options.

Standard instruments

Order codes: C9551, C9553, C9555, C9557

Standard instruments with Silicone Protection

Order codes: C9551/SIL, C9553/SIL, C9555/SIL, C9557/SIL

Intrinsically Safe Instruments

Order codes: C9501/IS, C9503/IS, C9505/IS, C9507/IS



C9500 Series Specifications

SCALE	Standard Intrinsically Safe	C9551 C9501/IS	C9553 C9503/IS	C9555 C9505/IS	C9557 C9507/IS
PSI Range	0 to ± 2.031 Resolution	0 to ± 5.076 0.001	0 to ± 30.46 0.001	0 to ± 101.05 0.001	0.01
mbar Range	0 to ± 140 Resolution	0 to ± 350 0.1	0 to ± 2100 0.1	0 to ± 7000 0.1	1
Bar Range	– Resolution	– –	0 to ± 2.100 –	0 to ± 7000 0.001	0.001
inH₂O Range	0 to ± 56.2 Resolution	0 to ± 140.5 0.01	0 to ± 843.1 0.01	0 to ± 2810 0.1	0.1
inHg Range	0 to ± 4.134 Resolution	0 to ± 10.34 0.001	0 to ± 62.01 0.001	0 to ± 206.7 0.01	0.01
mmHg	Range Resolution	0 to ± 105.0 0.01	0 to ± 262.5 0.01	0 to ± 1575 0.1	0 to ± 5250 1
Torr Range	0 to ± 105.0 Resolution	0 to ± 262.5 0.01	0 to ± 1575 0.01	0 to ± 5250 0.1	1
Pa	Range Resolution	0 to ± 14000 1	– –	– –	– –
KPa Range	0 to 14.00 Resolution	0 to ± 35.00 0.001	0 to ± 210.0 0.01	0 to ± 700.0 0.01	0.1
mmH₂O	Range Resolution	0 to ± 1428 0.1	0 to ± 3569 1	– –	– –
cmH₂O	Range Resolution	0 to ± 142.8 0.01	– –	0 to ± 2141 0.1	0 to ± 7138 1
Kgcm⁻²	Range Resolution	0 to ± 143 0.001	0 to ± 0.357 0.001	0 to ± 2.141 0.001	0 to ± 7.138 0.001



Calibration Instruments

Temperature and measurement instrument performance is vital in almost every application, especially throughout the food industry.

Performance can be affected by many factors including use and abuse and the age of the instrument. Regular, professional calibration checks are recommended, with certification as required, especially for companies with HACCP procedures and other quality systems. In the meantime, calibration can be monitored with Comark simulators, reference thermometers and validation equipment.



KM820/VAL Validator

Use this heavy duty aluminum cup (shown above) to check the calibration of infrared or contact thermometers.

- Also available in a calibration check kit with the KM20REF reference thermometer and carrying case.



KM20REF Kit Reference Thermometer Kit

Use this high-accuracy reference thermometer for checking the calibration of all types of thermometer and probe combinations.

- PT100 sensor and permanently attached probe for highest system accuracy
- Complete with 5-Point UKAS Certificate of Calibration
- Auto switch off
- Supplied with hard carrying case
- Includes KM820/VAL Validator



For more information call 0844 815 6599
www.comarkinstruments.com

Stop!

Think how your business could benefit from BioCote® protected instruments.



All the latest Comark instruments are manufactured with BioCote® antimicrobial technology impregnated into the instrument surfaces, keypads and probe handles.

The technology utilises silver, a natural antimicrobial that helps prevent the growth of bacteria, mould and fungi and lasts for the life of the instrument. When micro-organisms come into contact with a Biocote® protected surface their growth is inhibited, reducing microbial populations resulting in a more hygienic product.

A trial by BioCote Ltd and The University of Wolverhampton Science Park canteen was

conducted to compare micro-organism levels on a BioCote® treated Comark thermometer with an untreated thermometer. The trial was carried out over an 8 week period.

Swabs were taken from the thermometer case, keypad and probe handle before and after each use and the number of contaminating bacteria was counted. The treated instrument showed a dramatic reduction in microbe levels, proving beyond doubt that BioCote® protected instruments are significantly cleaner and safer to use in sensitive environments.



The actual result was a massive 92.73% reduction in microbe levels!

Temperature Probes



Comark produces one of the largest available ranges of temperature probes, with a probe for almost every application.

Comark can certify temperature probes, either alone, or, as recommended, with an instrument to record system accuracy. Certificates of calibration are supplied through the Comark in-house UKAS accredited temperature calibration laboratory and the in-house NPL traceable laboratory.

The Comark Service Team or your local distributor can offer advice on probes and certification and can provide detailed quotations.

COMARK ORDER CODES

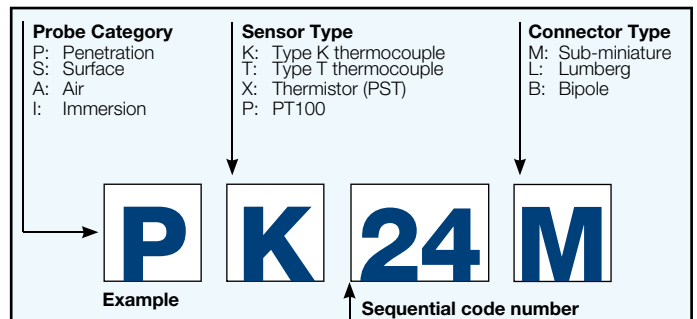

CONNECTOR TYPES

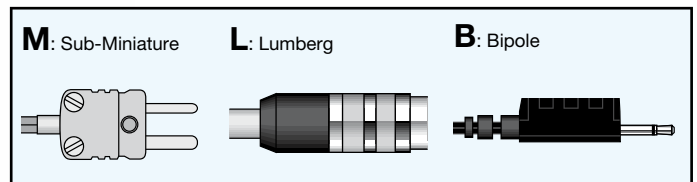

Probe leads

Comark probe leads are matched to the intended applications for the probe. The materials used are:

PVC – PVC coiled leads provide ease of use in ambient temperatures of up to +70°C.

FEP and PTFE – These materials are especially suited to food probes and can be used in sub-zero temperatures. Steel braided PTFE leads provide greater strength.

Fibreglass (FG) – Fibreglass insulated leads are used for special application probes where the lead could be subjected to very high ambient temperatures of up to +400°C.

Penetration Probes

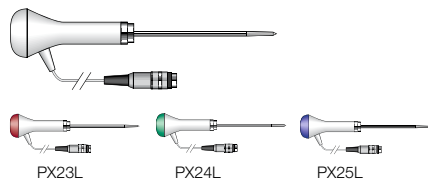

Sensor	Connector	Temp Range °C	Response Time (secs)†	Stem Length (mm)	Stem Dia (mm)	Lead Length (m)	Lead Material	Code
PST	L	-40°C to +150°C	5.0	100	3.3	0.7	FEP	PX22L‡
PST	L	-40°C to +150°C	5.0	100	3.3	0.7	FEP	PX23L‡
PST	L	-40°C to +150°C	5.0	100	3.3	0.7	FEP	PX24L‡
PST	L	-40°C to +150°C	5.0	100	3.3	0.7	FEP	PX25L‡
T	L	-100°C to +250°C	2.0	100	3.3	0.7	PTFE	PT24L‡

For incorporating into your HACCP plan, these food penetration probes with coloured end caps minimise the risk of cross contamination. PX22L White, PX23L Red, PX24L Green, PX25L Blue. PT24L - Type T sensor food probe with steel braided lead. PX22L, PX23L, PX24L, PX25L, PT24L available with 1.0m PVC coiled lead, add /C to order code eg PX22L/C.



PST	L	-40°C to +150°C	0.5	100	1.6	0.7	FEP	PX16L‡
T	L	-100°C to +250°C	0.5	100	1.6	0.7	PTFE	PT23L‡

PX16L - Fast response thermistor food probe.
PT23L - Fast response Type T food probe with steel braided lead.

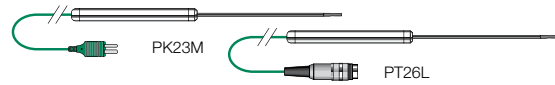

K	M	-50°C to +250°C	2.0	100	3.3	2.5	PTFE	PK23M
T	L	-100°C to +250°C	2.0	100	3.3	2.5	PTFE	PT26L‡

Oven meat probe for checking meat and food temperatures during cooking.



T	L	-100°C to +250°C	2.0	100	2.4	-	-	PT25L‡
PST	L	-40°C to +150°C	5.0	100	3.3	-	-	PX33L‡



PST	L	-40°C to +150°C	2.0	75	3.3	1.0	FEP	PX31L‡
T	L	-100°C to +250°C	2.0	75	3.3	1.0	FEP	PT31L‡
K	L	-100°C to +250°C	2.0	75	3.3	1.0	FEP	PK31L‡
T	L	-100°C to +250°C	4.0	140	8.0	1.0	PVC	PT29L‡

Corkscrew probe for frozen foods.

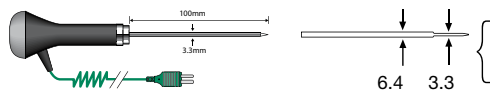
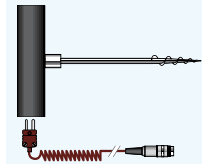

K	M	-50°C to +250°C	2.0	100	3.3	1.0	PVC	PK24M
K	M	-50°C to +250°C	2.0	300	3.3	1.0	PVC	PK29M
K	M	-50°C to +250°C	4.0	300	6.4/3.3	1.0	PVC	PK27M
T	L	-100°C to +250°C	4.0	150	6.4/3.3	1.0	FEP	PT28L‡
PST	L	-40°C to +150°C	10.0	150	6.4/3.3	1.0	FEP	PX30L‡
T	M	-100°C to +250°C	2.0	100	3.3	1.0	PVC	PT22M
T	L	-100°C to +250°C	0.5	100	1.5	1.0	PVC	PT19L
K	M	-50°C to +250°C	0.2	100	1.5	1.0	PVC	PK19M
K	M	-50°C to +250°C	0.2	70	1.1	1.0	PVC	PK15M

Standard and heavy duty industrial probes.

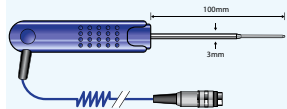

Surface Probes

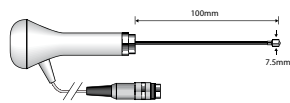

T	L	-100°C to +250°C	0.2	100	7.5	0.7	PTFE	ST21L‡
---	---	------------------	-----	-----	-----	-----	------	--------

Ribbon type surface probe with steel braided leads for food applications.

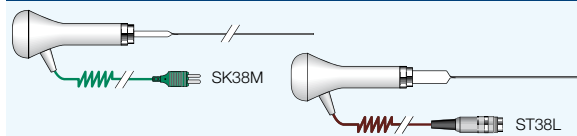

K	M	-50°C to +250°C	4.0	250	8 x 2	1.0	PVC	SK38M
T	L	-100°C to +250°C	4.0	250	8 x 2	1.0	PVC	ST38L‡

Heavy duty pallet probes.

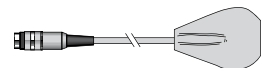

T	L	-40°C to +70°C	5.0	-	-	1.0	PTFE	ST23L‡
PST	L	-40°C to +70°C	15.0	-	-	1.0	FEP	SX23L‡

Between pack temperature probes. ST23L and ST24L with steel braided leads.

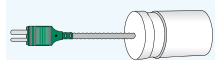

K	M	to +260°C	-	-	-	1.0	-	SK40M‡
---	---	-----------	---	---	---	-----	---	--------

Griddle probe.

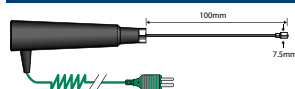

K	M	-50°C to +250°C	0.2	100	7.5	1.0	PVC	SK21M
---	---	-----------------	-----	-----	-----	-----	-----	-------

General purpose probe.

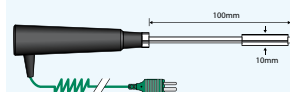





K	M	-50°C to +650°C	0.4	100	10.0	1.0	PVC	SK24M
---	---	-----------------	-----	-----	------	-----	-----	-------

General purpose probe.

†The time constant is the time taken for the probe to reach 63% of the value of the temperature change. Multiply x 3 for the time taken to achieve 95% and by 5 for 99%.

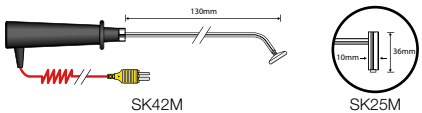
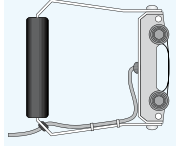
‡Not suitable for Intrinsically Safe applications. Thermocouples:- Tolerances relate to BS EN60584-2 (1993), Class A. All dimensions are in mm.

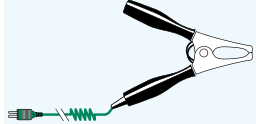
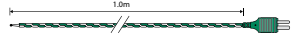
Temperature Probes

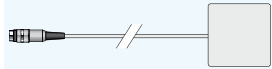
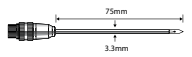
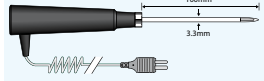
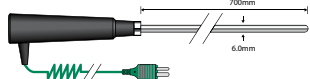
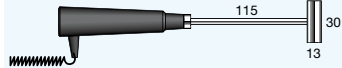
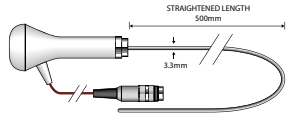
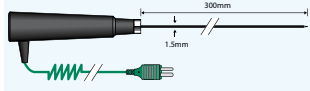
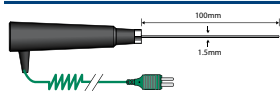
Surface Probes		Sensor	Connector	Temp Range °C	Response Time (secs)†	Stem Length (mm)	Stem Dia (mm)	Lead Length (m)	Lead Material	Code
 <p>SK42M SK25M</p>	K	M	-50°C to +250°C	0.4	130	10.0	1.0	PVC	SK42M	
	K	M	-50°C to +650°C	0.4	150/36	10.0	1.0	PVC	SK25M	
	K	M	-50°C to +250°C	2.0	148	-	2.0	PVC	SK28M‡	
Roller probe for stationary or moving surfaces including cylinders and flat surfaces. Measures at up to 600m/min surface speed and from 125mm diameter curved to flat surfaces.										
	K	M	-50°C to +100°C	10.0	-	-	2.5	PVC	SK29M‡	
Pipe probe for heating, ventilating and air conditioning applications with 500mm Velcro strap.										
	K	M	-50°C to +100°C	5.0	-	-	1.0	PVC	SK35M‡	
Pipe clamp probe for use in heating, ventilating and air conditioning applications, for pipes 15 to 38mm diameter.										
Air Probes										
 <p>Flexible thermocouples.</p>	K	M	-100°C to +250°C	0.5	-	-	1.0	PTFE	AK28M	
	T	M	-100°C to +250°C	2.0	-	-	1.0	PTFE	AT26M	
	K	M	-100°C to +250°C	0.5	-	-	5.0	PTFE	AK29M	
	K	M	-100°C to +250°C	0.5	-	-	10.0	PTFE	AK31M	
	K	M	-100°C to +400°C	0.5	-	-	1.0	FG	AK33M	
 <p>Fast response flexible probe with steel braided lead.</p>	T	L	-100°C to +250°C	0.4	-	-	1.0	PTFE	AT26L	
	T	L	-100°C to +250°C	2.0	-	-	1.0	PTFE	AT22L‡	
 <p>Flexible probes.</p>	PST	L	-40°C to +70°C	10	-	-	1.0	FEP	AX24L‡	
	PST	L	-40°C to +70°C	100	-	-	2.0	FEP	DX31L‡	
Food simulant probes for long-term measurements of food in fridges and freezers.										
 <p>Integral plug probe.</p>	T	L	-100°C to +250°C	0.4	75	3.3	-	-	AT25L‡	
 <p>General purpose air probes.</p>	K	M	-100°C to +850°C	0.5	100	3.3	1.0	PVC	AK21M	
	K	M	-100°C to +250°C	0.4	100	3.3	1.0	PVC	AK27M	
 <p>Semi-flexible high temperature air probes.</p>	K	M	-100°C to +1100°C	3.0	700	6.0	1.0	PVC	AK24M	
	K	M	-100°C to +1100°C	3.0	1000	6.0	1.0	PVC	AK25M	
 <p>Shrouded air probe for use in air currents.</p>	K	M	-30°C to +120°C	0.5	115/30	13	1.0	PVC	AK26M	
Immersion Probes										
 <p>Deep fat probe with flexible stem for food applications.</p>	T	L	-200°C to +400°C	1.0	500	3.0	0.7	PTFE	IT21L‡	
 <p>Weighted milk dip probe for dairy applications, also suitable for other liquid dip applications.</p>	T	M	-40°C to +150°C	2.0	90	-	2.0	PTFE	IT23M	
	T	L	-40°C to +150°C	2.0	90	-	2.0	PTFE	IT23L‡	
	PST	L	-40°C to +150°C	5.0	90	-	2.0	FEP	IX23L‡	
 <p>Probes with type K and T thermocouple sensors also have mineral insulated, semi-flexible stems.</p>	K	M	-100°C to +850°C	0.4	100	1.5	1.0	PVC	IK21M	
	K	M	-100°C to +850°C	0.4	300	1.5	1.0	PVC	IK23M	
	K	M	-100°C to +1100°C	1.0	300	3.0	1.0	PVC	IK24M	

†The time constant is the time taken for the probe to reach 63% of the value of the temperature change. Multiply x 3 for the time taken to achieve 95% and by 5 for 99%.
 ‡Not suitable for Intrinsically Safe applications. Thermocouples:- Tolerances relate to BS EN60584-2 (1993), Class A. All dimensions are in mm.

°C	°F
1820	3308
1767	3213
1372	2502
1300	2372
1200	2192
1100	2012
1000	1832
850	1562
800	1472
760	1400
700	1292
650	1202
600	1112
545	1013
500	932
450	842
400	752
260	500
250	482
200	392
190	374
150	302
140	284
125	257
120	248
110	230
100	212
90	194
88	190
85	185
80	176
75	167
70	158
65	149
63	145
60	140
50	122
40	104
28	82
23	73
20	68
8	46
5	41
3	37
2	36
1	34
0	32
-1	30
-5	23
-10	14
-18	0
-20	-4
-25	-13
-30	-22
-32	-26
-40	-40
-50	-58
-55	-67
-80	-112
-100	-148
-200	-328

CONVERSION FORMULA

GLOSSARY OF TERMS

ATEX: Atmosphère Explosive. Refers to the current standards for Intrinsically Safe equipment.

Baseefa: Refers to Baseefa 2001 Ltd, the notified body for Comark ATEX compliance.

Differential Measurement: Ability of an instrument to measure temperature, pressure etc. simultaneously from two different points and to calculate the difference between them.

Distance to Spot Size Ratio: The measure of the increase in the target area diameter detected by an infrared thermometer, over the distance from instrument to target surface.

Emissivity: The natural level of infrared radiation from the surface of any material. Emissivity is measured on a scale from 0.1 to 1.0, where 1.0 represents the radiation from a black body.

HACCP: Hazard Analysis and Critical Control Point. The quality system used throughout the food industry to ensure safe food.

HVAC: Heating, Ventilating and Air Conditioning.

IP Rating: Set of standards for dust and waterproof protection. Many Comark instruments are rated at IP67.

Lumberg: Connector with locking screw, used to provide strong, secure probe-to-instrument connections with better prevention of liquid ingress.

NPL: The National Physical Laboratory.

Operating Range: Temperature and humidity limits within which an instrument will function correctly.

Pt100: Platinum resistance thermometer. High accuracy temperature sensor.

“Quick” Calculations: Pre-programmed calculations available in software, such as average or standard deviation.

Resolution: Indicates the smallest difference in measurements that can be detected and displayed by the instrument, e.g. 0.1° indicates that the instrument can detect differences of one tenth of a degree. In some cases there can be a difference between the detected measurement change and the displayed change.

Sub-miniature: Two-pin industry standard connector.

System Accuracy: Temperature accuracy level for the instrument and probe combined. Instrument accuracy excludes the probe.

Thermistor: Type of temperature sensor offering accuracy suitable for food applications.

Thermocouple: Type of temperature sensor using bi-metal electrical properties. Eight types of bi-metal combinations are available: – K, N, T, J, R, S, E and B – with different measurement ranges and characteristics to suit different applications.

UKAS: The United Kingdom Accreditation Service.

Wraparound: Ability to program a data logger to continue logging when its memory is full, by logging new readings over the oldest readings already in the memory.

THERMOCOUPLE LIMITS

Type	Temperature Range	Type	Temperature Range
K	-200°C to +1372°C	R, S	-50°C to +1767°C
N	-200°C to +1300°C	E	-200°C to +1000°C
T	-200°C to +400°C	B	0°C to +1820°C
J	-200°C to +1200°C		



PDQ400

Waterproof, field calibratable with a thin 1.5mm tip



Warranty

All Comark instruments have a minimum one year warranty unless otherwise stated. The warranty for temperature probes is six months and all other probes are unwarranted because the conditions of use are beyond our control. The Comark Warranty covers manufacturing defects and component failure and applies worldwide. In line with our policy of continuous development, we reserve the right to alter any product specifications without notice. Comark has an accredited UKAS (NIST equivalent) calibration laboratory for temperature and humidity measurement and offers full service and recalibration facilities.

Comark Instruments are committed to providing quality and affordable products to the food service industry. Our thermometers and humidity testers bring speed, accuracy and reliability to the transport, testing and storing of food under HACCP guidelines. A large variety of products, a well-trained staff, and a commitment to customer satisfaction mean you can come to us for answers to all your temperature measurement needs!



**IMPROVED
NOW
EN13485:2002
CERTIFIED**

C22

Dual Sensor - T-Type thermocouple and thermistor



To contact us

For Sales and Admin

Telephone: **0844 (+44 844) 815 6599**

The Sales Office phones are open from 8.45am to 5.00pm weekdays. Call us for help and advice to find the right solution. Alternatively, you can arrange a site visit from one of our experienced Field Sales Team.

Or you can email:

sales@comarkinstruments.com

Or click on **www.comarkinstruments.com**

for full product details or to buy online.

For Service and Calibration

Telephone: **01603 (+44 1603) 256 647**

Or you can email:

service@comarkinstruments.com

or Fax **01603 (+44 1603) 256 744**

Or write to:

Comark Instruments
52 Hurricane Way
Norwich
Norfolk
NR6 6JB
UK

Comark Instruments
PO Box 500
Beaverton
OR 97077
USA



COMARK

A Fluke Company